

Light Water Reactor Sustainability Program

Advanced Seismic Soil Structure Modeling

Chandu Bolisetti
Justin Coleman

June 2015



U.S. Department of Energy
Office of Nuclear Energy

DISCLAIMER

This information was prepared as an account of work sponsored by an agency of the U.S. Government. Neither the U.S. Government nor any agency thereof, nor any of their employees, makes any warranty, expressed or implied, or assumes any legal liability or responsibility for the accuracy, completeness, or usefulness, of any information, apparatus, product, or process disclosed, or represents that its use would not infringe privately owned rights. References herein to any specific commercial product, process, or service by trade name, trade mark, manufacturer, or otherwise, does not necessarily constitute or imply its endorsement, recommendation, or favoring by the U.S. Government or any agency thereof. The views and opinions of authors expressed herein do not necessarily state or reflect those of the U.S. Government or any agency thereof.

Advanced Seismic Soil Structure Modeling

**Chandu Bolisetti
Justin Coleman**

June 2015

**Idaho National Laboratory
Nuclear Science & Technology
Idaho Falls, Idaho 83415**

<http://www.inl.gov>

**Prepared for the
U.S. Department of Energy
Office of Nuclear Energy
Under DOE Idaho Operations Office
Contract DE-AC07-05ID14517**

EXECUTIVE SUMMARY

The goal of this effort is to compare the seismic core damage frequency obtained by a traditional nuclear power plant seismic probabilistic risk assessment (SPRA) and an advanced SPRA that utilizes Nonlinear Soil-Structure Interaction (NLSSI) analysis. Soil-structure interaction (SSI) response analysis for a traditional SPRA uses linear geometric properties (soil and structure are glued together i.e. soil takes tension when structure uplifts), linear soil properties, and linear structure properties. The NLSSI analysis will consider geometric nonlinearities.

Risk calculations should focus on providing best estimate results, and associated insights, for evaluation and decision-making. Specifically, seismic probabilistic risk assessments (SPRAs) are intended to provide predictions of possible combinations of structural and equipment failures that can lead to a seismic induced core damage event. However, in some instances the current SPRA approach has large uncertainties and conservatisms, and potentially masks other important events (for instance, it was not just the seismic motions that caused the Fukushima core melt events, but the tsunami ingress into the facility).

SPRA's are performed by convolving the seismic hazard (this is the estimate of all likely damaging earthquakes at the site of interest) with the seismic fragility (the conditional probability of failure of a structure, system, or component (SSC) given the occurrence of earthquake ground motion). In this calculation, there are several main pieces to seismic risk quantification: site specific seismic hazard and the nuclear power plant (NPPs) response to the hazard, fragility (or capacity of SSCs), and systems analysis.

Two areas where NLSSI effects may be important in SPRA calculations are, 1) when calculating in-structure response at the area of interest, and 2) calculation of seismic fragilities (current fragility calculations assume a simple lognormal distribution for probability of failure of components).

Some important effects when using NLSSI in the SPRA calculation process include, 1) gapping and sliding, 2) inclined seismic waves coupled with gapping and sliding of foundations atop soil, 3) inclined seismic waves coupled with gapping and sliding of deeply embedded structures, 4) soil dilatancy, 5) soil liquefaction, 6) surface waves, 7) buoyancy, 8) concrete cracking and 9) seismic isolation

The focus of the research task presented in this report is on implementation of NLSSI into the SPRA calculation process when calculating in-structure response at the area of interest. Two specific nonlinear effects included in this report are localized soil nonlinearity and gapping and sliding. Other NLSSI effects are not included in the calculation. The results presented in this report document initial model runs in the linear and nonlinear analysis process. Final comparisons between traditional and advanced SPRA will be presented in the September 30th deliverable.

CONTENTS

1. Introduction	7
1.1 Overview	7
1.2 LS-DYNA	7
2. Numerical modeling and analyses	8
2.1 A representative nuclear power plant structure	8
2.1.1 Modal analysis	9
2.1.2 Fixed-base response-history analysis.....	9
2.1.2.1 Practical issues faced	10
2.1.2.2 Results of fixed-base analyses	12
2.2 Soil-structure interaction analysis	13
2.2.1 Modeling	14
2.2.2 Linear analysis	17
2.2.3 Nonlinear analysis.....	19
3. Conclusions	24
4. References	25

ACRONYMS

DBE	Design Basis Earthquake
DOE	Department of Energy
INL	Idaho National Laboratory
NLSSI	Nonlinear Soil Structure Interaction
NNSA	National Nuclear Security Administration
NRC	Nuclear Regulatory Commission
SASSI	System for Analysis of Soil Structure Interaction
SCDF	Seismic Core Damage Frequency
SSI	Soil-Structure Interaction

1. Introduction

1.1 Overview

The estimate of the seismic hazard at nuclear facilities continues to evolve and generally leads to an increase in the hazard. The change in understanding of the site-specific seismic hazard curve occurs as more information is gathered on seismic sources and events, and additional research is performed to update attenuation relationships and characterize local site effects. As the seismic hazard increases, more intense input ground motions are used to numerically evaluate nuclear facility response. This results in higher soil strains, increased potential for gapping and sliding and larger in-structure responses. Therefore, as the intensity of ground motions increases, the importance of capturing nonlinear effects in numerical SSI models increases.

The seismic design of nuclear facilities should be conservative and seismic risk calculations should be best estimate (to minimize the possibility of masking other concerns). Seismic risk calculations focus on beyond design basis earthquake (BDBE) ground motions that are larger in amplitude than design basis earthquake (DBE). Nonlinear effects are more likely during BDBE and therefore consideration of these effects in SPRAs are likely important (Coleman, 2014).

The goal of this effort is to compare the seismic core damage frequency obtained by a traditional nuclear power plant seismic probabilistic risk assessment (SPRA) and an advanced SPRA that utilizes Nonlinear Soil-Structure Interaction (NLSSI) analysis. Soil-structure interaction (SSI) analysis in traditional SPRA involves the use of linear geometric properties (soil and structure are glued together, namely, the soil undergoes tension when structure uplifts), linear soil properties, and linear structure properties. The NLSSI analysis of this study will consider geometric nonlinearities.

The focus of the research task presented in this report is on implementation of NLSSI into the SPRA calculation process when calculating in-structure response at the area of interest. Two specific nonlinear effects included in this report are localized soil nonlinearity and gapping and sliding. Other NLSSI effects are not included in the calculation. The commercial software program, LS-DYNA, is used for the NLSSI analyses.

The results presented in this report document initial model runs in the linear and nonlinear analysis process. Final comparisons between traditional and advanced SPRA will be presented in the September 30th deliverable.

1.2 LS-DYNA

LS-DYNA is a commercial finite-element program, currently developed and maintained by the Livermore Software Technology Corporation (LSTC). It is predominantly used for solving structural mechanics problems using the explicit integration algorithm, which makes it suitable for applications involving sudden loads (crash and blast simulations) and contact problems. The implicit integration algorithm is also implemented in LS-DYNA, but with limited capabilities. LS-DYNA includes a large database of material models for simulating soil and structure (especially steel and concrete), contact interfaces and seismic isolators. LS-DYNA has seen increasing usage in the civil engineering industry with applications in nonlinear site-response, and soil-structure interaction (SSI) analyses of buildings, bridges and LNG tanks (Willford *et al.*, 2010). LS-DYNA is therefore considered a suitable choice for nonlinear SSI analysis of this study.

2. Numerical modeling and analyses

2.1 A representative nuclear power plant structure

The selected representative NPP structure is a pressurized water reactor building. The numerical model of this structure is obtained from the SASSI2000 user manual. It consists of a pre-stressed concrete containment structure and a reinforced concrete internal structure. The numerical models of both the containment and internal structures are idealized stick models illustrated in the left panel of Figure 2-1. Median values of lumped masses and section properties of the stick models are presented in the right panel of this figure. These lumped masses include the masses of the stick elements apart from the masses of the non-structural components at each level. Therefore a zero mass density is assigned for the concrete material in the internal and containment structures. A median elastic modulus of 6.9×10^5 ksf and a median shear modulus of 2.7×10^5 ksf are assumed for the concrete material. However the concrete modulus of the internal structure is reduced by a factor of 0.5 to obtain a fundamental frequency near the peak of the UHS and therefore amplify the structural response. The CLASSI model of the representative NPP structure is identical to this SASSI2000 model.

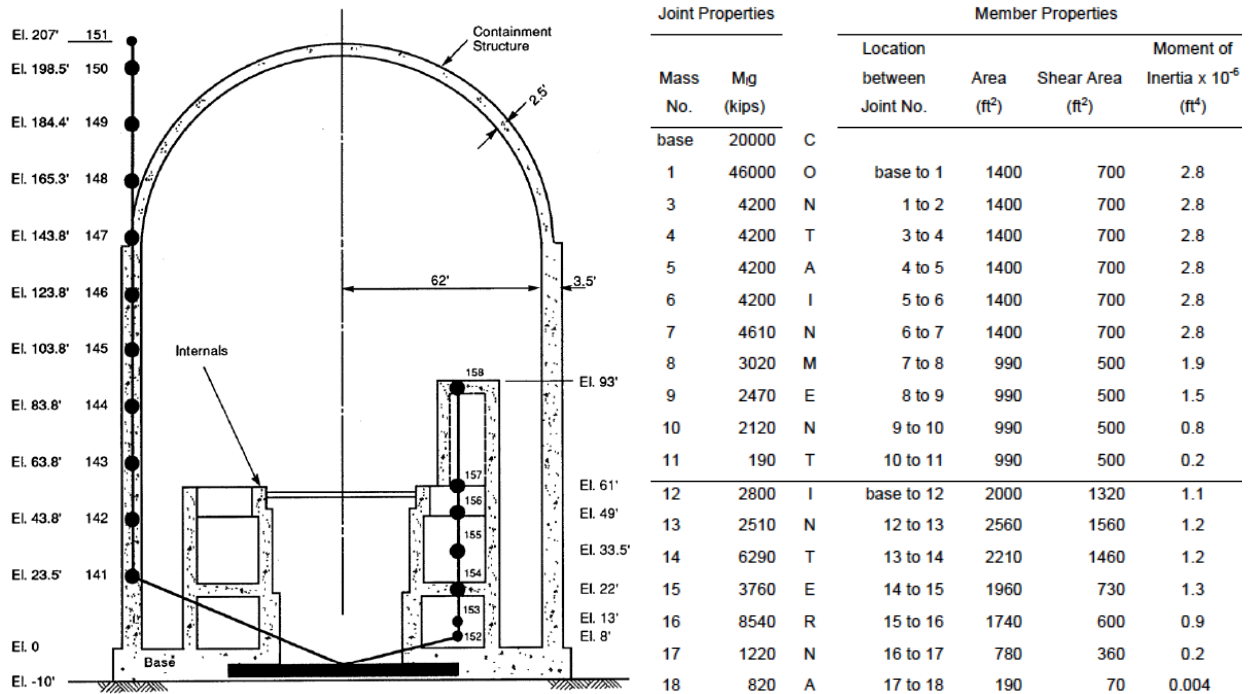

Figure 2-1: Illustration of the representative NPP structures and the corresponding stick models (left) and section properties and lumped masses of the stick model (right)^a (Ostadan, 2006)

^a The lumped mass value of mass no. 3 is 4600 kips and not 46000, and mass no. 2, which is omitted in the table is equal to 4200 kips.

2.1.1 Modal analysis

The LS-DYNA model of the representative NPP structure is built using the Belytschko-Schwer resultant beam elements (beam element type 2) and assigning the cross-section properties presented in Figure 1. Note that assigning a zero mass density is not possible in LS-DYNA (unlike in CLASSI and SASSI) and a small value of 10^{-4} kip-sec²/ft⁴ (actual mass density of concrete is 0.0047 kip-sec²/ft⁴) is used instead. A fixed-base, modal analysis is performed for the representative NPP structure and the modal frequencies, mass participations and mode shapes of the first 15 modes are calculated. The modal frequencies are presented in Table 2-1 below, along with the frequencies calculated by SGH using the structural analysis code, SAP2000 (Computers and Structures Inc., 2011). The modal frequencies calculated using SAP2000 and LS-DYNA are clearly identical. The mass participations, and mode shapes (not presented here) calculated using the two programs are also almost identical.

Table 2-1: Modal frequencies of the representative NPP structure calculated using SAP2000 and LS-DYNA

Mode	Modal Frequency (Hz)		Description
	CLASSI/ SAP2000	LS-DYNA	
1, 2	5.27	5.26	Containment, 1 st horizontal mode
3, 4	8.46	8.45	Internal, 1 st horizontal mode
5, 6	12.37	12.37	Internal, 2 nd horizontal mode
7	15.64	15.64	Containment, 1 st vertical mode
8, 9	16.24	16.24	Containment, 2 nd horizontal mode
10	27.83	27.83	Internal, 1 st vertical mode
13, 14	32.89	32.89	Internal, 2 nd horizontal mode

2.1.2 Fixed-base response-history analysis

After verifying the modal frequencies, a fixed-base RHA is performed with one set of acceleration inputs (three components), and the LS-DYNA responses at key locations in the NPP structure are compared with those calculated by SGH using CLASSI. The stick model used for modal analysis is also used for the RHA. Input ground motions are applied at the base of the structure as prescribed accelerations, and a Rayleigh damping of 5% (median damping ratio of the structure) is specified in the frequency range of 5Hz to 35Hz. Rayleigh damping is modeled in LS-DYNA by specifying the mass damping coefficient using the *DAMPING_PART_MASS card, and the stiffness damping coefficient using *DAMPING_PART_STIFFNESS card. The mass and stiffness damping coefficients are calculated through a trial-and-error procedure to achieve roughly 5% damping in the frequency range specified above.

Since LS-DYNA employs an explicit integration algorithm for RHA, it requires that the time step be less than a critical time step. The critical time step of a model is governed by its stiffness

element (beam, solid, shell or any other element) and is equal to the duration of propagation of a wave through this element (Bathe, 1996; LSTC, 2009). In the case of beam elements, the critical time step is directly proportional to the square root of the mass density of the beam material. For this reason, a small value of mass density (e.g., 10^{-4} kip-sec²/ft⁴ used for modal analysis) can drastically reduced the critical time step and increase the computation time. In order to avoid large computation times in the RHA, the beam material density is increased to 0.0047 kip-sec²/ft⁴, which is equal to the actual material density of concrete. The lumped masses at the nodes are then adjusted compensate for the increased mass density of the beams, assuming that the mass of each beam is equally lumped to the two beam nodes. Sample results of the RHA performed using this approach are presented in Figure 2-2 below. The results present the 5% damped acceleration response spectra of the internal structure at an elevation of 22ft in the X direction.

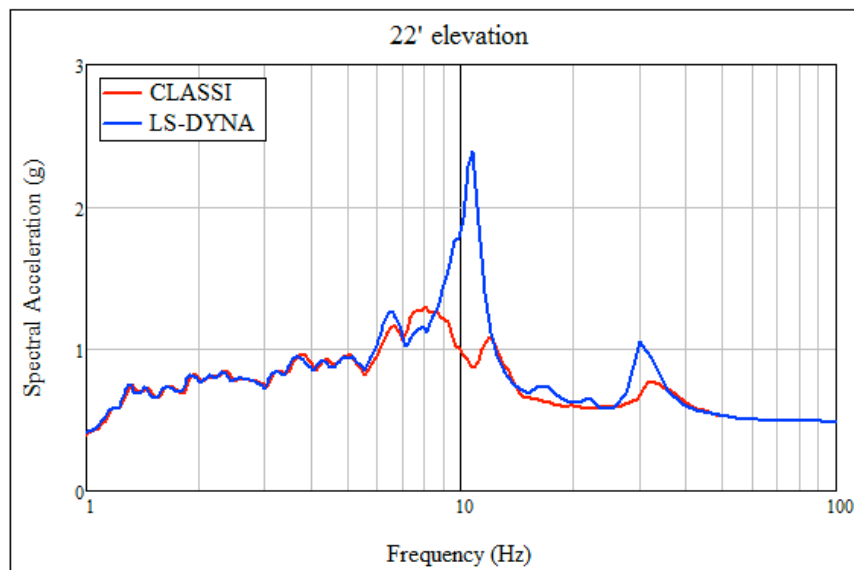

Figure 2-2: Spectral acceleration in the internal structure at 22 ft elevation calculated using CLASSI and a preliminary model in LS-DYNA

Figure 2-2 shows that the structural responses calculated using CLASSI and LS-DYNA are very different, in spite of the models using identical properties and having identical modal frequencies. Further investigation into these differences revealed some issues with modeling in LS-DYNA as described below.

2.1.2.1 Practical issues faced

Figure 2-2 shows that the response spectrum calculated from the LS-DYNA results differs from that calculated using CLASSI in two aspects: 1) the peak spectral acceleration calculated using LS-DYNA is significantly higher and 2) the frequency of this peak spectral acceleration (about 11 Hz) is considerably higher. These differences indicate that the damping in LS-DYNA is not accurately simulated, and that the natural frequencies of the RHA model do not match with those calculated in the modal analysis (1st mode frequency of the internal structure is about 8.5Hz; see Table 1). After a detailed investigation that included performing element level

analyses in LS-DYNA, performing SASSI (Lysmer *et al.*, 1999) analyses, and consultations with other LS-DYNA users (Robert Spears, Personal Communication, 2015) and the LS-DYNA technical support (Ushnish Basu, Personal Communication, 2015), the following errors were recovered from the preliminary LS-DYNA model and fixed:

1. Modeling Rayleigh damping: Rayleigh damping in LS-DYNA is modeled by specifying the mass damping coefficient, α , and the stiffness damping coefficient, β , using the *DAMPING_PART_MASS and *DAMPING_PART_STIFFNESS cards, respectively. The mass damping coefficient is specified as a load curve, LCID, (LSTC, 2013) and a scale factor, SF. The ordinate of LCID denotes the time, namely, LCID stands for mass damping coefficient vs. time. Since no description of LCID was provided in the LS-DYNA manual, the ordinate of LCID was assumed to be the part number in the preliminary analysis. It was also found that the mass damping is not applied to nodal masses that are modeled using *ELEMENT_MASS, explaining the significantly larger spectral accelerations. Additionally, although unclear from the manual, it was found that the stiffness damping, β , should be specified as a negative number, in order to accurately model Rayleigh damping. The preliminary analysis was performed using a positive number for β , which simulates a different kind of stiffness damping that is different from the Rayleigh damping coefficient.
2. Mass distribution in beam type 2 (Belytschko-Schwer resultant beam): Most finite-element structural analysis programs use a lumped-mass matrix for beam elements that distribute the mass of the beam equally to the two beam nodes. This assumption was used to update the lumped masses in the preliminary model to compensate the non-zero beam material density. However, after performing some element-level analyses, it was found that the type 2 resultant beam also lumps the rotational inertia from the beam mass on to the nodes of the beam element, causing the change in the natural frequencies. Since the expression for this lumped rotational inertia is not known, a similar model cannot be created in CLASSI, making it almost impossible to maintain equivalence between the structural models. Facing this conundrum, it was decided that a very small density be used for the beam material (which reduced the rotational inertias to almost zero), along with the lumped masses used in CLASSI/SAP2000. In order to avoid the exceptionally large computation time, which is a consequence of the small density, the time step of the analysis was artificially increased to 10 times the critical time step. Given that this increase may result in numerical instabilities, each RHA is monitored by comparing the results with those calculated from CLASSI, and by examining the energy balance in the model.

The preliminary structural model in LS-DYNA was updated to counter the issues described above. Fixed-base analyses were also performed in SASSI for further verification. Results from the updated model are presented in Figure 2-3, which also includes the CLASSI and SASSI responses. The figure shows that the CLASSI, SASSI and updated LS-DYNA models result in very similar responses, hence proving the equivalence of the structural models.

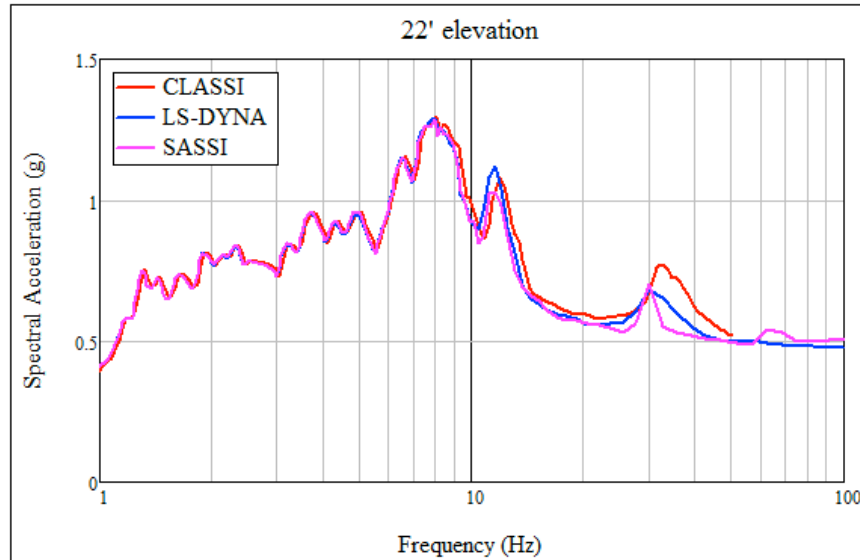

Figure 2-3: Spectral acceleration in the internal structure at 22ft elevation calculated using CLASSI, SASSI and the updated model in LS-DYNA

2.1.2.2 Results of fixed-base analyses

After verifying that the CLASSI and LS-DYNA models are equivalent, a fixed-base analysis is performed with the updated LS-DYNA model with simultaneous ground motion input in the X, Y and Z directions. The results of this analysis (spectral accelerations in the internal structure at 22ft and 61ft elevations) are presented in Figure 2-4. The figure includes the results calculated using 1) CLASSI, 2) updated LS-DYNA model with the default time step (referred to as ‘LS-DYNA’ in the legend), and 3) updated LS-DYNA model with scaled time step (referred to as ‘LS-DYNA tstep’ in the legend).

Figure 2-4 shows that the CLASSI and LS-DYNA responses are almost identical in the X and Y directions. Small differences exist between the responses in the Z direction, with LS-DYNA predicting smaller spectral accelerations at the higher frequencies. This might be due to the differences in the damping formulations: the CLASSI model uses a frequency-independent damping formulation, while the LS-DYNA model uses Rayleigh damping. The figure also shows that the results of the LS-DYNA analysis with a (10 times) scaled time step are identical to those calculated with the default time step. Therefore the scale factor of 10 for the time step is considered suitable for fixed-base analyses with other ground motion inputs.

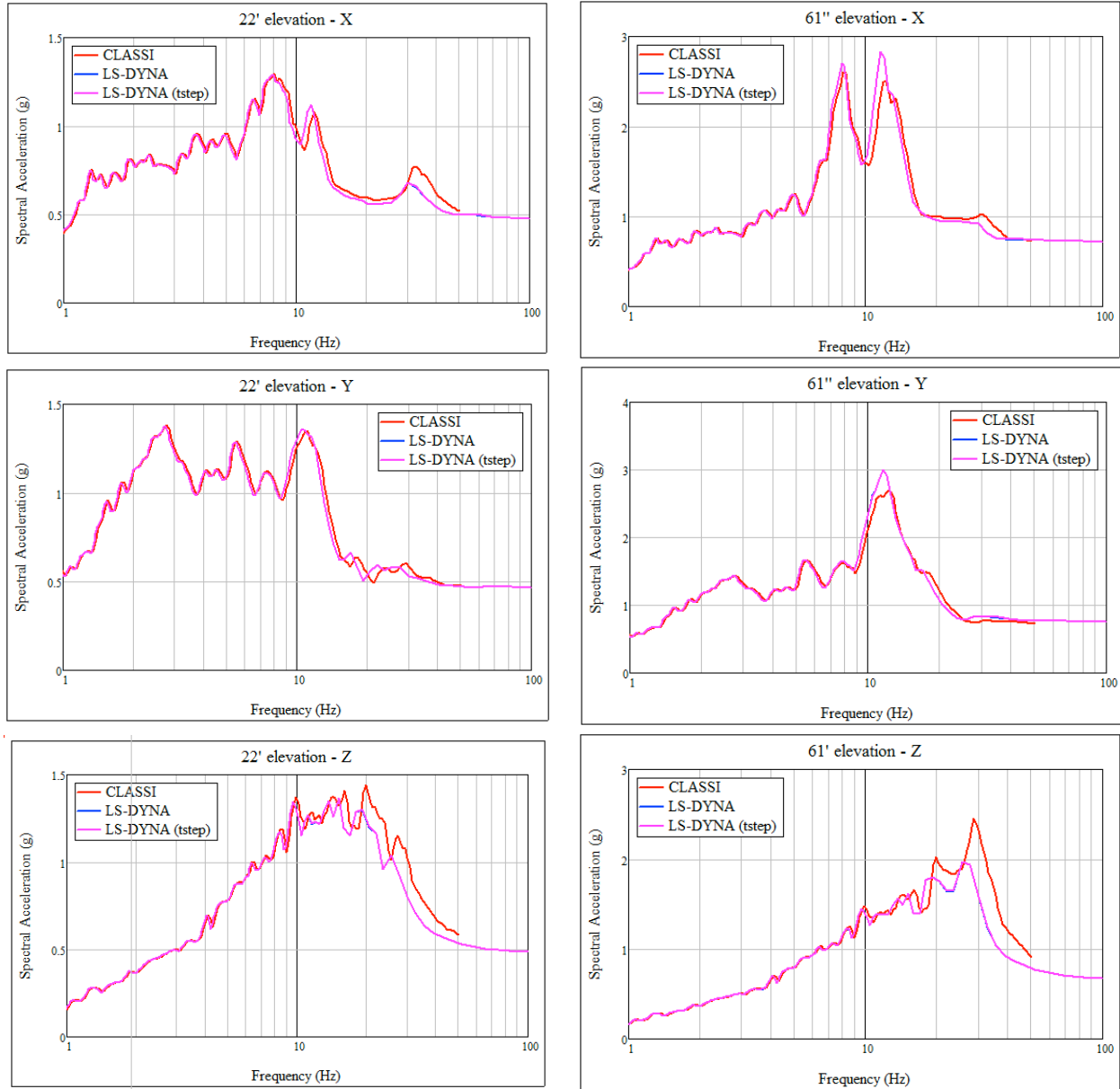

Figure 2-4: 5% damped spectral accelerations of the internal structure at 22ft elevation (left) and 61ft elevation (right)

2.2 Soil-structure interaction analysis

After verifying that the structural models in CLASSI and LS-DYNA are equivalent, SSI analyses are performed for the representative NPP structure in LS-DYNA. The NPP structure is supported by a surface basemat that is 10ft thick and 131ft in diameter. This basemat is assumed to be rigid and is modeled with the *MAT_RIGID material model in LS-DYNA. The soil domain is assumed to be a uniform halfspace with the soil properties listed in Table 2-2. The soil is assumed to be elastic and is modeled using the *MAT_ELASTIC material model. Prior to performing a nonlinear SSI analysis that simulates gapping and sliding at the foundation, a linear model is analyzed and the results are compared with CLASSI for verification. In this linear

model, the basemat is ‘tied’ to the soil surface, and no gapping or sliding is permitted. After the linear model is verified to produce the same response as CLASSI, it is modified to include contact models at the foundation-soil interface and the nonlinear analyses are performed. The procedure for SSI analysis in LS-DYNA is briefly described in the sections that follow. Results from linear analysis are presented in Section 2.2.2 and the results from nonlinear analyses are presented in Section 2.2.3.

Table 2-2: Soil properties

Property	Median	Lognormal Std. Deviation
Unit weight	159 lb/ft ³	-
Poisson’s ratio	0.35	-
Shear-wave velocity	3720 ft/sec	0.27
Shear modulus	68,320 kip/ft ²	0.55
Damping	2%	0.4

2.2.1 Modeling

Soil-structure interaction in a time domain code is performed using the direct method (Bolisetti and Whittaker, 2015; Spears and Coleman, 2014). In the direct method, the whole soil-structure system is analyzed in a single step thereby circumventing the use of superposition, which is extensively used in traditional SSI analysis methods (including SASSI and CLASSI) and is restricted to linear analyses. This enables a more realistic simulation with the use of nonlinear material models for the soil and structure, and contact models that simulate separation and sliding at the foundation-soil interface. Soil-structure interaction analysis using the direct method can be performed using most commercial finite-element codes such as ABAQUS (Dassault Systèmes, 2005), ANSYS (ANSYS Inc., 2013), LS-DYNA, or the open source finite-element code, OpenSees (Mazzoni *et al.*, 2009). Figure 2-5 presents a sample finite-element model for SSI analysis using the direct method in LS-DYNA.

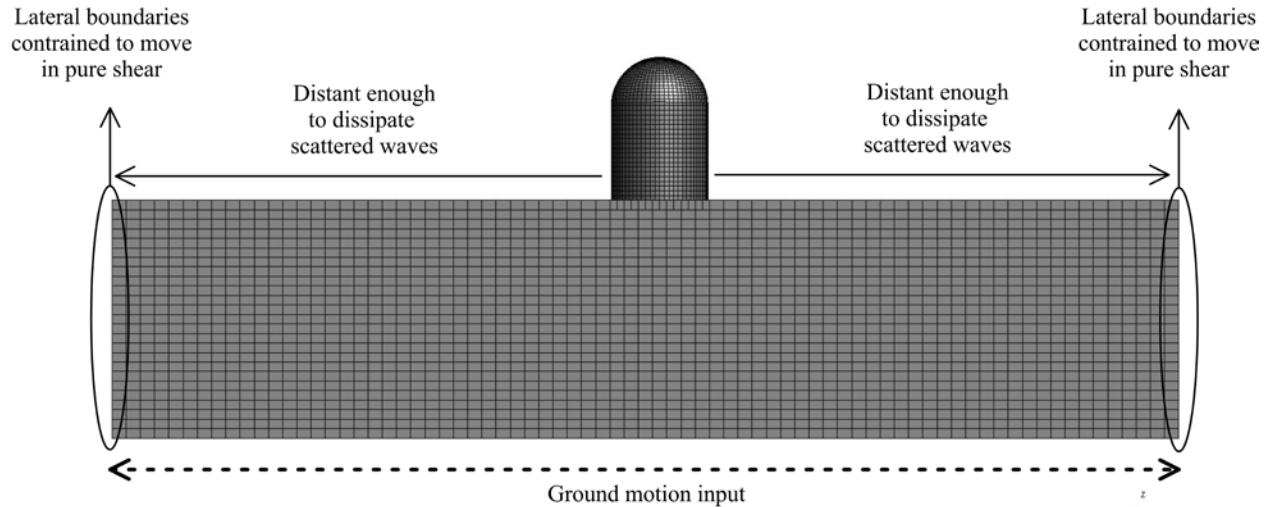

Figure 2-5: Description of a finite-element model for soil-structure interaction analysis using the direct method (Bolisetti *et al.*, 2015)

The finite domain in the direct method needs to satisfy the following conditions in order to simulate an infinite domain: 1) effective damping of the waves radiating away from the structure so that they do not reflect back into the soil domain from the lateral boundaries, and 2) stress equilibrium at the lateral boundaries to account for the rest of the soil domain that is not included in the finite domain model. The former is achieved by building a large soil domain with sufficient plan dimensions to dissipate the radiating waves before they reach the lateral boundaries. In this approach, the radiating waves are dissipated through hysteresis and viscous damping in the soil. The plan dimensions of the domain can be determined by a trial-and-error procedure, ensuring that the acceleration responses at the boundaries of the soil domain are equal to the free-field acceleration, which is calculated from a separate site-response analysis, and also by verifying that the structural response does not change with a further increase in the domain size. Stress equilibrium at the lateral boundaries can be obtained by constraining the boundary nodes at each elevation to move together in each direction. This enables the elements at the boundaries to move in pure shear, thus simulating a free-field condition (assuming that the input comprises vertically propagating shear waves), as shown in Figure 2-5.

The LS-DYNA numerical model for the SSI analysis of the representative NPP structure is presented in Figure 2-6. As illustrated in the figure, the soil domain of this model is 665ft \times 665ft in plan (about 5 times the size of the basemat, which is 131ft in diameter), and 214ft deep. The dimensions of the soil domain are chosen after trying two soil domain sizes. The chosen dimensions are verified by comparing the surface response at the edge of the soil domain to the free-field response from a separate one-dimensional site-response analysis. The soil domain is built with about 192,000 solid elements that have an almost uniform size of 8ft in all directions. This element size allows the propagation of frequencies up to about 40Hz, assuming 10 elements per wavelength. The base of the soil domain is modeled as a transmitting boundary using the *BOUNDARY_NON_REFLECTING option in LS-DYNA. The ground motion input in the CLASSI analysis is applied at the free field, which is not possible in the direct method. However given that soil domain is completely uniform, it can be assumed that the ground motion recorded at the free field is caused purely by the incident waves from the soil domain. These incident waves can be applied as an outcrop input to the LS-DYNA soil domain at any depth, in order to

achieve the same free-field ground motion as CLASSI. The outcrop input is applied as a shear force history as shown in Figure 2-7. This creates an incident wave that is reflected back into the soil domain at the surface. The dampers shown in Figure 2-7 absorb the reflected wave, simulating an infinite soil domain. To verify that the input excitation in CLASSI and LS-DYNA are equivalent, the free-field response from LS-DYNA (which is the surface response of the soil at the edge of the domain far from the structure) is compared with the free-field input in the CLASSI simulations. Figure 2-8 presents the spectral accelerations of the free-field input in CLASSI and the free-field response in LS-DYNA in X, Y and Z directions. The figure clearly shows that the responses are almost similar, except that the LS-DYNA response is slightly smaller in the higher frequencies. This can be attributed to 1) finite domain effects and 2) difference in the damping formulations in the two codes.

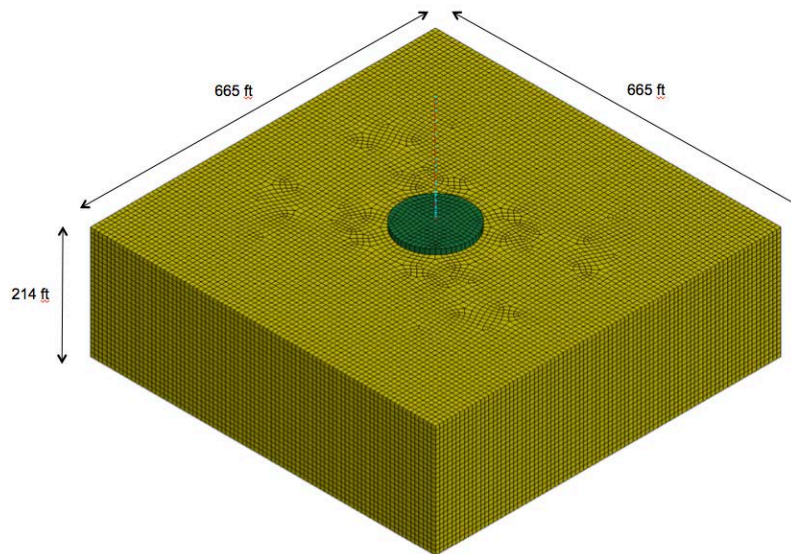

Figure 2-6: Finite-element model for the SSI analysis of the representative NPP structure

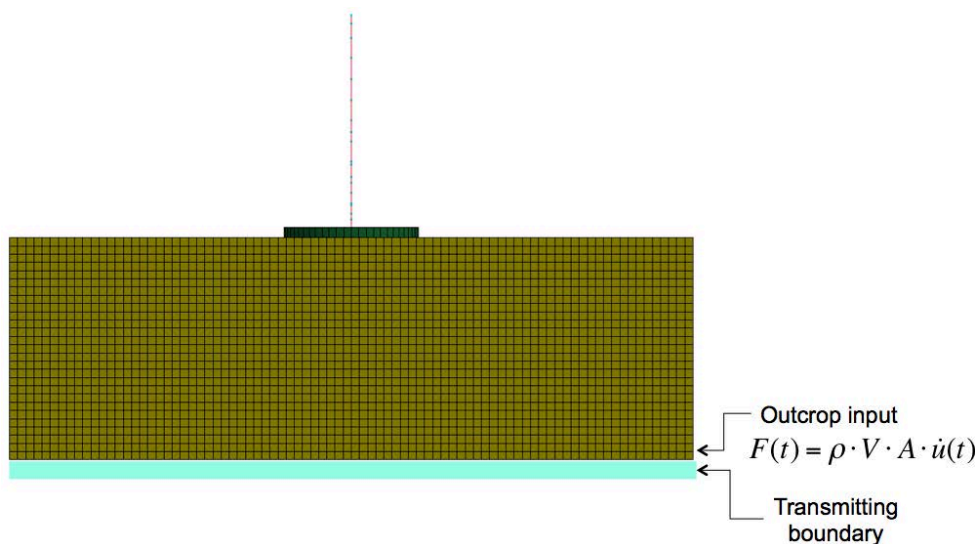

Figure 2-7: Procedure for ground motion input in the LS-DYNA model

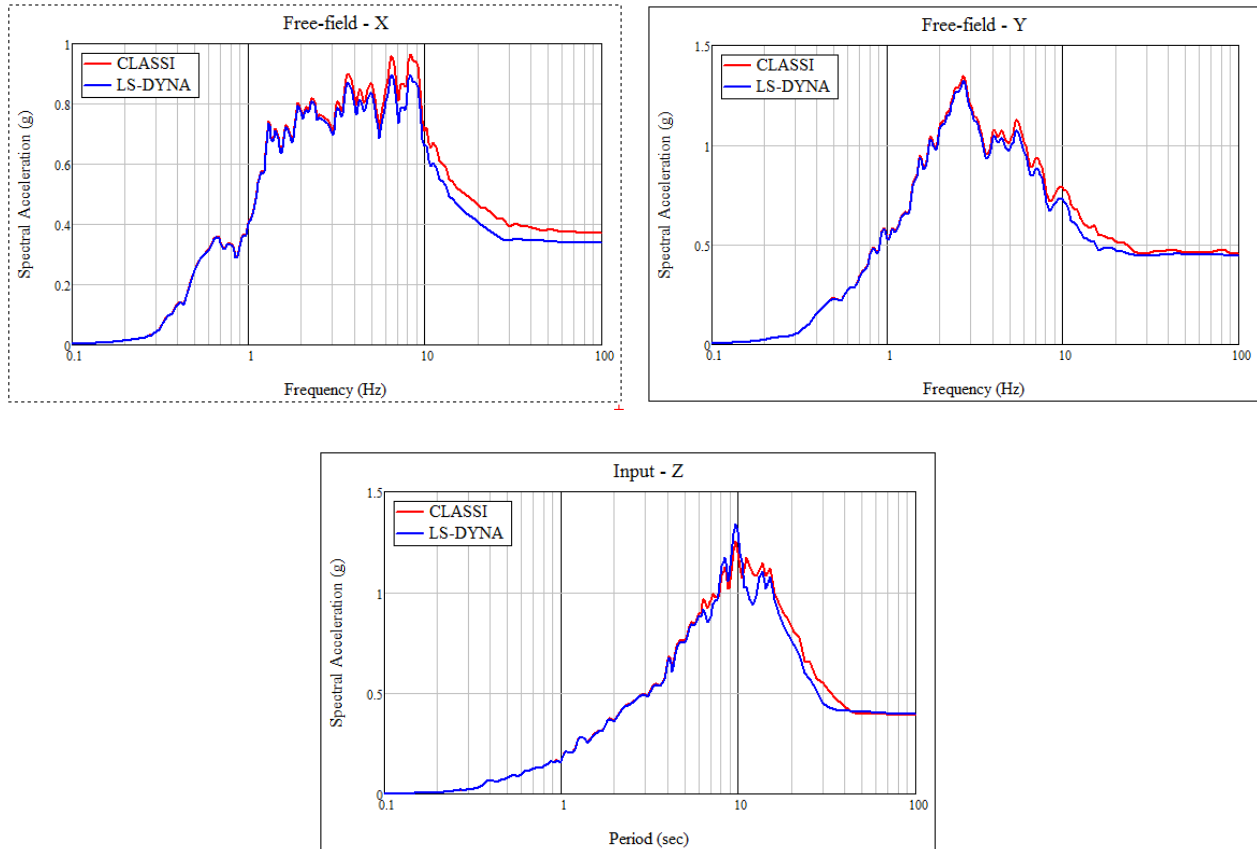

Figure 2-8: 5% damped response spectra of the free-field input acceleration in CLASSI and the free-field acceleration calculated using LS-DYNA

2.2.2 Linear analysis

A linear analysis, in which there is no separation at the foundation-soil interface, is performed in LS-DYNA to verify the SSI model by comparing the results to those calculated using CLASSI. Since CLASSI performs a linear analysis, there should be a very close match between the linear responses calculated using LS-DYNA and CLASSI. Following the procedure described in the previous section, a linear analysis is performed in LS-DYNA for one set (three directions) of ground motions. In this section results of this linear analysis are presented and compared with those from CLASSI.

In the linear analysis, the foundation is attached to the elastic soil using the *CONSTRAINED_EXTRA_NODES option, which constrains the basemat and soil nodes at the basemat-soil interface to move together. Figure 2-9 and Figure 2-10 present the CLASSI and LS-DYNA results for the linear analysis at the center of the basemat and the internal structure, respectively. The figures show that the linear analyses in CLASSI and LS-DYNA produce almost similar results. LS-DYNA results in slightly smaller spectral accelerations mainly because of the smaller free-field accelerations. Additionally, it should be noted that the SSI analysis procedure in CLASSI does not account for kinematic interaction, unlike LS-DYNA. The kinematic interaction in LS-DYNA can also contribute to the slight reduction in spectral accelerations, especially in the higher frequencies.

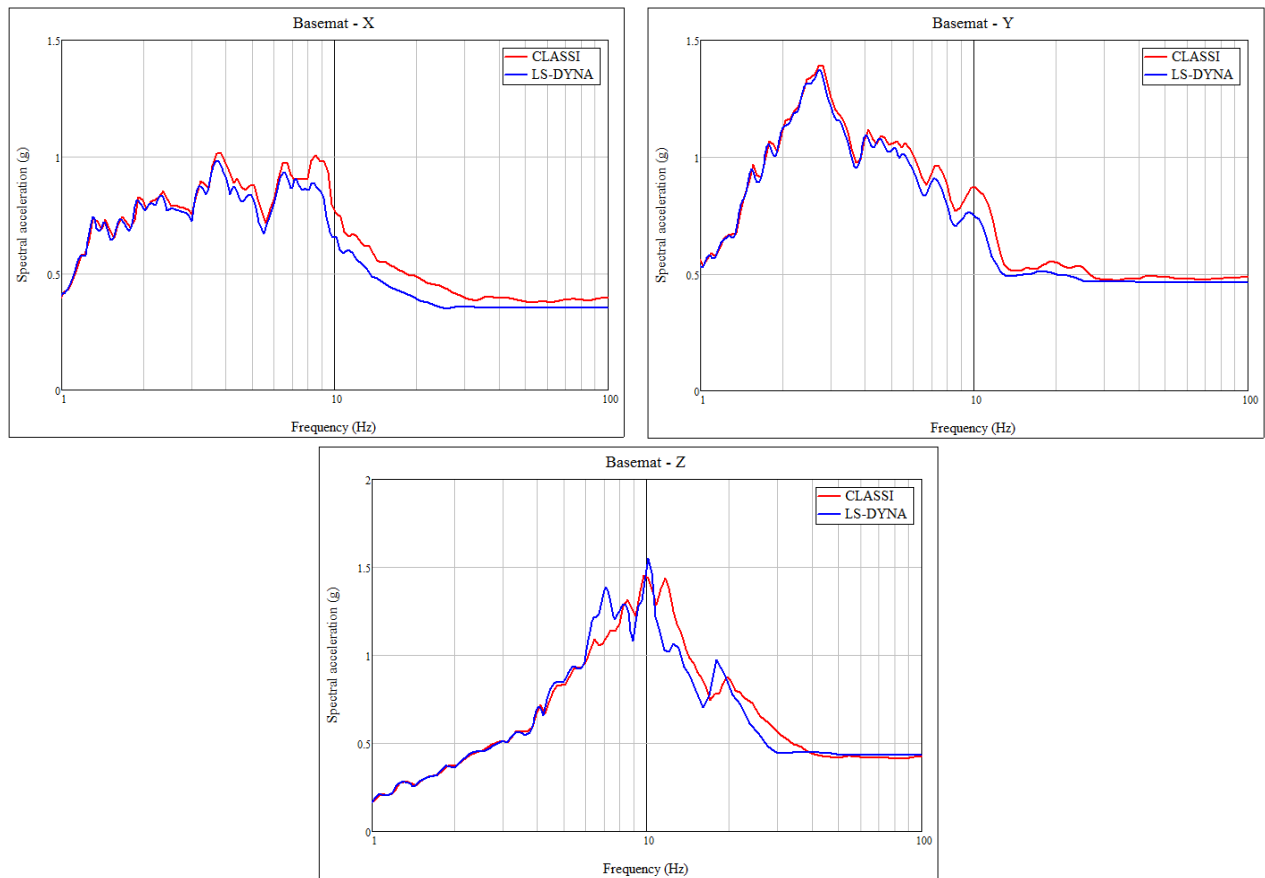

Figure 2-9: 5% damped acceleration response spectra on the basemat calculated using linear SSI analyses in CLASSI and LS-DYNA

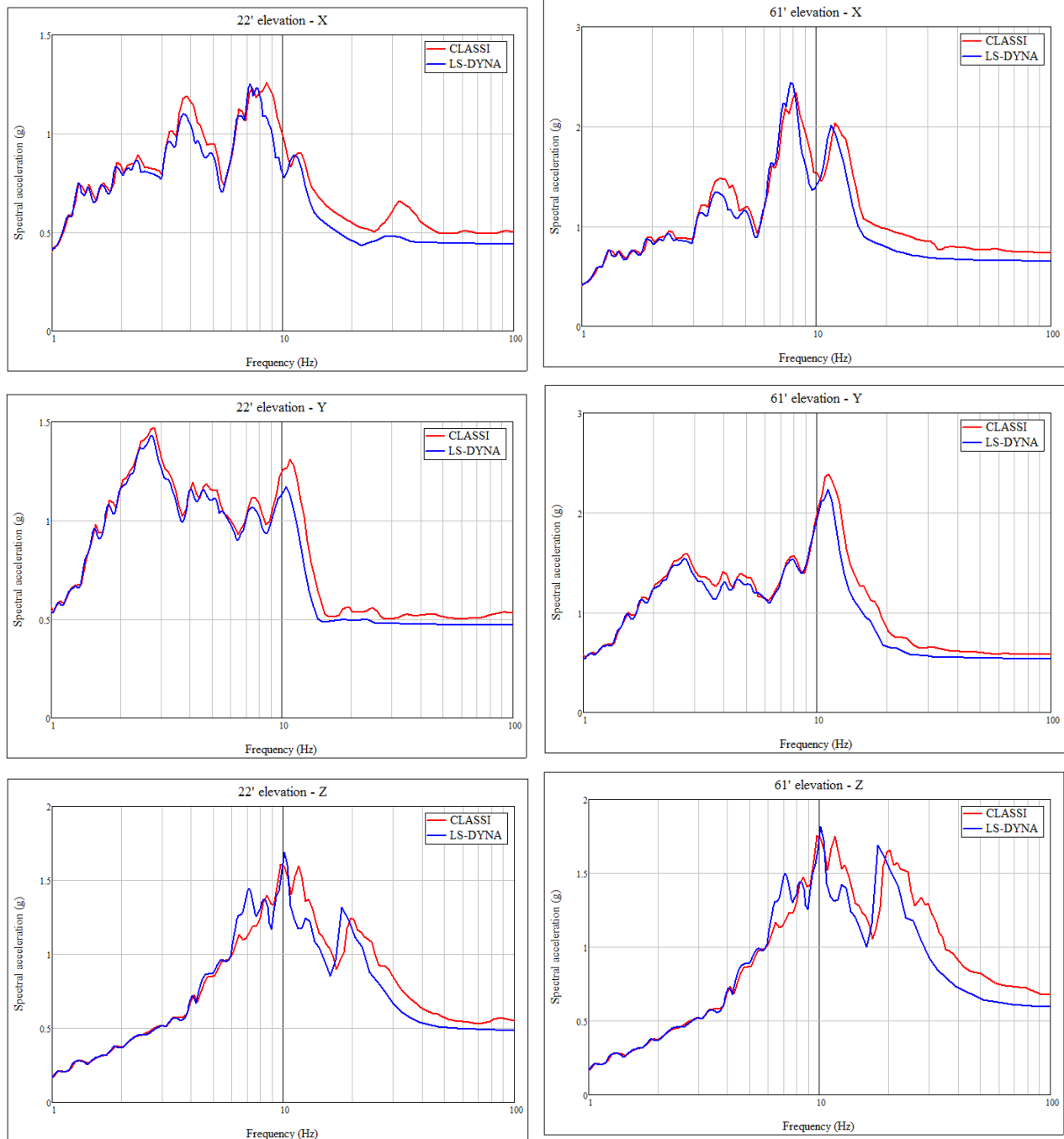

Figure 2-10: 5% damped acceleration response spectra in the internal structure at 22ft elevation (left) and 61ft elevation (right) calculated using linear SSI analyses in CLASSI and LS-DYNA

2.2.3 Nonlinear analysis

Nonlinear response in SSI analyses is a result of 1) nonlinear site response, which affects the foundation-level input motion to the structure, 2) hysteretic response of the soil at the vicinity of the foundation, which results in foundation flexibility and hysteretic energy dissipation at the foundation and 3) gapping and sliding of the foundation. The study presented in this report

focuses on geometric nonlinearities at the foundation, namely, gapping and sliding. Accordingly, some preliminary analyses were performed to simulate gapping and sliding of the rigid foundation on elastic soil halfspace. These analyses showed unrealistic amplifications in the structural response. These amplifications are due to the absence of nonlinear hysteretic behavior of the foundation, which can only be captured through nonlinear soil modeling at the foundation vicinity. Therefore, to make the problem more realistic, nonlinear analyses of this section are performed while also accounting for the hysteretic response of the soil at the vicinity of the foundation. Nonlinear analyses of this section are performed for two cases: 1) including hysteretic soil response at the foundation vicinity and ignoring gapping and sliding (foundation and soil are 'tied' together), and 2) including hysteretic soil response at the foundation vicinity as well as considering gapping and sliding. *Note that, since all the analyses of this section are exploratory and are used to establish an appropriate procedure to model the basemat-soil contact, they are performed using rigid material model for the superstructure unlike in linear analyses. Using rigid properties for the superstructure significantly increases the time step resulting in much shorter computation times. However, the analyses performed as a part of SPRA calculations will use actual properties of the superstructure.*

Figure 2-11 presents a section view of the nonlinear SSI model. As illustrated in the figure, nonlinear soil (indicated in brown) is used at the vicinity of the basemat. The shear modulus, mass density and Poisson's ratio used for the elastic soil (see Table 2-2) are also used for the nonlinear soil. This soil is modeled using the *MAT_HYSTERETIC material model in LS-DYNA. Figure 2-12 presents the backbone curve used to model the nonlinear soil. The 'tied' basemat-soil contact is modeled using *CONSTRAINED_EXTRA_NODES, similar to linear analyses. The contact for nonlinear analyses including geometric nonlinearities is modeled using the *CONTACT_AUTOMATIC_SURFACE_TO_SURFACE model, which simulates both separation and sliding at the contact interface. A value of 0.7 is used for the both the static and dynamic friction coefficients, and a contact damping of 50% is used to reduce numerical noise from the usage of contact models.

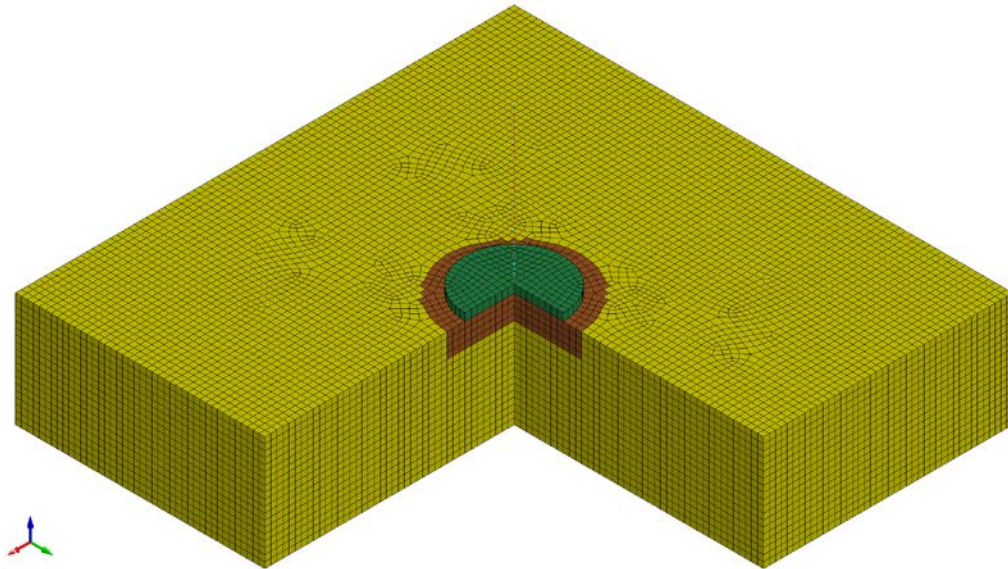

Figure 2-11: Section view of the nonlinear model illustrating the nonlinear soil (brown), linear soil (yellow) and basemat (green)

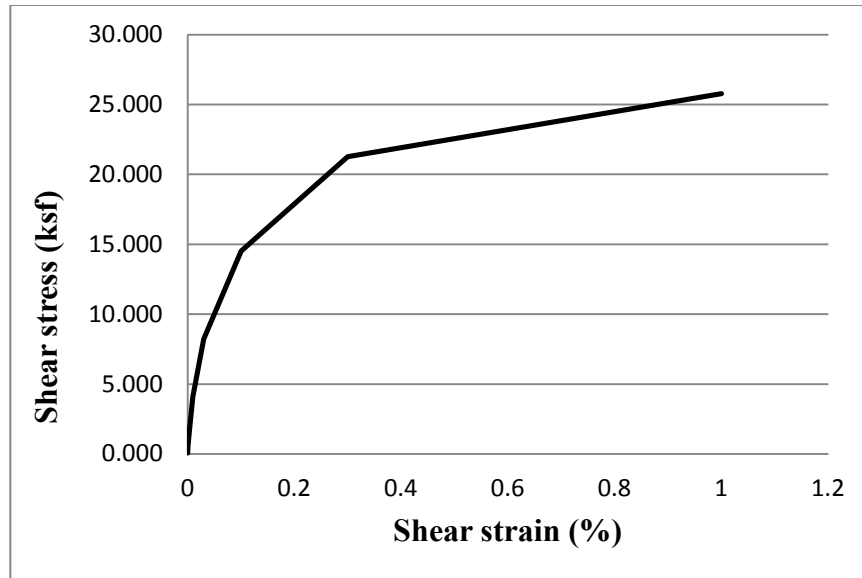

Figure 2-12: Backbone curve used in the nonlinear soil around the foundation in the nonlinear LS-DYNA analyses

Figure 2-13 presents the response spectra at the center of the basemat for 1) linear analysis using LS-DYNA (referred to as LS-DYNA L), 2) nonlinear analyses with hysteretic soil response at the basemat vicinity but no gapping or sliding (referred to as LS-DYNA NL), and 3) nonlinear analyses with hysteretic soil response at basemat vicinity as well as gapping and sliding (referred to as ‘LS-DYNA NL GS’). Figure 2-14 in-structure response spectra the 22 ft and 61 ft elevations for these analyses.

The figures show significant differences between the linear and nonlinear analyses. Specifically, the peak spectral accelerations occur at a smaller frequency that in the linear analyses, indicating increased foundation flexibility in the X and Y directions. However the nonlinear analyses result in slightly larger peak spectral accelerations in the Z direction.

Introducing gapping and sliding in the nonlinear analyses results in meaningful changes in the spectral responses. However these changes are small compared with those resulting from introducing nonlinear hysteretic soil response. Additionally, gapping and sliding result in a small increase in the spectral acceleration in the X and Z directions and a small decrease in the Y direction, indicating that the effect of geometric nonlinearities on the response is case-dependent.

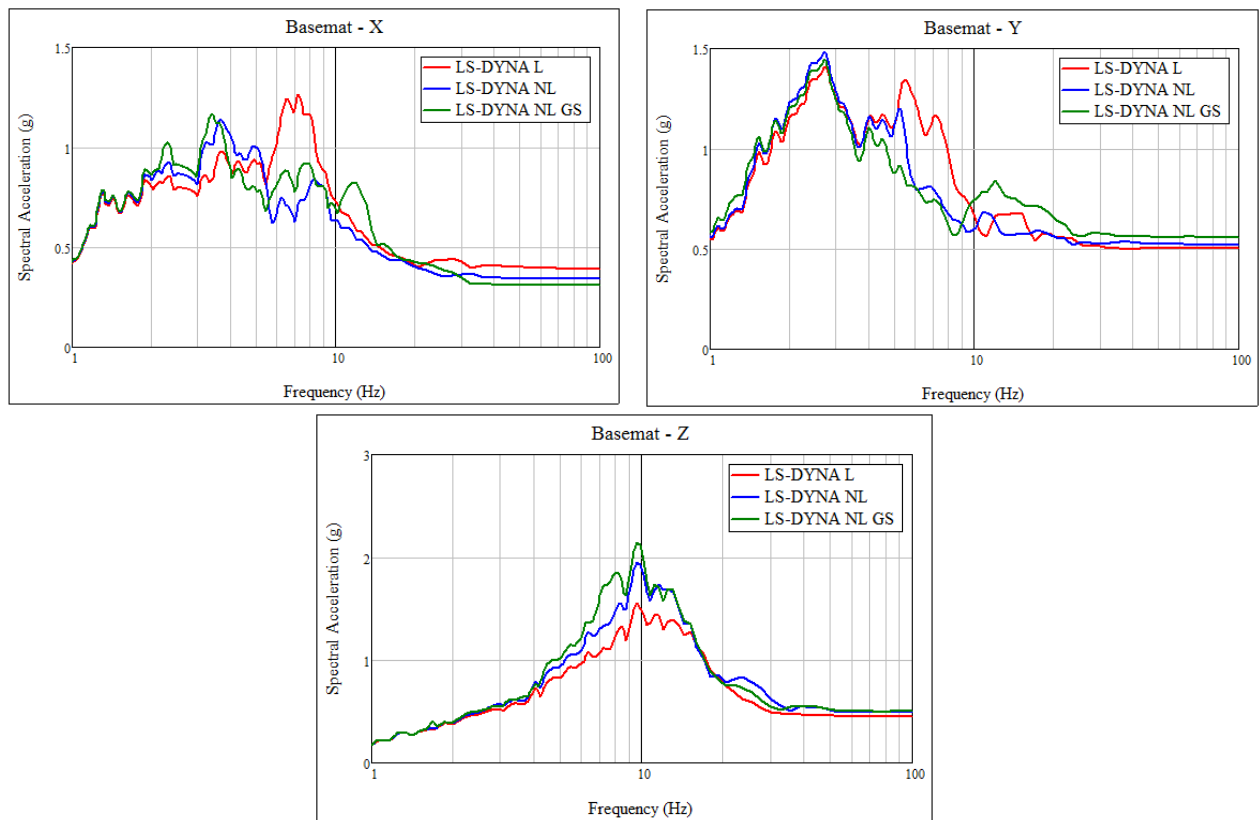

Figure 2-13: 5% damped acceleration response spectra on the basemat calculated using nonlinear analyses in LS-DYNA

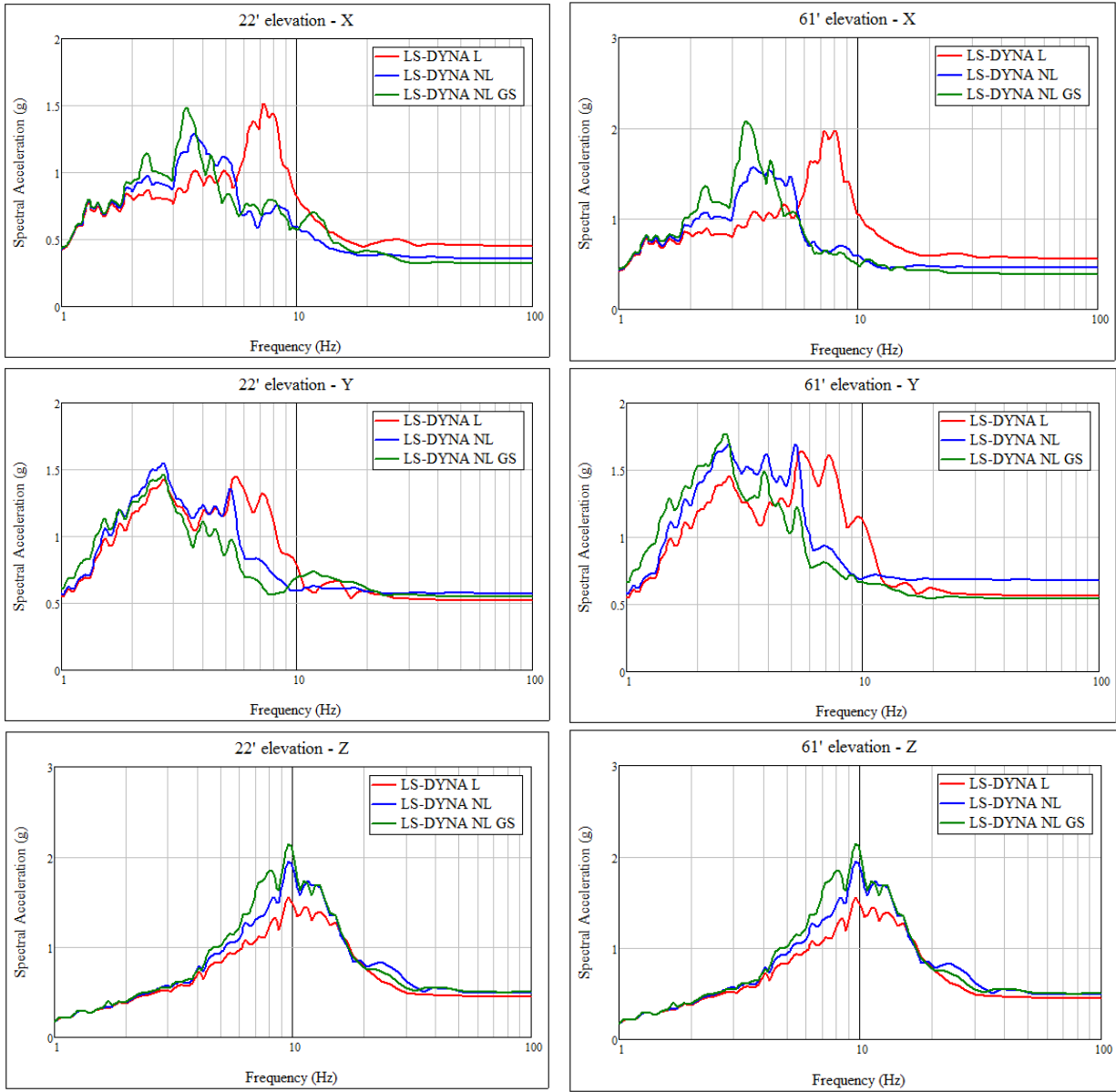

Figure 2-14: 5% damped acceleration response spectra in the internal structure at 22ft elevation (left) and 61ft elevation (right) calculated using nonlinear SSI analyses LS-DYNA

3. Conclusions

This report presents the development of a methodology of nonlinear SSI analysis for implementation in advanced seismic probabilistic risk assessment. Linear analyses are first performed in the time domain using LS-DYNA and the results are compared to those calculated using the frequency-domain code, CLASSI. After identifying and resolving some practical issues with structural modeling in LS-DYNA, the time-domain results match reasonably well with those calculated in the frequency domain.

After benchmarking the linear time-domain models in LS-DYNA against the frequency-domain models, the LS-DYNA models are extended to incorporate nonlinear effects due to 1) local soil nonlinearities due to the hysteretic behavior of the soil at the vicinity of the foundation, and 2) gapping and sliding. Results from nonlinear analyses show significant deviations from the linear results, mainly from local soil nonlinearities at the foundation. Gapping and sliding also introduce considerable changes in the in-structure response. However these changes are smaller than those introduced by local soil nonlinearities. Additionally the deviation of the nonlinear responses from the corresponding linear results shows that the in-structure response does not scale linearly with increasing ground motion.

In conclusion, a functional NLSSI model has been developed that includes 1) local soil nonlinearities at the foundation and 2) geometric nonlinearities. This NLSSI model will be run multiple times at increasing levels of ground motion to generate in-structure response spectra that will be input into the advanced SPRA calculations. Comparison of traditional SPRA and advanced SPRA results will be provided in the September 30th deliverable.

4. References

- Bathe, K.-J. (1996). "Finite Element Procedures." Prentice Hall, Upper Saddle River, New Jersey.
- Bolisetti, C., and Whittaker, A. S. (2015). "Site Response, Soil-Structure Interaction and Structure-Soil-Structure Interaction for Performance Assessment of Buildings and Nuclear Structures." MCEER-15-0002, Multidisciplinary Center for Earthquake Engineering Research (MCEER), University at Buffalo, The State University of New York, Buffalo, NY.
- Bolisetti, C., Whittaker, A. S., and Coleman, J. L. (2015). "Frequency- and Time-Domain Methods in Soil-Structure Interaction Analysis." *Nuclear Engineering and Design*, Under Review.
- Coleman, J. (2014), "Demonstration of NonLinear Seismic Soil Structure Interaction and Applicability to New System Fragility Seismic Curves," INL/EXT-14-33222, Idaho National Laboratory, Idaho Falls, Idaho.
- Computers and Structures Inc. (2011). Computer Program: SAP2000 - Structural Analysis Program, Version 11.0.0. Computers and Structures, Inc., Berkeley, California.
- Livermore Software Technology Corporation (LSTC). (2009). "LS-DYNA Theory Manual." Livermore, California.
- Livermore Software Technology Corporation (LSTC). (2013). "LS-DYNA Keyword User's Manual - Version R 7.0." Livermore, California.
- Lysmer, J., Ostadan, F., and Chin, C. (1999). Computer Program: SASSI2000 - A System for Analysis of Soil-Structure Interaction. University of California, Berkeley, California.
- Ostadan, F. (2006). "SASSI2000: A System for Analysis of Soil Structure Interaction - User's Manual." University of California, Berkeley, California.
- Spears, R., and Coleman, J. (2014). "Nonlinear Time Domain Soil-Structure Interaction Methodology Development." INL/EXT-14-33126, Idaho National Laboratory, Idaho Falls, Idaho.
- Willford, M., Sturt, R., Huang, Y., Almufti, I., and Duan, X. (2010). "Recent Advances in Nonlinear Soil-Structure Interaction Analysis using LS-DYNA." *Proceedings of the NEA-SSI Workshop*, October 6-8, Ottawa, Canada.