

## Impact of CO<sub>2</sub> on the Evolution of Microbial Communities Exposed to Carbon Storage Conditions, Enhanced Oil Recovery, and CO<sub>2</sub> Leakage

20 June 2016

## Disclaimer

This report was prepared as an account of work sponsored by an agency of the United States Government. Neither the United States Government nor any agency thereof, nor any of their employees, makes any warranty, express or implied, or assumes any legal liability or responsibility for the accuracy, completeness, or usefulness of any information, apparatus, product, or process disclosed, or represents that its use would not infringe privately owned rights. Reference therein to any specific commercial product, process, or service by trade name, trademark, manufacturer, or otherwise does not necessarily constitute or imply its endorsement, recommendation, or favoring by the United States Government or any agency thereof. The views and opinions of authors expressed therein do not necessarily state or reflect those of the United States Government or any agency thereof.

**Cover Illustration:** Overview of a) heterogeneous flow of injected CO<sub>2</sub> into a potential saline aquifer and oil reservoir as storage units, b) a potential leakage scenario into shallow formations, and c) the expected gradients of aqueous carbon dioxide (CO<sub>2(aq)</sub>) and pH following injection and leakage.

**Suggested Citation:** Gulliver, D. M.; Gregory, K. B.; Lowry, G. V. *Impact of CO<sub>2</sub> on the Evolution of Microbial Communities Exposed to Carbon Storage Conditions, Enhanced Oil Recovery, and CO<sub>2</sub> Leakage*; NETL-TRS-7-2016; NETL Technical Report Series; U.S. Department of Energy, National Energy Technology Laboratory: Pittsburgh, PA, 2016; p 64.

**An electronic version of this report can be found at:**

<http://netl.doe.gov/research/on-site-research/publications/featured-technical-reports>

<https://edx.netl.doe.gov/carbonstorage>

**Impact of CO<sub>2</sub> on the Evolution of Microbial Communities Exposed to  
Carbon Storage Conditions, Enhanced Oil Recovery, and CO<sub>2</sub> Leakage**

**Djuna M. Gulliver<sup>1</sup>, Kelvin B. Gregory<sup>2</sup>, Gregory V. Lowry<sup>2</sup>**

**<sup>1</sup> U.S. Department of Energy, National Energy Technology Laboratory, 626 Cochrans Mill  
Road, Pittsburgh, PA 15236**

**<sup>2</sup> Department of Civil and Environmental Engineering, Carnegie Mellon University, 5000  
Forbes Avenue, Pittsburgh, PA 15213**

---

**NETL-TRS-7-2016**

20 June 2016

NETL Contacts:

Djuna Gulliver, Principal Investigator

Angela Goodman, Technical Portfolio Lead

Cynthia Powell, Executive Director, Research and Innovation Center

This page intentionally left blank.

# Table of Contents

<b>ABSTRACT</b> .....	<b>1</b>
<b>1. INTRODUCTION</b> .....	<b>2</b>
1.1 INTRODUCTION.....	2
1.2 PROBLEM IDENTIFICATION.....	2
1.3 RESEARCH OBJECTIVES AND PROJECT STRUCTURE.....	3
<b>2. METHODS</b> .....	<b>5</b>
2.1 SITE BACKGROUND.....	5
2.2 PRESSURIZED VESSEL EXPOSURE EXPERIMENTS.....	5
2.3 MICROBIAL COMMUNITY ANALYSIS.....	6
2.4 CHEMICAL ANALYSIS (GAS AND LIQUID).....	8
2.5 WATER CHEMISTRY MODEL.....	8
<b>3. OBSERVATIONS</b> .....	<b>9</b>
3.1 IMPACT OF CO <sub>2</sub> ON THE EVOLUTION OF MICROBIAL COMMUNITIES FROM THE ARBUCKLE SALINE AQUIFER.....	9
3.2 IMPACT OF CO <sub>2</sub> ON THE EVOLUTION OF MICROBIAL COMMUNITIES FROM THE MIRANDO OIL RESERVOIR.....	16
3.3 IMPACT OF CO <sub>2</sub> ON THE EVOLUTION OF MICROBIAL COMMUNITIES FROM THE PLANT DANIEL FRESHWATER AQUIFER.....	21
3.4 COMPARISON OF IMPACT OF CO <sub>2</sub> ON THE EVOLUTION OF MICROBIAL COMMUNITIES.....	29
3.5 FAILED EXPERIMENTS.....	34
<b>4. CONCLUSIONS</b> .....	<b>39</b>
4.1 CONCLUSIONS AND CONTRIBUTIONS.....	39
4.2 IMPLICATIONS.....	39
4.3 FUTURE WORK.....	40
<b>5. REFERENCES</b> .....	<b>42</b>
<b>APPENDIX A: SUPPLEMENTARY FIGURES</b> .....	<b>A-1</b>
<b>APPENDIX B: SUPPLEMENTARY TABLES</b> .....	<b>B-1</b>

This page intentionally left blank.

## List of Figures

Figure 1: Concentration of 16S rRNA gene copies recovered from reactors exposing unfiltered saline aquifer samples to increasing pCO <sub>2</sub> as revealed by qPCR for 0 days, 1 day, 7 days, and 56 days of exposure.....	10
Figure 2: Relative proportions of phylotypes recovered from reactors exposing unfiltered saline aquifer samples to increasing pCO <sub>2</sub> as revealed by 16S rRNA gene clone libraries and qPCR for a) initial drill stem test sample, and following b) 1 day of exposure, c) 7 days of exposure, and d) 56 days of exposure.....	11
Figure 3: Impact of exposure time and pCO <sub>2</sub> on microbial diversity of unfiltered saline aquifer samples.....	12
Figure 4: Microbial ecology characterized by 16S rRNA gene clone libraries and microbial population quantified by qPCR methods for 7 day and 56 day exposures to 1.4 MPa pCO <sub>2</sub> or the equivalent pH-only adjustment to 4.4.....	15
Figure 5: Impact of pCO <sub>2</sub> versus pH-only on microbial diversity of unfiltered saline aquifer samples.....	15
Figure 6: Relative proportions of phylotypes recovered from reactors exposing unfiltered produced water samples to increasing pCO <sub>2</sub> as revealed by 16S rRNA gene clone libraries and qPCR for a) initial produced fluid sample, and following b) 56 days of exposure to different pCO <sub>2</sub> values.....	17
Figure 7: Impact of 56 days of pCO <sub>2</sub> exposure on microbial diversity of unfiltered produced water samples.....	18
Figure 8: Relative proportions of phylotypes recovered from reactors exposing unfiltered produced water samples to increasing pCO <sub>2</sub> revealed by 16S rRNA gene clone libraries and qPCR for 56 day exposures to 0.34 MPa pCO <sub>2</sub> or 0.34 MPa pCO <sub>2</sub> with CaCO <sub>3</sub> buffer.....	20
Figure 9: Relative proportions of phylotypes recovered from reactors exposing unfiltered freshwater aquifer samples to increasing pCO <sub>2</sub> as revealed by 16S rRNA gene clone libraries and qPCR for a) initial drill stem test sample, and following b) 56 days of exposure.....	22
Figure 10: Impact of exposure time and pCO <sub>2</sub> on microbial diversity of unfiltered freshwater aquifer samples.....	23
Figure 11: Microbial ecology characterized by 16S rRNA gene clone libraries and microbial population quantified by qPCR methods for 56 day exposures to 0.05 MPa pCO <sub>2</sub> or 0.05 MPa pCO <sub>2</sub> with CaCO <sub>3</sub> buffer.....	25
Figure 12: Relative proportions of phylotypes recovered from unfiltered well samples downgradient of CO <sub>2</sub> -saturated-water injection well.....	26
Figure 13: Impact of dissolved CO <sub>2</sub> on microbial diversity of unfiltered freshwater aquifer samples downgradient of CO <sub>2</sub> -saturated-water injection.....	27
Figure 14: Comparison of 16S rRNA gene clone libraries and 454 pyrosequencing of relative proportions of phylotypes recovered from unfiltered well samples downgradient of CO <sub>2</sub> -saturated-water injection well.....	28
Figure 15: DNA concentration of the Plant Daniel freshwater aquifer, the Mirando depleted oil reservoir, and the Arbuckle saline aquifer versus 0–14 MPa pCO <sub>2</sub> .....	29
Figure 16: DNA concentration of the Plant Daniel freshwater aquifer, the Mirando depleted oil reservoir, and the Arbuckle saline aquifer measured by qPCR for modeled pH.....	30

## List of Figures (cont.)

Figure 17: Unifrac plot of sequences recovered from vessel experiments with Plant Daniel freshwater aquifer sample, Mirando oil reservoir sample, and Arbuckle saline aquifer sample. ....	31
Figure 18: Community tree calculated by Yue and Clayton theta diversity index of sequences recovered from vessel experiments with Plant Daniel freshwater aquifer sample, Mirando oil reservoir sample, and Arbuckle saline aquifer sample. ....	32
Figure 19: Dendrogram of distance matrix calculated for the geochemistry of each sample utilizing the canberra equation. ....	33
Figure 20: Relative proportions of phylotypes recovered from core sediment material from the Cranfield saline aquifer as revealed by 16S rRNA gene clone libraries. ....	34
Figure 21: Relative proportions of phylotypes recovered from reactors exposing unfiltered Mississippi oil reservoir samples to increasing pCO <sub>2</sub> as revealed by 16S rRNA gene clone libraries for initial drill stem test sample, and following 56 days of exposure. ....	35
Figure 22: Relative proportions of phylotypes recovered from reactors exposing unfiltered Plant Daniel freshwater aquifer samples to increasing pCO <sub>2</sub> as revealed by 16S rRNA gene clone libraries and qPCR for a) initial drill stem test sample, and following b) 1 day of exposure, c) 7 days of exposure, and d) 56 days of exposure. ....	38



## Acronyms, Abbreviations, and Symbols

Term	Description
BSA	Bovine serum albumin
CCS	Carbon capture and storage
CO <sub>2</sub>	Carbon dioxide
CO <sub>2(aq)</sub>	Aqueous carbon dioxide
DOE	U.S. Department of Energy
EOR	Enhanced oil recovery
EPA	U.S. Environmental Protection Agency
EPRI	Energy Power Research Institute
GCS	Geologic carbon storage
IEA	International Energy Administration
LNBL	Lawrence Berkeley National Laboratory
NETL	National Energy Technology Laboratory
OTU	Operational taxonomic unit
PCR	Polymerase chain reaction
qPCR	Quantitative polymerase chain reaction
SC-CO <sub>2</sub>	Super critical carbon dioxide
TOC	Total organic carbon

## Acknowledgments

This work was completed as part of National Energy Technology Laboratory (NETL) research for the U.S. Department of Energy's (DOE) Complementary Research Program under Section 999 of the Energy Policy Act of 2005. The author wishes to acknowledge Cindy Powell and Karl Schroeder (NETL Office of Research and Development) as well as Angela Goodman (NETL Technical Portfolio Manager Carbon Storage) for guidance, direction, and support.

The authors also wish to acknowledge Aimee Scheffer, Dr. Jennifer Roberts, and Dr. David Fowle from the University of Kansas. The authors would also like to acknowledge Dr. Charuleka Varadharajan of Lawrence Berkeley National Laboratory (LBNL) and John Pugh of Southern Company Services, and the petroleum scientists at the Mirando oil reservoir.

## **ABSTRACT**

Geologic carbon storage (GCS) is a crucial part of a proposed mitigation strategy to reduce the anthropogenic carbon dioxide (CO<sub>2</sub>) emissions to the atmosphere. During this process, CO<sub>2</sub> is injected as super critical carbon dioxide (SC-CO<sub>2</sub>) in confined deep subsurface storage units, such as saline aquifers and depleted oil reservoirs. The deposition of vast amounts of CO<sub>2</sub> in subsurface geologic formations could unintentionally lead to CO<sub>2</sub> leakage into overlying freshwater aquifers. Introduction of CO<sub>2</sub> into these subsurface environments will greatly increase the CO<sub>2</sub> concentration and will create CO<sub>2</sub> concentration gradients that drive changes in the microbial communities present. While it is expected that altered microbial communities will impact the biogeochemistry of the subsurface, there is no information available on how CO<sub>2</sub> gradients will impact these communities.

The overarching goal of this project is to understand how CO<sub>2</sub> exposure will impact subsurface microbial communities at temperatures and pressures that are relevant to GCS and CO<sub>2</sub> leakage scenarios. To meet this goal, unfiltered, aqueous samples from a deep saline aquifer, a depleted oil reservoir, and a fresh water aquifer were exposed to varied concentrations of CO<sub>2</sub> at reservoir pressure and temperature. The microbial ecology of the samples was examined using molecular, DNA-based techniques. The results from these studies were also compared across the sites to determine any existing trends.

Results reveal that increasing CO<sub>2</sub> leads to decreased DNA concentrations regardless of the site, suggesting that microbial processes will be significantly hindered or absent nearest the CO<sub>2</sub> injection/leakage plume where CO<sub>2</sub> concentrations are highest. At CO<sub>2</sub> exposures expected downgradient from the CO<sub>2</sub> plume, selected microorganisms emerged as dominant in the CO<sub>2</sub> exposed conditions. Results suggest that the altered microbial community was site specific and highly dependent on pH. The site-dependent results suggest a limited ability to predict the emerging dominant species for other CO<sub>2</sub> exposed environments.

This study improves the understanding of how a subsurface microbial community may respond to conditions expected from GCS and CO<sub>2</sub> leakage. This is the first step for understanding how a CO<sub>2</sub>-altered microbial community may impact injectivity, permanence of stored CO<sub>2</sub>, and subsurface water quality. Future work with microbial communities from new subsurface sites would increase the current understanding of this project. Additionally, incorporation of metagenomic methods would increase understanding of potential microbial processes that may be prevalent in CO<sub>2</sub> exposed environments.

## 1. INTRODUCTION

### 1.1 INTRODUCTION

Carbon capture and storage (CCS) is likely to be part of a comprehensive solution to reduce carbon dioxide (CO<sub>2</sub>) emissions from fossil energy combustion. Atmospheric CO<sub>2</sub> concentrations continue to rise (Rackley, 2009), increasing the risk of more frequent extreme weather events (Meehl et al., 2000). The International Energy Administration (IEA) predicts that to reduce this risk by 2050, 8.2 gigatonne CO<sub>2</sub>/yr will need to be captured for carbon storage (IEA, 2011).

Geologic carbon storage (GCS) is the end process of CCS. After capture of CO<sub>2</sub> from fossil fuel burning for industrial or municipal power production, CO<sub>2</sub> is injected into deep subsurface rock formations, termed geologic storage units, for long-term sequestration from the surface environment. Geologic storage units that have been targeted for future sequestration include both brine aquifers and oil reservoirs. Optimizing the storage capacity of the formations is an important goal of GCS scientists and engineers. In addition, the CO<sub>2</sub> storage deposits should be permanent, with little risk of release to the overlying environments. Overlying environments at risk include shallow potable aquifers and the surface environment. The storage capacity and permanence of CO<sub>2</sub> deposits will be impacted by a variety of geophysical, geochemical, and biogeochemical processes. This project focuses on the microbiology that will drive the biogeochemical processes.

### 1.2 PROBLEM IDENTIFICATION

Geochemical parameters, such as salinity, dissolved metal concentration, and pH determine the microbial community that adapts to thrive in the subsurface. Although these microorganisms are capable of inhabiting a wide range of environmental conditions, there remain some limits to microbial survival in extreme conditions. For example, many microorganisms do not survive in environments with temperature above 110°C, pH below 0.7, pH above 11, or salinity above 30% NaCl (Madigan et al., 2008). Nonetheless, a diverse microbial community is known to thrive in the deep geologic subsurface (Amend and Teske, 2005).

The microorganisms that thrive in the deep subsurface drive biogeochemical reactions that impact the fate of carbon and other minerals and nutrients in those environments (Arrigo, 2005). Microorganisms may affect the reservoir capacity to store CO<sub>2</sub> and the permanence of stored CO<sub>2</sub> through biomineralization of CO<sub>2</sub> (Rivadeneira et al., 2006; Sanchez-Roman et al., 2007), biofilm formation that alters flow and storage (Bin et al., 2008; Cunningham et al., 2009; Satpute et al., 2010), dissolution of carbonate minerals through acid production (Bin et al., 2008; Park et al., 2009; Warscheid and Braams, 2000), and dissolution of minerals through metal mobility (Gadd, 2004). These microbial processes are known to have a large impact on the geochemistry and geology in the deep subsurface and are therefore likely to affect the fate of CO<sub>2</sub> throughout GCS. Therefore, microbial populations that adapt to CO<sub>2</sub> exposure are likely to play a vital role in carbon storage. In order to understand the biogeochemical reactions that will affect CO<sub>2</sub> storage, the microbial populations that will thrive in these systems must first be identified.

While bacteria are likely to have a large impact on reservoir capacity and CO<sub>2</sub> security over the lifetime of geological carbon storage, no information is available about the microbial populations that will survive and/or thrive following exposure to CO<sub>2</sub> at temperatures and pressures that are relevant to storage conditions. *The overarching goal of the research is to understand the*

*microbial communities and populations that are likely to arise in the subsurface throughout GCS.*

### **1.3 RESEARCH OBJECTIVES AND PROJECT STRUCTURE**

This project aims to understand changes in subsurface microbial communities following exposure to aqueous carbon dioxide (CO<sub>2(aq)</sub>) at concentrations expected during CO<sub>2</sub> storage. Since GCS is most likely to begin in saline aquifers and depleted oil reservoirs, the research will address the microbial community changes in these critical deep subsurface environments. In addition, this project aims to understand changes in subsurface microbial communities following exposure to CO<sub>2(aq)</sub> at concentrations expected should CO<sub>2</sub> leak from the deep subsurface into overlying shallow, freshwater environments.

The goal of this project will be met through achieving three main objectives. These objectives are to: 1) define the microbial community changes and populations that arise following CO<sub>2</sub> exposure under GCS conditions on subsurface samples from carbon storage environments (saline aquifers and depleted oil reservoirs); 2) define the microbial community changes and populations that arise following a leakage scenario of CO<sub>2</sub> into a freshwater environment; and 3) determine if changes in the microbial communities and populations that arise in these environments are similar or vary among the subsurface sites. These objectives are met through completing the following the tasks:

*Task 1: Measure the impact of CO<sub>2</sub> on the evolution of microbial communities from saline aquifer samples*

Task 1 aims to understand the microbial community response to increasing CO<sub>2(aq)</sub> concentrations that would be expected following heterogeneous flow of injected CO<sub>2</sub> in a saline aquifer. Relevant microbial communities are examined in fluid samples and suspended solids from the proposed carbon storage site, the Arbuckle Aquifer. The changes in the microbial community are examined under pCO<sub>2</sub> exposure of 0%, 1%, 10%, and 100% under site pressure and temperature for up to 56 days. Population cell numbers are quantified by quantitative polymerase chain reaction (qPCR), and microbial population characterized by clone libraries.

*Task 2: Measure the impact of CO<sub>2</sub> on the evolution of microbial communities from depleted oil reservoir samples*

Task 2 aims to understand the microbial community response to increasing CO<sub>2(aq)</sub> concentrations that would be expected following heterogeneous flow of injected CO<sub>2</sub> in depleted oil reservoirs. Relevant microbial communities are examined in fluid samples and suspended solids from the proposed carbon storage site, the Mirando Oil Field. The changes in the microbial community are examined under pCO<sub>2</sub> exposure of 0%, 1%, 10%, and 100% under site pressure and temperature for 56 days. Population cell numbers are quantified by qPCR, and microbial population characterized by clone libraries.

*Task 3: Measure the impact of CO<sub>2</sub> on the evolution of microbial communities from fresh water aquifer samples*

Task 3 aims to understand the microbial community response to increasing CO<sub>2(aq)</sub> concentrations that would be a result of CO<sub>2</sub> leakage into a freshwater aquifer. Relevant microbial communities for Task 3 are examined from fluid samples of the Plant Daniel fresh water aquifer. The Plant Daniel Aquifer has been flooded with dissolved CO<sub>2</sub> to represent a

leakage scenario. Samples are collected both up-gradient and down-gradient of the CO<sub>2</sub> injection. The changes in the microbial community of the up-gradient samples are examined under pCO<sub>2</sub> exposure of 0%, 1%, 10%, and 100% under site pressure and temperature for up to 56 days. Population cell numbers are quantified by qPCR, and microbial population characterized by clone libraries and by pyrosequencing.

*Task 4: Compare the impact of CO<sub>2</sub> on the evolution of microbial communities among all of the samples examined*

Task 4 determines if microbial community changes are similar with CO<sub>2</sub> exposure, regardless of initial conditions, or if microbial community changes with CO<sub>2</sub> exposure vary amongst the initial conditions in different subsurface sites. The structure of each microbial community is directly compared between the three sites, and the extent of community differences and similarities is visualized using a UniFrac plot and a community tree. In addition, trends in cell numbers with increasing pCO<sub>2</sub> exposure amongst the different communities are discussed.

This work uses difficult to obtain samples of water and solids from the subsurface. The microbial community from each sample is exposed to increasing pCO<sub>2</sub> under the temperature and pressure of the subsurface site, in order to best simulate conditions and geochemistry expected to occur after CO<sub>2</sub> injection or CO<sub>2</sub> leakage. The high pressure was required in order to maintain supercritical conditions for CO<sub>2</sub> in the vessels. It is the first study to examine the initial (~2 months) response of a subsurface microbial community to different CO<sub>2(aq)</sub> concentrations that may be expected following GCS or a super critical carbon dioxide (SC-CO<sub>2</sub>) leak.

This project begins to fill in knowledge gaps in subsurface microbial community response to CO<sub>2</sub> storage. The subsurface often contains up to 10<sup>7</sup> cell/mL (Parkes et al., 1994), and may consist of thousands of species; it is a laborious task to study all the microbial processes of this diverse system. However, this project hypothesized that the microbial community that adapts to CO<sub>2</sub> exposure will be a smaller population and less diverse. The microbial processes of relevance will be from this community of reduced diversity. This project serves to identify the adapted microbial communities from carbon storage environments at relevant formation temperature and pressures. The project may guide future studies on biogeochemical processes of the most relevant species expected to survive and thrive in a formation following CO<sub>2</sub> exposure. Identifying the microbial communities that are selected for by CO<sub>2</sub> exposure will help to identify the types of bioprocesses that may play a role in long-term carbon storage.

## **2. METHODS**

### **2.1 SITE BACKGROUND**

The Arbuckle saline aquifer (about 1,220- to 1,460-m depth) is part of the Ozark Plateau aquifer system, in Sumner County, Kansas. The aquifer has not yet been injected with CO<sub>2</sub>, but has been estimated by the Kansas Geologic Survey to have a CO<sub>2</sub> sequestration capacity of 1.1 to 3.8 billion metric tonnes. The aquifer consists of mostly dolomite containing lenses of shale, and has a reservoir pressure of 14 MPa and a reservoir temperature of 40°C. Well 1-32 (latitude 37.3154639, longitude 97.4423481), in the Arbuckle formation, was drilled in January of 2011. Formation samples were obtained during the drill stem test after 4,800 L of purging. The samples had less than 0.5 g/L suspended solids.

The Mirando oil field, Zapata County, Texas, is part of the Eocene formation, 490 m to 610 m depth, consisting of fine grained marshal sand. Average reservoir pressure is 3.4 MPa, and average reservoir temperature is 40°C. This reservoir has not yet been injected with CO<sub>2</sub>, and currently produces about 10 barrels of oil per day. A fluid slurry sample was withdrawn from Chargos Creek Well A (latitude 27.1506936, longitude 98.9972297) from the pump jack at the end of a routine oil draw to maximize the formation water sampled and minimize any contamination from drilling. The samples had an 8–10% oil water cut, and had less than 0.5 g/L suspended solids.

A detailed site description of the Plant Daniel freshwater aquifer is given in in Trautz et al. (2013). Briefly, the Plant Daniel freshwater aquifer is an Energy Power Research Institute (EPRI) site used for investigating the geochemical and geophysical changes that can be expected in a freshwater aquifer from CO<sub>2</sub> leakage from an underlying GCS site (Trautz et al., 2013; Dafflon et al., 2013). The freshwater aquifer is located in Escatawpa, Mississippi, and consists of sandy units with semi-confining clay-rich units and is about 55 m in depth and 6 m in thickness. The reservoir temperature is 22°C, and reservoir pressure 0.5 MPa. Samples were drawn after utilizing the U.S. Environmental Protection Agency (EPA) low purge sampling protocol. Samples had less than 0.5 g/L suspended solids.

Additionally, for the Plant Daniel site, exposure of the microbial community to CO<sub>2</sub> in situ was performed by pressurizing extracted groundwater with 0.35 MPa CO<sub>2</sub> (pH=5) and then reinjecting the CO<sub>2</sub>-water mixture into the aquifer. The groundwater was otherwise untreated. Two months after injection, three monitoring wells downgradient of the injection, TW1, TW2, and MW3, and one background well upgradient of the injection, BG1, were sampled for formation fluid. Samples were drawn after utilizing the EPA low purge sampling protocol. Dissolved CO<sub>2</sub> concentration of each sample was measured at each monitoring well using a dissolved gas meter (CarboQC, Anton Paar). A detailed description of CO<sub>2</sub> injection and sampling locations and methods is given in Trautz et al. (2013).

### **2.2 PRESSURIZED VESSEL EXPOSURE EXPERIMENTS**

Arbuckle saline aquifer and Mirando oil field formation samples were exposed to CO<sub>2</sub> in 1-L, Teflon-lined stainless steel static pressure vessels; details of these vessels can be found in Kutcho et al. (2007). A volume of 200 mL of reservoir water was added to each vessel. ISCO syringe pumps pressurized vessels with pure CO<sub>2</sub> gas first to achieve the desired pCO<sub>2</sub> and 99.5% N<sub>2</sub>/0.5% H<sub>2</sub> gas second to maintain a fixed total pressure of 14 MPa for the Arbuckle vessels, and 3.4 MPa for the Mirando vessels. The experimental pCO<sub>2</sub> of the Arbuckle vessels

was 0, 0.1, 1.4, and 14 MPa and of the Mirando vessels was 0, 0.03, 0.34, and 3.4 MPa, which represented 0%, 1%, 10%, and 100% of the total pressure respectively. All reactors were maintained at a constant temperature of 40°C. Sampling was performed by sacrificing vessels after 56 days of exposure to CO<sub>2</sub>.

Identical vessel reactors were studied using the Arbuckle sample, 1M HCl, and no addition of CO<sub>2</sub>, in order to understand the effect of a reduced pH on the microbial community. The pH examined in this control vessel was 4.4, the value that resulted from exposure to 1.4 MPa CO<sub>2</sub>. The pH-only vessel was pressurized with 99.5% N<sub>2</sub>/0.5% H<sub>2</sub> gas to 14 MPa and was maintained at 40°C; sampling was performed by sacrificing vessel after 56 days of exposure to CO<sub>2</sub>. The pH of the sacrificing vessel was measured to be 5.1 in the depressurized vessel at the end of the experiment.

An additional vessel was pressurized with 200 mL Mirando sample, 0.34 MPa pCO<sub>2</sub>, and 10 g/L CaCO<sub>3</sub>, in order to understand the impact of pH buffering by reservoir solid. The vessel was maintained at a constant 40°C temperature and 3.4 MPa total pressure, and sampling was performed by sacrificing vessel after 56 days.

Unfiltered fluid samples from the Plant Daniel freshwater aquifer were placed in 150 mL Swagelok vessels rated for 14 MPa. The 80 mL of Plant Daniel sample from well BG-1 was pressurized to 0.5 MPa using either 100% N<sub>2</sub>, 1% CO<sub>2</sub>/99% N<sub>2</sub>, 10% CO<sub>2</sub>/90% N<sub>2</sub>, or 100% CO<sub>2</sub>. In addition, in order to understand the effect of buffering on the aquifer system, a separate vessel was pressurized for 56 days with 80 mL formation fluid, 10 g/L CaCO<sub>3</sub> and pressurized with 10% CO<sub>2</sub>/90% N<sub>2</sub> gas. The vessels were stored at room temperature, which closely resembles aquifer temperature. Sampling occurred after 56 days.

After sampling, the fluid was centrifuged at 4,000 g for 25 min. The top 75 mL of the supernatant was filtered for chemical analysis, and the bottom 5 mL of the fluid containing solids was used for the microbial community analysis described below.

### 2.3 MICROBIAL COMMUNITY ANALYSIS

DNA was extracted from 500 µl of the remaining 5 mL of the centrifuged utilizing a modified method described previously in Holmes et al. (2004) for the Arbuckle samples (Gulliver et al., 2014), and the MoBio power soil kit for the Mirando and Plant Daniel samples. Polymerase chain reaction (PCR) amplification followed shortly using universal bacteria and archaea primers. The bacteria 16S rRNA gene fragments were amplified using the 8 forward primer 5'-AGAGTTTGATCMTGGCTCAG-3' (Lane et al., 1985) with the 519 reverse primer 5'-GTATTACCGCGGCTGCTGG-3' (Lane et al., 1985) and the 338 forward primer 5'-ACTCCTACGGGAGGCAGC-3' (Amann et al., 1995) with the 907 reverse primer 5'-CCGTC AATTCMTTTRAGTTT-3' (Lane, 1991). The archaeal 16S rRNA fragments were amplified using the 344 forward primer 5'-ACGGGGCGCAGCAGGCGCGA-3' (Raskin et al., 1994) with the 915 reverse primer 5'-GTGCTCCCCCGCCAATTCCT-3' (DeLong, 1992). Each primer set was run in a PCR mixture with a total volume of 20 µl containing Qiagen Q-solution, 10x buffer, MgCl, and bovine serum albumin (BSA) along with the DNA template. The thermocycler was run with a taq initiation step at 95°C for 3 min, followed by 35 cycles of a denaturing step of 94°C for 1 min, an annealing step at 47°C for 45 sec, and an elongation step at 72°C for 45 sec. After the 30 cycles, a final extension occurred at 72°C for 7 min. Efficacy of the PCR reaction was tested via electrophoresis gel, using *E. coli* DNA as a positive bacteria control



and *Methanococcus maripaudis* as a positive archaea control. No Archaea was detected in the initial sample or the vessel samples. No further analysis of Archaea was performed.

For samples that did not amplify with this method, nested PCR was additionally used, first using the 8 forward primer 5'-AGAGTTTGATCMTGGCTCAG-3' with the 1114 reverse primer 5'-GGGTTGCGCTCGTTGC-3' (Reysenbach and Pace, 1995), followed by the amplification using the 338 forward primer 5'-ACTCCTACGGGAGGCAGC-3' with the 907 reverse primer 5'-CCGTCAATTCMTTTRAGTTT-3'. The thermocycler procedure was identical to the single PCR amplification method, but with 30 cycles followed by 35 cycles. Between the amplifications, the Qiagen clean-up kit was utilized.

The PCR products of the two bacterial primer sets were mixed, and cloned using the Invitrogen TOPO TA cloning kit according to the manufacturer's instructions. 96 clones per Mirando and EPRI sample and 48 clones per Arbuckle sample were sequenced at Functional Biosciences (Madison, WI).

To increase the microbial coverage captured by sequencing, 454 pyrosequencing was performed on the Mirando samples and the Plant Daniel samples. The universal primer 515 forward primer 5'-GTGCCAGAMGCCGCGTAA-3' was used with the roche adapter A-CCATCTCATCCCTGCGTCTCTCGACTCAG and coupled with the 806 reverse primer 5'-GGACTACVSGGGTATCTAAT-3' and the roche adapter B-CCTATCCCCTGTGTGCCTTGGCAGTCTCAG (Bates et al., 2011). Each primer set was run in a PCR mixture with a total volume of 50 µl containing Qiagen HotStart Taq along with the DNA template. The thermocycler was run with a taq initiation step at 94°C for 10 min, followed by 30 cycles of a denaturing step of 94°C for 1 min, an annealing step at 55°C for 1 min, and an elongation step at 72°C for 1 min. After the 30 cycles, a final extension occurred at 72°C for 10 min. Efficacy of the pyrosequencing reaction was tested via electrophoresis gel, using *E. coli* DNA as a positive control. The reactions were sent to the Ohio State University genomics facility for pyrosequencing.

16s rRNA clone library sequences were trimmed using FinchTV, and pyrosequencing was trimmed using Mothur (Schloss et al., 2009). Chimeras were detected using Bellophon (Huber et al., 2004) for the 16S rRNA clone library sequences and Uchime for the pyrosequencing sequences (Edgar et al., 2011). Sequences with 97% similarity were grouped into operational taxonomic units (OTU) on the genus level using Mothur and NCBI Blast (Schloss et al., 2009; Altschul et al., 1990). In cases where OTUs are less than 97% similar to a phylotype of a cultured organism, the microorganisms are described as "other".

Bacteria 16S rRNA gene concentration were determined by qPCR, using the 1369 forward primer 5'-CGGTGAATACGTTTCYCGG-3' with the 1492 reverse primer 5'-GGWTACCTTGTTACGACTT-3' and the TAMRA 6 FAM 1389 forward probe CTTGTACACACCGCCCGTC (Suzuki et al., 2000). The PCR mixture consisted of a total volume of 20 µl containing Applied Biosystems TaqMan Master mix along with the primers, probe, and DNA template. Diluted samples of known concentrations of *E. coli* were used as bacteria standards. The *E. coli* was quantified with pico green procedures described in Invitrogen Quanti-iT kit. The DNA was amplified using an initiation step at 50°C for 2 min and denaturing of 95°C for 10 min, followed by 40 cycles of 95°C for 15 sec and 56°C for 1 min.

In order to determine the microbial diversity represented in each clone library, sequences were grouped into phylotypes based on 16S rRNA gene similarity of > 97%. Diversity was

represented by equitability (J), which was calculated from Shannon-Weaver indices. Equitability was calculated at the species-level for each sample using the equation  $J=H/H_{\max}$ , where  $H_{\max}$  is the maximum Shannon-Weaver index and H is the sample Shannon-Weaver index. Shannon-Weaver indices were calculated using the equation  $-\sum[(n_i/N) \ln (n_i/N)]$ , where N is the total number of phylotypes and  $n_i$  is the number of “i” phylotypes.<sup>15</sup>

## 2.4 CHEMICAL ANALYSIS (GAS AND LIQUID)

To determine if gas production or consumption was occurring, Arbuckle and Mirando samples from the pressure vessels were analyzed for H<sub>2</sub>, CO<sub>2</sub>, CH<sub>4</sub>, O<sub>2</sub>, and N<sub>2</sub> using a gas chromatograph (PerkinElmer Clarus 600) immediately after sampling. Gases were separated by a 0.125-in. diameter Carboxin column, 15 m in length, and 60/80 μm particle size. The oven was programmed to begin at 36°C and ramp at 20°C/min to 225°C and hold for 1.3 min. No gases other than CO<sub>2</sub> and N<sub>2</sub> were detected, and GC data was used as a method of ensuring the desired pCO<sub>2</sub> was maintained and no unwanted oxygen had leaked into the reactors.

Supernatant sample water was filtered through a 0.2 μm filter before any chemical analysis. Sample water was analyzed for selected elements (Ca, Fe, K, Mg, Mn, Na, P, S, Si, Zn) by ICP-OES (PerkinElmer Optima 7300 DV) using EPA method 6010C. Supernatant anions (Cl, NO<sub>3</sub>, NO<sub>2</sub>, PO<sub>4</sub>, SO<sub>4</sub>, Br) were also analyzed via a Dionex Ion Chromatograph using EPA method 300.1. Chemical components that were non-detect for all samples are not reported. Total organic carbon was measured in 10 mL triplicate volumes via 1010 Total Organic Carbon Analyzer. Alkalinity was measured by titration of 30 mL volumes with sulfuric acid to a pH of 4.5.

## 2.5 WATER CHEMISTRY MODEL

Since pH could not be directly measured in the pressurized reactors, it was estimated using Geochemist Workbench. The initial system was defined using the measured alkalinity and pH of the initial water. In addition, cation concentrations above 10<sup>-2</sup> M (from the ICP-OES data) were used to define the initial system, with chloride as a counter ion to ensure electroneutrality. Conversion of pCO<sub>2</sub> to moles of CO<sub>2</sub> reacted in each system was calculated from the real gas law using the pCO<sub>2</sub>, the remaining 800 mL vessel volume, and site temperature. The gas compressibility factor was assumed to be 1 for all reactors except the 100% pCO<sub>2</sub> Arbuckle vessel and the 100% pCO<sub>2</sub> Mirando vessel. These vessels were calculated to have a compressibility factor of 0.27 and 0.83 respectively.

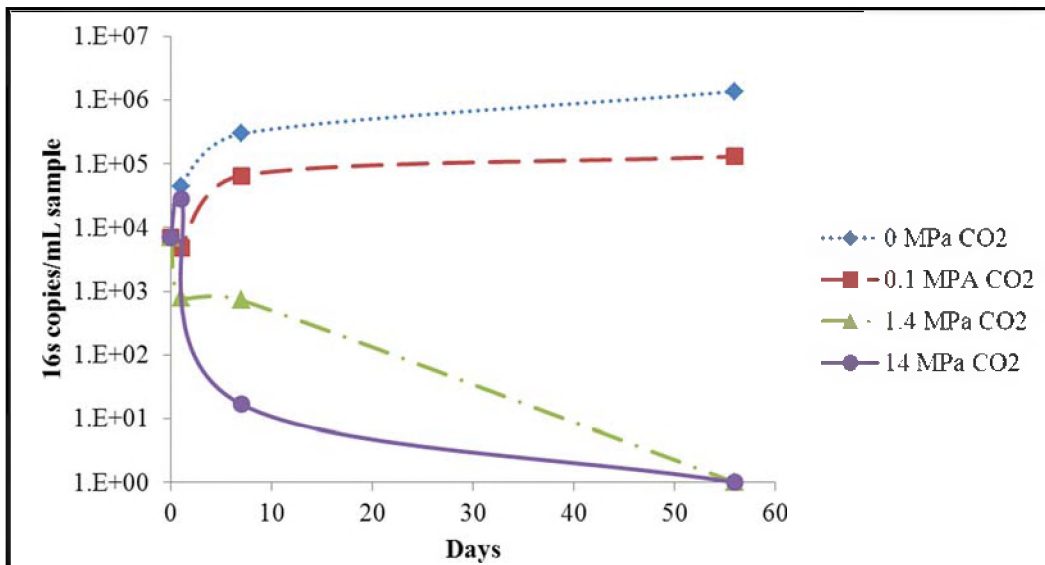
In order to compare the geochemistry of each sample, a distance matrix was calculated with R utilizing the Canberra equation (Team, 2008). Parameters used to calculate the distance matrix were site temperature, total pressure, alkalinity, pH, and concentrations of selected geochemistry (Ca, Fe, K, Mg, Mn, Na, P, Cl, SO<sub>4</sub>, Br). An additional distance matrix was created for the OTU shared file also utilizing the Canberra equation. The geochemistry distance matrix and the OTU distance matrix were then compared with the Mantel equation to calculate a correlation coefficient. The Mantel equation was also used to compare the Unifrac distance matrix with the geochemistry distance matrix, but this correlation coefficient was not found to be significant (>0.1).

### **3. OBSERVATIONS**

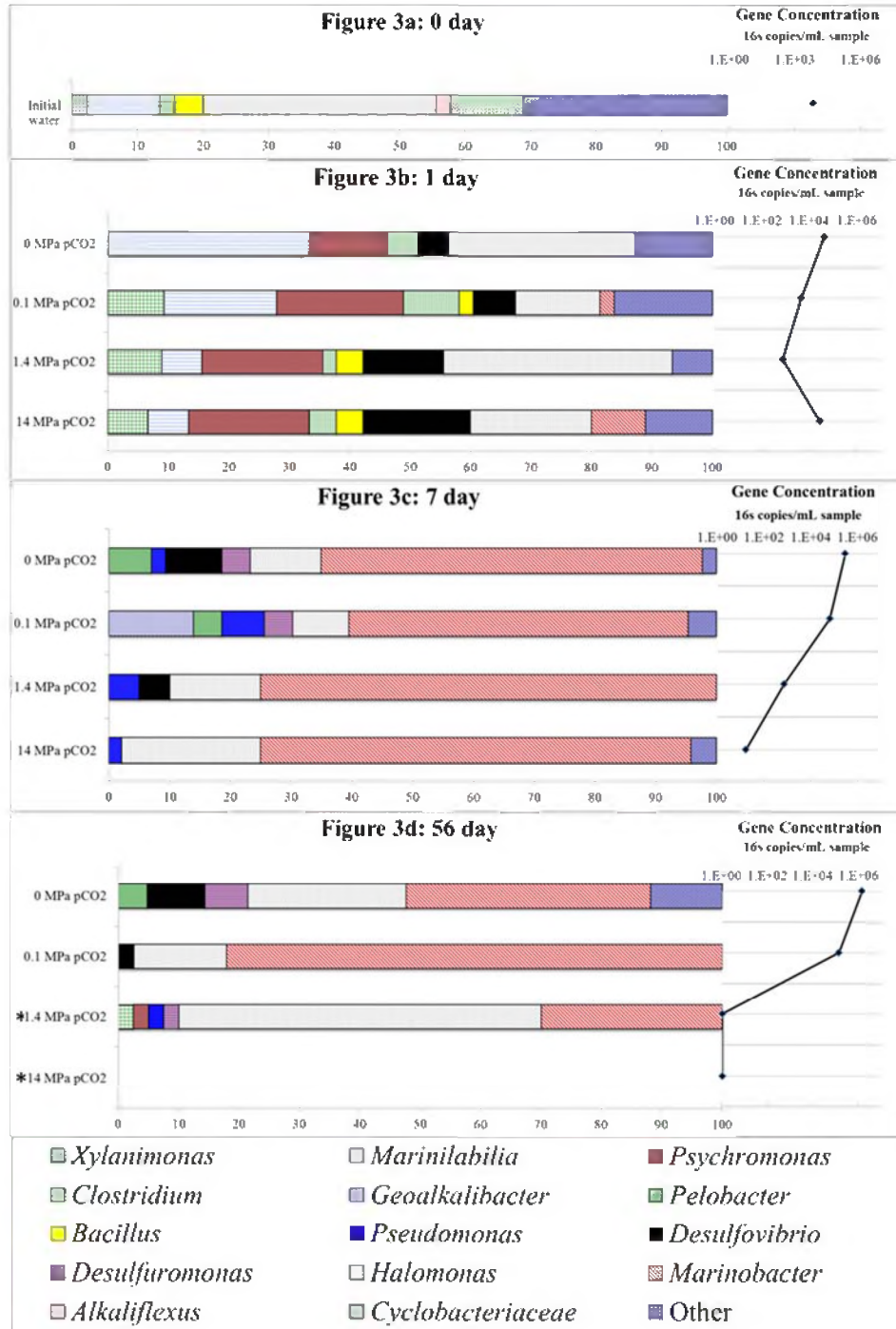
#### **3.1 IMPACT OF CO<sub>2</sub> ON THE EVOLUTION OF MICROBIAL COMMUNITIES FROM THE ARBUCKLE SALINE AQUIFER**

In order to understand the impact of pCO<sub>2</sub> on the microbial community from a future carbon sequestration site, samples of drill stem test water from the Arbuckle saline aquifer (1,220–1,460 m depth) were exposed to different pCO<sub>2</sub> (0, 0.1, 1.4 and 14 MPa of CO<sub>2</sub>) at formation temperature and pressure (40°C and 14 MPa). Reactors at each pCO<sub>2</sub> concentration were sacrificed after 1 day, 7 days, and 56 days of exposure. The microbial community was examined using a 16S rRNA gene clone library approach and gene copies were examined using quantitative PCR.

Some general trends in total recoverable 16S DNA are apparent upon exposure to different pCO<sub>2</sub> and over time. The 16s gene copies of the 0 MPa and 0.1 MPa reactors suggest microbial growth when compared to 16S gene copies of the initial water (Figure 1). In contrast, the 1.4 MPa and 14 MPa reactors had decreased 16S gene copies compared to the initial water, suggesting cell decay. In general, increasing pCO<sub>2</sub> and length of exposure accompanied a decrease in 16S rRNA gene copies recovered by qPCR (Figure 2). The effect of CO<sub>2</sub> can be seen in concentrations as low as 0.1 MPa; after 56 days of exposure to 0.1 MPa of CO<sub>2</sub>, the concentration of 16S rRNA genes had decreased by approximately an order of magnitude to 10<sup>5</sup> copies/mL compared to the 0 MPa CO<sub>2</sub> reactor. At higher pCO<sub>2</sub> exposure, the decrease was more severe and occurred in a shorter time. Only 7 days of 1.4 or 14 MPa pCO<sub>2</sub> exposure decreased the concentration of genes recovered to 10<sup>2</sup> and 10<sup>1</sup> copies/mL, respectively. After 56 days of exposure at 1.4 or 14 MPa, no 16S rRNA genes were detected using qPCR. Nested PCR was able to recover DNA from the 1.4 MPa reactor at very low concentrations (less than 1 copy/mL). At 1.4 MPa and 14 MPa pCO<sub>2</sub>, the decreasing concentration of 16S rRNA genes recovered over both exposure time and pCO<sub>2</sub> suggest that the number of cells in the reactors was declining.

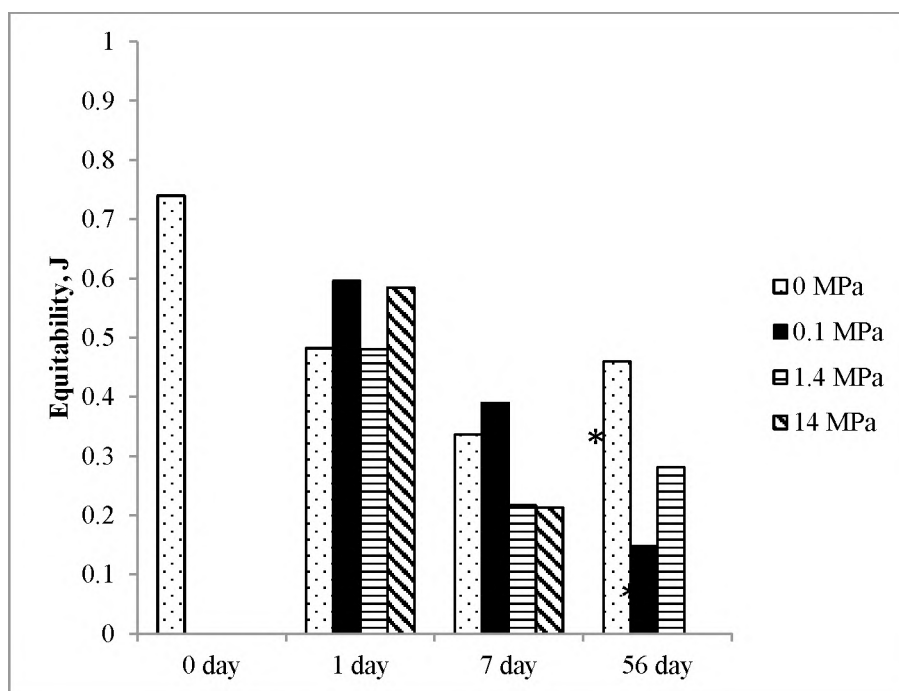


**Figure 1: Concentration of 16S rRNA gene copies recovered from reactors exposing unfiltered saline aquifer samples to increasing pCO<sub>2</sub> as revealed by qPCR for 0 days, 1 day, 7 days, and 56 days of exposure. Concentrations of genes are reported as gene copies/mL of drill stem test sample.**



**Figure 2: Relative proportions of phylotypes recovered from reactors exposing unfiltered saline aquifer samples to increasing pCO<sub>2</sub> as revealed by 16S rRNA gene clone libraries and qPCR for a) initial drill stem test sample, and following b) 1 day of exposure, c) 7 days of exposure, and d) 56 days of exposure. Clones were assigned a genera based on >97% similarity to cultured organisms. Clones with less than 97% similarity were characterized as “other”. The inset shows the concentration of 16S rRNA genes recovered by qPCR for each sample for a given pCO<sub>2</sub> exposure. Concentrations of genes are reported as gene copies/mL of drill stem test sample. \* = required nested PCR**

Results reveal that increasing pCO<sub>2</sub> decreases microbial diversity (Figure 3). Overall, fewer unique 16S rRNA genes were recovered over both increasing exposure times and increasing pCO<sub>2</sub> greater than 0.1 MPa. Equitability decreased from 0.74 in the initial water to as low as 0.28 after 56 days of exposure to 1.4 MPa CO<sub>2</sub> (Figure 3). After 56 days of exposure to any pCO<sub>2</sub>, the equitability decreased by more than 1.4 times over the initial water sample for all pCO<sub>2</sub> concentrations. It should be noted that the diversity percentage after 56 days of exposure to 1.4 MPa was estimated based on a nested PCR procedure, and may not directly compare to the other samples; the reported diversity was higher than expected by a single PCR amplification (as utilized for the other samples) and may be artefact from the nested PCR.



**Figure 3: Impact of exposure time and pCO<sub>2</sub> on microbial diversity of unfiltered saline aquifer samples. Results show the comparison of Equitability values (J) for each pCO<sub>2</sub> concentration examined with time. \*sample required nested PCR. A J = 0 is a pure culture, whereas J = 1 if each clone is a unique phylotype.**

Although the 16S clone library method only allowed observation trends in abundant microorganisms, utilized methods still reveal changes in the microbial community with increasing CO<sub>2</sub> concentration and exposure time. In all cases, the decreased microbial diversity with time and increasing pCO<sub>2</sub> was due to the selection of organisms with phylotypes most similar to cultured members of the genera, *Marinobacter* and *Halomonas* (Figure 2). Initially, the drill stem test water had 35% of the 16S rRNA genes that could be assigned to *Halomonas* and 0% of the 16S rRNA genes that could be assigned to *Marinobacter*. The lack of phylotypes associated with *Marinobacter* in the initial sample was likely due to a low cell population number that could not be detected utilizing the clone library method. After 7 days of exposure, the percentage of *Halomonas* and *Marinobacter* had increased above 65% of the community at each pCO<sub>2</sub> examined (Figure 2). After 56 days of exposure, the 0.1 and 1.4 MPa had 97% and

90% of their communities (respectively) similar to *Marinobacter* and *Halomonas*. After 56 days, the control reactor (0 MPa CO<sub>2</sub> exposure), was still enriched with phylotypes having the greatest similarity to *Halomonas* and *Marionbacter* genera (65%) and to a lesser degree *Desulfuromonas* (7%), *Desulfovibrio* (10%), and *Pelobacter* (5%). Organisms related to *Halomonas* and *Marinobacter* are known to be adaptive to high pressure, high temperature marine environments, as described later (Cui et al., 2008; Ma et al., 2010).

Concomitant with the decrease in diversity and 16S rRNA gene concentrations in the exposed water, a decrease in the relative proportions of initial sample phylotypes *Marinilabilia*, *Pelobacter*, *Xylanimonas*, and *Clostridia*, among others was observed. *Clostridia* (Leu et al. 1998), *Bacillus* (Huber et al., 2002; Sardessai et al., 2002), *Marinilabilia* (Goffredi and Orphan, 2010; Li et al., 2012) and *Psychromonas* (Ren et al., 2011) were previously isolated from saline subsurface environments and were observed to survive the initial 1 day exposure. Since the decrease of these phylotypes occurred after 7 days of incubation at all pCO<sub>2</sub> exposures, it is likely that temperature and pressure rapidly selected against these organisms, rather than CO<sub>2</sub> (Figure 2).

The survival and perhaps growth of halotolerant genera *Halomonas* and *Marinobacter*, and sulfate reducing genera *Desulfovibrio* and *Desulfomonas* in later incubation periods without CO<sub>2</sub> exposure is not surprising. These microbial populations have been identified in similar high saline, high pressure and temperature conditions. *Halomonas* are resistant to lysing in highly saline and extreme environments (Borin et al., 2008). Cultured strains of both *Halomonas* and *Marinobacter* are known to have a versatile metabolism, capable of degrading a variety of hydrocarbons in high salinity environments (Cui et al., 2008; Ma et al., 2010; Huu et al., 1999). *Halomonas* were found in oil field samples (Orphan et al., 2000) and marine and hypersaline environments (Biddle et al., 2005; Fry et al., 2008; Inagaki et al., 2003; van der Wielen et al., 2005) and are generally known for an ability to grow across a broad range of temperature and pH conditions (Arahal et al., 2008; Okamoto et al., 2004). Similarly, *Marinobacter* have been found in a variety of marine environments (D'Hondt et al., 2004; Gauthier et al., 1992) as well as oil fields (Orphan et al., 2000; Yakimov et al., 2007). Strains of *Desulfovibrio* have been isolated from ground water of deep granitic formations (Motamedi and Pedersen, 1998), as well as marine sediments (Parkes et al., 1994) and saline waters of a natural gas reserve (Basso et al., 2009). *Desulfomonas* has been found in saline subsurface environments such as hydrothermal vents (Huber et al., 2007) and oil fields (Magot et al., 2000). Indicating a potential linkage with the observed geochemistry, a higher population of sulfate reducers was observed in the reactor with lowest concentration of sulfate; 0 MPa pCO<sub>2</sub> exposure (Appendix A, Table A.1).

The adaptability of *Halomonas* and *Marinobacter* to temperature, pressure, and the salinity of the formation water is not surprising, however their adaptation to CO<sub>2</sub> contradicts findings in a review of high-pressure CO<sub>2</sub> for sterilization in the food industry suggesting that gram negative species are less tolerant of CO<sub>2</sub> exposure than gram positive organisms (Zhang et al., 2006). In the 0 MPa, 0.1 MPa, and 1.4 MPa reactors the phylotypes of the *Halomonas* genera were most closely related to the species, *Halomonas alimentaria*, (accession numbers HM583971.1, GU397400.1) representing 15% to 47% of the diversity. The phylotypes of the *Marinobacter* genera were closely related to *Marinobacter sp. M9(2010)* (accession number HQ433441.2) and *Marinobacter sp. TBZ126* (accession number HQ845769.1), representing 30% to 82% of the diversity. These *Marinobacter* and *Halomonas* species were isolated from hypersaline lakes in Iran. While it is uncertain whether these particular strains of *Halomonas* and *Marinobacter* will

affect reservoir capacity and integrity, species of these genera have been previously found capable of biofilm formation and biologically inducing carbonate mineralization (Sanchez-Roman et al., 2007; Naganuma et al., 2011) and warrant further study.

In order to separate the impact of pH and CO<sub>2</sub> on the microbial communities, two additional reactors were established in which the pH of the formation water was modified to represent the hydrogen ion concentration created by addition of 1.4 MPa CO<sub>2</sub>, but without CO<sub>2</sub> addition. The Arbuckle formation water obtained for these studies was poorly buffered by minimal amounts of suspended solids in the water (less than 0.5 g/L). The expected pH for a given pCO<sub>2</sub> was calculated using Geochemist Workbench with ICP-OES data (Appendix A, Table A.1) and measured initial sample alkalinity (of 388 mg/L HCO<sub>3</sub><sup>-</sup>) (Jackson et al., 2012). The calculations revealed that the expected pH decrease was from pH=7.8 in the initial unreacted water to pH=4.4 at pCO<sub>2</sub>=1.4 MPa. Therefore, formation water was acidified to pH=4.4 with HCl and maintained at an increased pH to 5.0 and 5.1 respectively. The microbial community was examined using the 16S rRNA genes approaches as before. The results from this pH-only control were compared to results obtained from the exposures to 1.4 MPa CO<sub>2</sub> (Figure 4). The addition of HCl to the vessel resulted in decreased rRNA gene copy numbers in a shorter period than the CO<sub>2</sub>-exposed vessels. The reasons for this are not clear. However, after a longer exposure time of 56 days, the vessels with only a pH change and no CO<sub>2</sub> exposure were found to contain five orders of magnitude more gene copies than the 1.4 MPa CO<sub>2</sub> vessel.

The diversity of the pH-only samples (0.34–0.37) is only slightly larger than the pCO<sub>2</sub> exposed samples (0.22–0.28) (Figure 5). This is still greatly reduced from the equitability of the initial water (0.74). The finding of *Halothiobacillus* and *Pseudoaltermonas* in the pH adjusted reactors suggests that they may be more resilient to lowered pH than CO<sub>2</sub> exposure. Similar to the CO<sub>2</sub> exposed water, the bacterial community shifted towards large populations of *Halomonas* and *Marinobacter*.



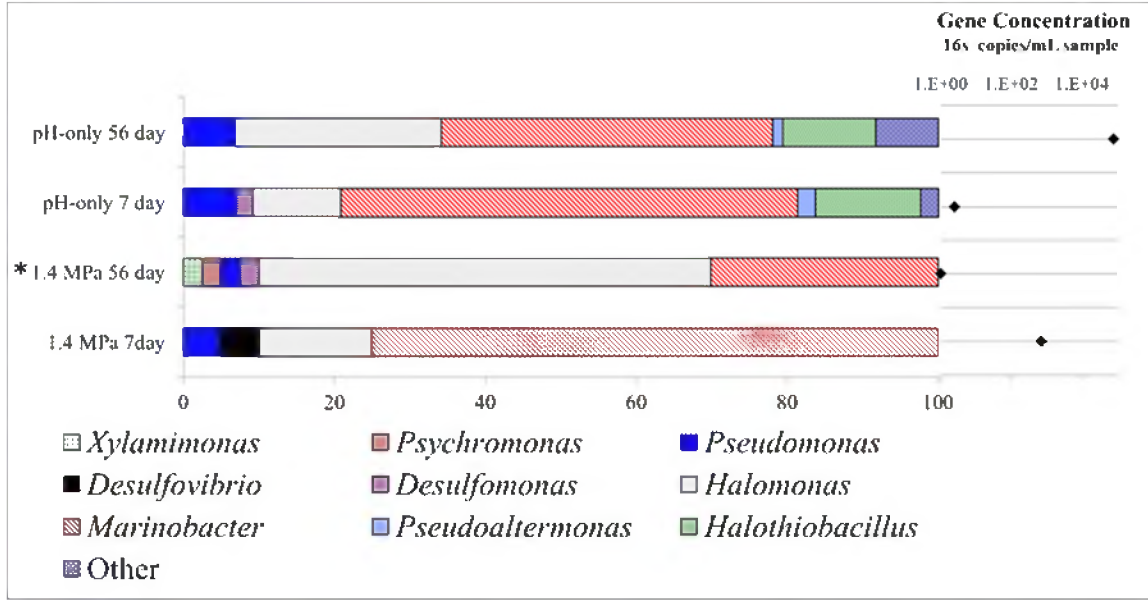


Figure 4: Microbial ecology characterized by 16S rRNA gene clone libraries and microbial population quantified by qPCR methods for 7 day and 56 day exposures to 1.4 MPa pCO<sub>2</sub> or the equivalent pH-only adjustment to 4.4. Clones were assigned a genera based on >97% similarity to cultured organisms. Clones with less than 97% similarity were characterized as “other”. \* = required nested PCR.

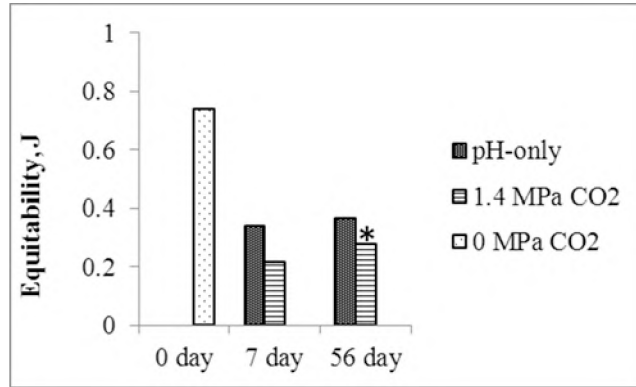


Figure 5: Impact of pCO<sub>2</sub> versus pH-only on microbial diversity of unfiltered saline aquifer samples. Results show the comparison of Equitability values (J) for each pCO<sub>2</sub> concentration examined with time. \*sample required nested PCR. A J = 0 is a pure culture, whereas J = 1 if each clone is a unique phylotype.

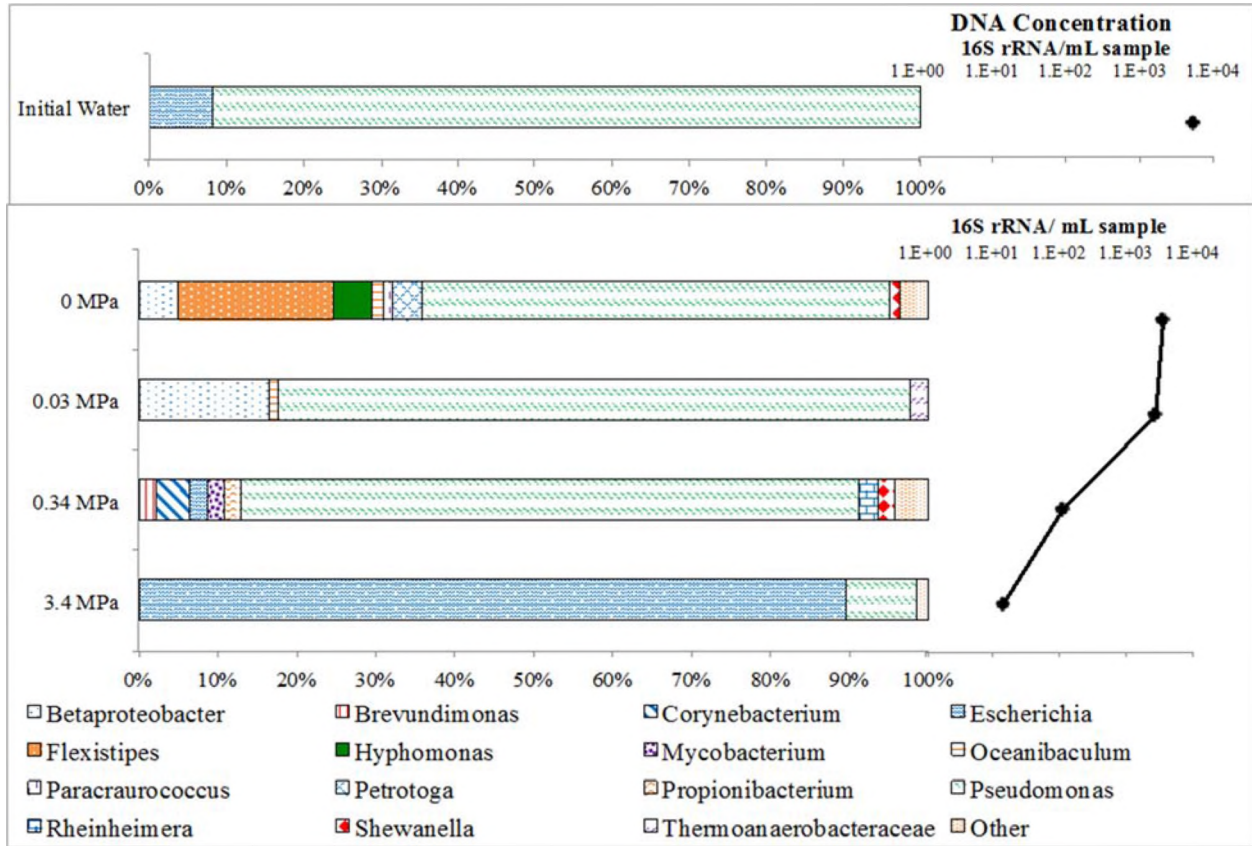
The results demonstrate that exposure of subsurface microbial communities to CO<sub>2</sub> will reduce both cell numbers and diversity. Cell growth was not hindered by a drop in pH to pH=4.4 without exposure to CO<sub>2</sub> implying that cell death was due to the increase in pCO<sub>2</sub>, and not the corresponding decrease in pH. In regions of high CO<sub>2</sub> concentration, biological processes (e.g. biomineralization of carbonate minerals) may be significantly hindered or absent. However, further from the CO<sub>2</sub> front, where cells will be exposed to CO<sub>2</sub> concentrations of 0.1 MPa or less,

microorganisms may still thrive; within these niches left by the heterogeneous flow of SC-CO<sub>2</sub>, biological processes will likely be retained. The organisms that survive and thrive may be targets for development of engineered processes to enhance beneficial outcomes (or minimize detrimental ones) for long-term CO<sub>2</sub> storage.

### **3.2 IMPACT OF CO<sub>2</sub> ON THE EVOLUTION OF MICROBIAL COMMUNITIES FROM THE MIRANDO OIL RESERVOIR**

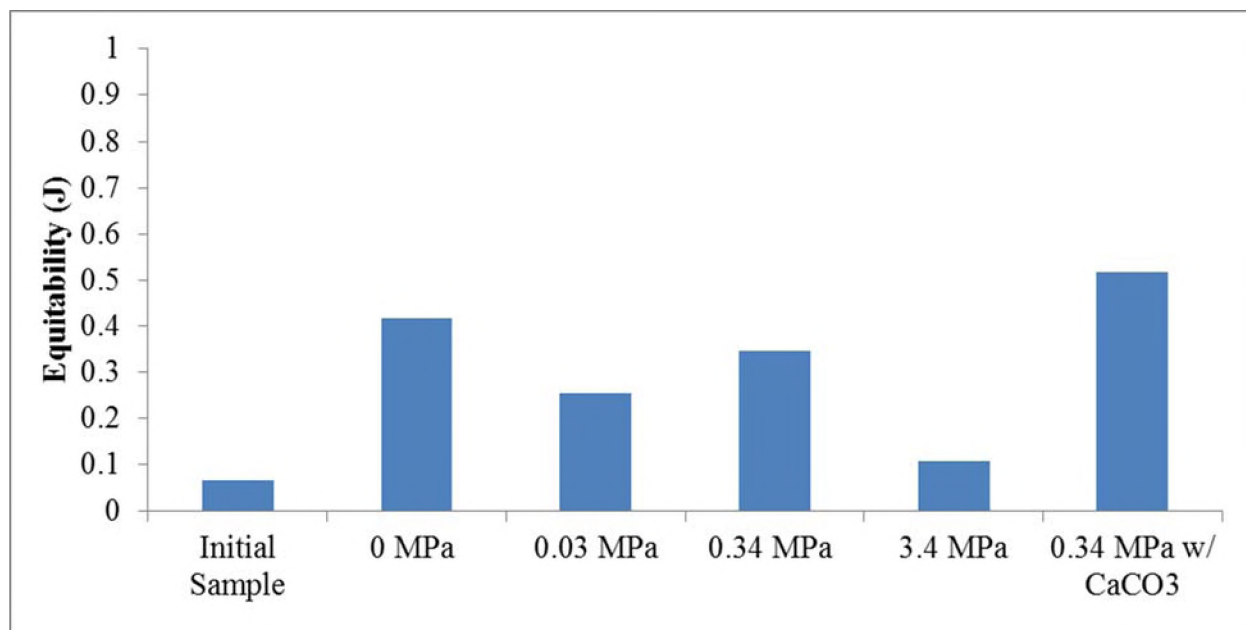
To explore the effect of CO<sub>2</sub> on microbial communities in depleted oil reservoirs, the change of the microbial community with CO<sub>2</sub> exposure was investigated with produced water samples from the Mirando Oil Reservoir, TX. Samples were placed in batch reactors with increasing pCO<sub>2</sub> (0, 0.03, 0.34, and 3.4 MPa) at reservoir total pressure (3.4 MPa) and temperature (40°C). Reactors were depressurized after 56 days and the microbial community was analyzed with qPCR, 16S rRNA clone libraries, and 454 pyrosequencing. The chemical analysis (ICP-OES, IC-anion, alkalinity, and total organic carbon (TOC)) of the initial water and after 56 days of exposure to different concentrations of CO<sub>2</sub>, as well as the modeled pH for CO<sub>2</sub>-exposed samples are given in Appendix A, Table A.3. The pyrosequencing data is given in Appendix B, Figure B.1.

Figure 6 indicates an adverse effect of CO<sub>2</sub> exposure on microorganisms in the produced water. Extractable DNA decreased significantly with increasing pCO<sub>2</sub> in the vessel. While the DNA concentration in the initial sample (the 0 MPa reactor) and the 0.03 MPa reactor remained around 10<sup>4</sup> gene copies/mL sample, the DNA concentration decreased to 10<sup>2</sup> gene copies/mL sample in the 0.34 MPa reactor and 10<sup>1</sup> gene copies/mL sample in the 3.4 MPa reactor.



**Figure 6: Relative proportions of phylotypes recovered from reactors exposing unfiltered produced water samples to increasing pCO<sub>2</sub> as revealed by 16S rRNA gene clone libraries and qPCR for a) initial produced fluid sample, and following b) 56 days of exposure to different pCO<sub>2</sub> values. Clones were assigned a genera based on >97% similarity to cultured organisms. Clones with less than 97% similarity were characterized as “other”.**

The microbial community diversity did not display a clear trend with increasing pCO<sub>2</sub> (Figure 7). Equitability was 0.42, 0.25, and 0.35 for the 0 MPa, 0.03 MPa, and 0.34 MPa pCO<sub>2</sub> reactors respectively. For pCO<sub>2</sub> exposures of 0.34 MPa or less, a majority of the sequences recovered from the microbial community were most similar to the genus *Pseudomonas*. This genus comprised 59–80% of the microbial community (Figure 6). For the pCO<sub>2</sub> exposure of 3.4 MPa, a majority of the sequences recovered from the microbial community was most similar to the genus *Escherichia*, representing 90% of the microbial community.



**Figure 7: Impact of 56 days of pCO<sub>2</sub> exposure on microbial diversity of unfiltered produced water samples. Results show the comparison of equitability values (J) for each pCO<sub>2</sub> concentration examined. A J = 0 occurs for a pure culture, whereas J = 1 occurs if each clone is a unique phylotype.**

Sequences most similar to the genus, *Pseudomonas*, is present in all of the samples, and dominant for pCO<sub>2</sub> < 0.34 MPa. A significant percentage (69–97%) of the *Pseudomonas* genus is closely related to the species *Pseudomonas stutzeri*, a common denitrifying species that has been isolated in soils, wastewaters, sea waters, and marine environments (Lalucat et al., 2006). Despite the absence of nitrate or nitrite in the produced water, the ubiquity of *Pseudomonas stutzeri* may be due to the versatility in metabolism, as this species is capable of utilizing a wide range of carbon sources as well as electron acceptors (Lalucat et al., 2006). The ability of the genus, *Pseudomonas*, to utilize gasoline-derived carbons and petroleum-derived carbons has previously been documented (Hino et al., 1997; Ridgway et al., 1990). Due to the prevalence of *Pseudomonas stutzeri* in the Mirando oil reservoir, even after CO<sub>2</sub> exposure, further study in the adaptability and biological processes of this species is warranted.

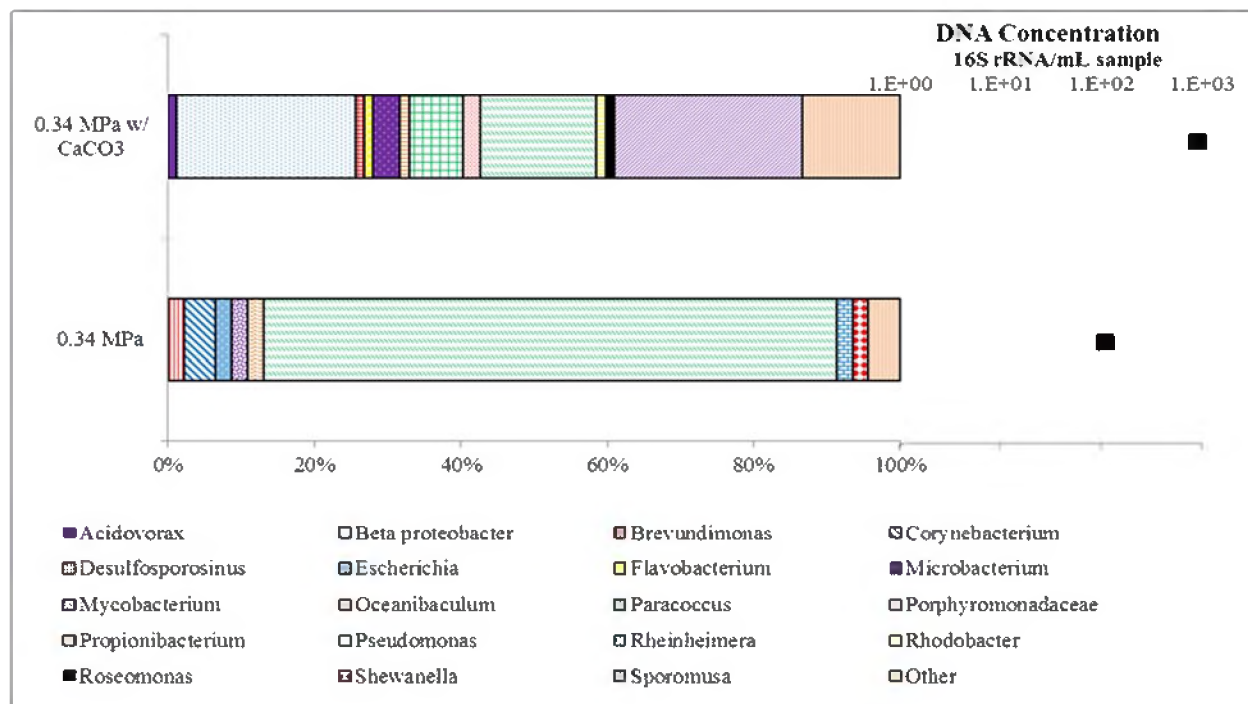
The 3.4 MPa reactor had the lowest diversity of 0.11 equitability (Figure 7) accompanied by the lowest proportion of sequences closely similar to *Pseudomonas* (Figure 6). While *Pseudomonas* appeared to be dominant in the initial sample, and the 0 MPa, 0.03 MPa, and the 0.34 MPa reactors, it only represented 9% at the highest CO<sub>2</sub> exposure of 3.4 MPa. *Pseudomonas stutzeri* has previously been shown to be incapable of surviving a pH less than 4.5 (Lalucat et al., 2006). The water in the reactor pressured with 3.4 MPa of CO<sub>2</sub> was modeled to have a pH of 4.3 (Appendix B, Table B.3); the *Pseudomonas stutzeri* may not have been adaptable to this decreased pH, resulting in cell decay.

At the highest pCO<sub>2</sub> exposure (3.4 MPa), a majority of sequences recovered were most closely similar to *Escherichia* (Figure 6). The species was most closely related to *Escherichia coli*, representing 94–100% of this genus amongst all samples. While *Escherichia* is often used as an

indicator of wastewater contamination, this genus is commonly introduced in natural sediments; *Escherichia* then adapts to the environmental conditions, becoming a dominant part of the native microbial community (Ishii and Sadowsky, 2008). The detection of *Escherichia coli* may be due to an introduction of the species during development of the Mirando production wells, followed by species adaption and survival in the reservoir. While *Escheria* appeared to be the most resilient to CO<sub>2</sub> exposures of 3.4 MPa or greater, the DNA concentration was only 10<sup>1</sup> gene copies/mL sample in this reactor. This suggests this genus is surviving, rather than thriving in this environment. Whether this species would continue to survive with longer exposure times still needs to be determined.

Although the Mirando oil reservoir material was primarily fine grained sand, some pH buffering may occur due to the dissolution of accessory clays. To determine if pH buffering can lessen the impact of CO<sub>2</sub> on the microbial community, an additional reactor was pressurized with sample, 10 mg/L CaCO<sub>3</sub>, and 0.34 MPa pCO<sub>2</sub> at reservoir temperature (40°C) and total pressure (3.4 MPa). The CaCO<sub>3</sub> addition to the vessel resulted in a final pH of 5.8 compared to a pH of 5.3 for the 0.34 MPa pCO<sub>2</sub> unbuffered reactor.

The buffered reactor had an increase in DNA concentration by an order of magnitude compared to the 10<sup>2</sup> gene copies/mL sample in the unbuffered reactor (Figure 8). This suggests the microbial community is stressed considerably at pH of 5.3 in the unbuffered 0.34 MPa reactor compared to the pH of 5.8 in the buffered 0.34 MPa reactor. However, the DNA concentration of the buffered reactor was still almost an order of magnitude less than the initial sample and the 0 MPa reactor, suggesting the buffered CO<sub>2</sub> exposure and pH=5.8 still stresses the microbial community. Moreover, the large effect on recoverable DNA for a 0.5 pH unit decrease suggests that the microbial communities are sensitive to changes over the pH range of 5.3 to 5.8; this incremental change in pH is expected to result from CO<sub>2</sub> injection (Kazuba et al., 2003; Kharaka et al., 2009; Smyth et al., 2009). Therefore CO<sub>2</sub> injection may lead to a decrease in microbial population even with buffering of accessory clays. Future studies on the effects of pH on the viability of microorganisms in this pH range are warranted.



**Figure 8: Relative proportions of phylotypes recovered from reactors exposing unfiltered produced water samples to increasing pCO<sub>2</sub> as revealed by 16S rRNA gene clone libraries and qPCR for 56 day exposures to 0.34 MPa pCO<sub>2</sub> or 0.34 MPa pCO<sub>2</sub> with CaCO<sub>3</sub> buffer. Clones were assigned a genera based on >97% similarity to cultured organisms. Clones with less than 97% similarity were characterized as “other”.**

The buffered reactor also had an increased diversity of 0.52 compared to the unbuffered 0.34 MPa reactor diversity (Figure 7). While *Pseudomonas* appeared to remain a dominant genus, representing 16% of the detected microbial community, the increased diversity appeared to be due to an emergence of *Sporomusa*, representing 26% of the community, and Betaproteobacter, representing 24% of the community (Figure 8). The phylotype of *Sporomusa* is most closely related to the species *Sporomusa malonica*. This homoacetogenic species has previously been found in anoxic freshwater sediments (Moller et al., 1984). The phylotype of Betaproteobacter is most closely related to a nitrogen fixing strain of *Betaproteobacter* that had been isolated from wild rice (unpublished, [AY235688](#)).

Clone libraries are one technique to characterize the species present in the fluid sample. Pyrosequencing is an alternative technique to determine the array of organisms comprising the surviving microbial community. The classes of organisms detected using pyrosequencing are compared with those of the 16S rRNA clone library data in Appendix B, Figure B.2. Overall, the classes detected by the pyrosequencing correlate with the classes detected by 16S clone libraries. The one exception to the correlation is that the class *Bacilli* was detected only in the 0.34 MPa reactor, only utilizing 454 pyrosequencing. This class was not detected in the 0.34 MPa reactor utilizing 16S clone libraries. The genus *Tumebacillus* represented over 99% of the *Bacilli* found in 454 pyrosequencing. This spore-forming genus has previously been isolated from industrial

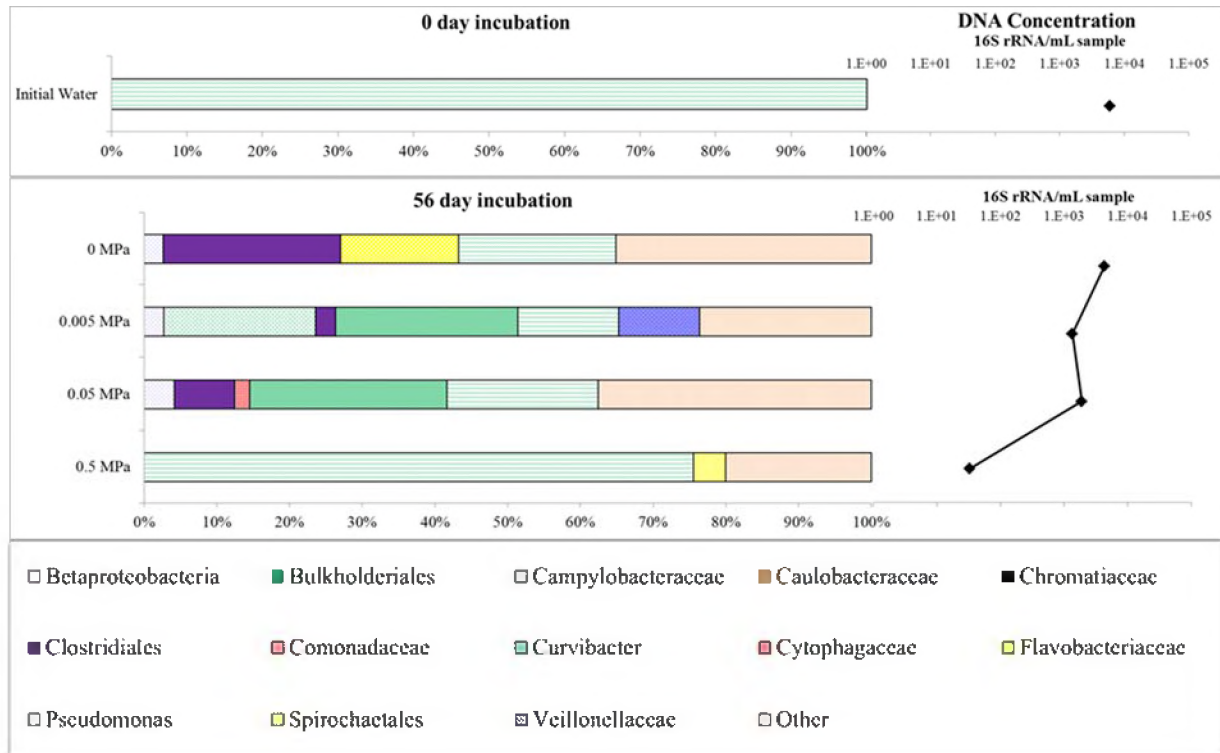
wastewater, methane hydrate-bearing sediments, and arctic permafrost samples (Lee et al., 2013; Steven et al., 2008; Wang et al., 2013).

This study begins to characterize the response of the microbial community that may be expected to occur in a depleted oil reservoir after CO<sub>2</sub> injection. The increasing CO<sub>2</sub> exposure correlated with a decrease in DNA concentration. The CO<sub>2</sub> tolerance of *Pseudomonas* and *Escherichia* suggests these genera to be relevant for future study of microbial CO<sub>2</sub> tolerance and microbial processes during carbon storage. Understanding which microorganisms may survive or thrive after CO<sub>2</sub> exposure will ultimately provide hypotheses for which microbial processes may affect petroleum quality and petroleum production in a CO<sub>2</sub> flooded oil reservoir.

### **3.3 IMPACT OF CO<sub>2</sub> ON THE EVOLUTION OF MICROBIAL COMMUNITIES FROM THE PLANT DANIEL FRESHWATER AQUIFER**

The effect of CO<sub>2</sub> leakage on a freshwater microbial community was examined in reactor vessels containing samples from the Plant Daniel freshwater aquifer and exposed to a range of pCO<sub>2</sub> that could be expected to accompany a leakage scenario. These samples, with no prior history of exposure to elevated CO<sub>2</sub>, were subjected to four different pCO<sub>2</sub> ranging from 0 MPa to 0.5 MPa at aquifer temperature (22°C) and pressure (0.5 MPa) in batch vessel reactors. Reactors were depressurized and sacrificed after 56 days of exposure. The microbial community was analyzed using qPCR and 16S rRNA gene clone libraries. Some geochemical and water quality parameters after exposure are presented in Appendix A, Table A.4, as well as the modeled pH and dissolved CO<sub>2</sub> for each pCO<sub>2</sub> condition.

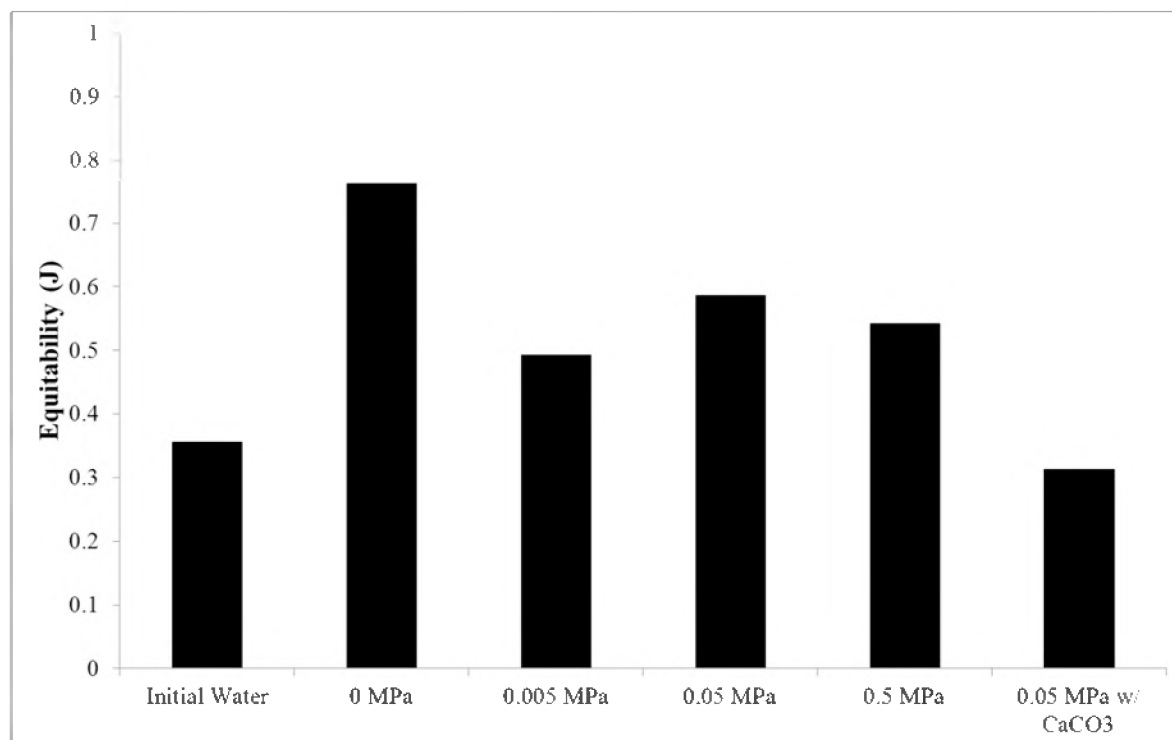
The bacterial 16S rRNA detected varied from 10<sup>3</sup> to 10<sup>4</sup> gene copies/mL, with the exception of the 0.5 MPa vessel pressurized for 56 days (Figure 9). This vessel had the lowest recoverable DNA concentration of only 10<sup>1</sup> gene copies/mL. The low DNA concentration in this vessel indicates a lethal stress of the highest CO<sub>2</sub> concentration. In contrast to the results observed at 0.5 MPa pCO<sub>2</sub>, the gene copy numbers were not significantly impacted at lower pCO<sub>2</sub> exposures (Figure 9), suggesting that only the community nearest to the source of the leakage may be lethally affected by the CO<sub>2</sub>. Below 0.05 MPa, the response of a mixed microbial community to CO<sub>2</sub> exposure may be an emergence of CO<sub>2</sub>-resilient microorganisms.



**Figure 9: Relative proportions of phylotypes recovered from reactors exposing unfiltered freshwater aquifer samples to increasing pCO<sub>2</sub> as revealed by 16S rRNA gene clone libraries and qPCR for a) initial drill stem test sample, and following b) 56 days of exposure. Clones were assigned a genera based on >97% similarity to cultured organisms. Clones with less than 97% similarity were characterized as “other”.**

Amongst the initial sample and all vessel samples, *Pseudomonas* emerges as a dominant genus in the microbial community (Figure 9). The most common species that represented the *Pseudomonas* genus were the ubiquitous soil species, *Pseudomonas fluorescens* (0–30%) and arsenic-oxidizing *Pseudomonas IK-S1* (25–35%) (Hamamura et al., 2013). Changes in the diversity of the microbial communities did not correlate with CO<sub>2</sub> concentration (Figure 10). Rather, the equitability varied from 0.31 to 0.76 with no distinct trend with respect to CO<sub>2</sub> exposure concentration.





**Figure 10: Impact of exposure time and pCO<sub>2</sub> on microbial diversity of unfiltered freshwater aquifer samples. Results show the comparison of Equitability values (J) for each pCO<sub>2</sub> concentration examined with time. A J = 0 occurs for a pure culture, whereas J = 1 occurs if each clone is a unique phylotype.**

Previous studies suggest differing adaptability of *Pseudomonas* depending on the strain and experiment. A variety of *Pseudomonas* strains have previously been adaptable in different environmental samples, such as marine sediment and water, freshwater sources, and agricultural soils (Peix et al., 2009). However, contrary to this study, Schulz et al. found a strain of *Pseudomonas* (*Pseudomonas putida*) to be sensitive to elevated CO<sub>2</sub>, with decreased growth after 50 hrs of 0.08 MPa pCO<sub>2</sub> exposure (Schulz et al., 2012). Gill and Tan (1979) found 0.01 MPa pCO<sub>2</sub> exposure stimulated growth of *Pseudomonas fluorescens*, while 0.02 MPa pCO<sub>2</sub> exposure inhibited growth. This study is the first to utilize a mixed microbial community from samples of the subsurface, and suggests *Pseudomonas* growth in environments with 0.05 MPa pCO<sub>2</sub> exposure. *Pseudomonas* is a known biofilm producer (Satpute et al., 2010; Hall-Stoodley et al., 2004; Watnick et al., 2000), and has been previously researched as a microbial mitigation strategy to reduce CO<sub>2</sub> leakage pathways (Cunningham et al., 2009). Additional research may determine the ability of *Pseudomonas* to produce a biofilm under the conditions of a CO<sub>2</sub>-leak that may serve to immobilize heavy metals in a CO<sub>2</sub> impacted aquifer.

The dominance of *Pseudomonas* in the 0.5 MPa vessel after 56 days suggests this genus is relatively resilient to stress caused by CO<sub>2</sub> exposure. However, this reactor had the lowest detectable DNA concentration of 10<sup>1</sup> gene copies/mL, suggesting *Pseudomonas* is merely surviving the CO<sub>2</sub> exposure as opposed to thriving in this system. Biological processes may

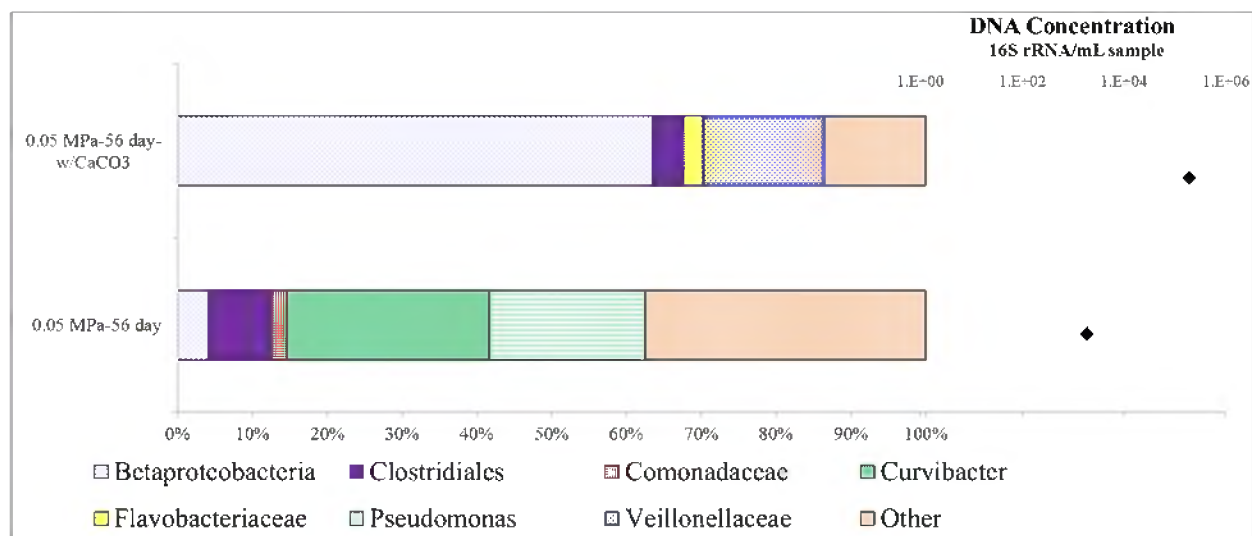
therefore not contribute strongly to geochemical processes affecting water quality at this high CO<sub>2</sub> concentration exposure.

A wider variety of genus appear adaptable to exposure to lower CO<sub>2</sub> concentrations, as *Curvibacter* also emerged as dominant bacteria in the 0.05 MPa and 0.005 MPa CO<sub>2</sub> concentration vessels, representing 25–27% of the community. The emergence of *Curvibacter* was accompanied by the disappearance of the spore-forming, soil bacteria, *Clostridiales* (Paredes-Sabja et al., 2011), and the common chemoorganotrophic freshwater bacteria, *Flavobacteriaceae* (Bernardet et al., 2002).

The enriched *Curvibacter* phylotypes were most similar to *Curvibacter delicatus*, a well water isolate that remains poorly characterized (Ding and Yokota, 2004). The emergence of *Curvibacter* may be due to adaptability to environmental stress, as this phylotype has previously been found to be resistant to antibiotics (Falcone-Dias et al., 2012). The lowest CO<sub>2</sub> concentration vessel of 0.005 MPa additionally was enriched in *Campylobacteraceae*, a common drinking water microorganism (Shah et al., 2012), and to a lesser extent, *Veillonellaceae*, a fermentative microorganism capable of CO<sub>2</sub> conversion to acetate (Moller et al., 1984). These results suggest a greater variety of genus will be adaptable at CO<sub>2</sub> concentrations expected further down-gradient from the CO<sub>2</sub> leakage source as compared to near the source of CO<sub>2</sub>.

To determine the effect of buffering that may have occurred in the field on the results measured here, an additional reactor with fluid sample and 10 g/L of CaCO<sub>3</sub> was pressurized with 0.05 MPa of pCO<sub>2</sub> under aquifer pressure (0.5 MPa) and temperature (25°C) for 56 days.

The buffered reactor demonstrated an order of magnitude higher DNA concentration as compared to the unbuffered reactor (Figure 11). This suggests that buffering from accessory clays may prevent the microbial population from decreasing to the extent observed in the 0.5 MPa CO<sub>2</sub> 56-day vessel. The dominant species found in the buffered reactors is a strain of *Betaproteobacteria* (64%) after 56 days. The phylotype is most closely related to a nitrogen fixing strain of *Betaproteobacteria* that had been isolated from wild rice; this phylotype is otherwise poorly characterized (unpublished, [AY235688](#) (Tan et. al., 2003)). The emergence of this *Betaproteobacteria* in the buffered reactors and the emergence of *Betaproteobacteria* closely related to *Curvibacter* in the 0.005 MPa and 0.05 MPa 56-day vessels suggest this class may be adaptable to CO<sub>2</sub> exposure in near neutral pH ranges.

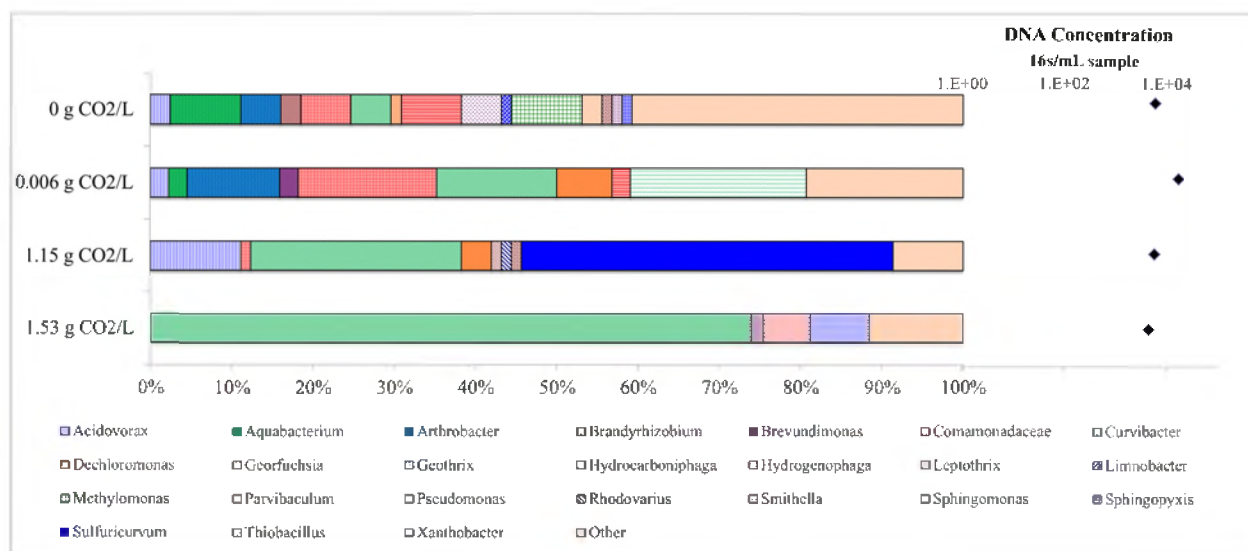


**Figure 11: Microbial ecology characterized by 16S rRNA gene clone libraries and microbial population quantified by qPCR methods for 56 day exposures to 0.05 MPa pCO<sub>2</sub> or 0.05 MPa pCO<sub>2</sub> with CaCO<sub>3</sub> buffer. Clones were assigned a genera based on >97% similarity to cultured organisms. Clones with less than 97% similarity were characterized as “other”.**

After 56 days of 0.05 MPa CO<sub>2</sub> exposure in the buffered reactor, *Methanobacterium* emerged as a dominant Archaea genus (Appendix B, Figure B.3). While the concentration of 16S rRNA was below detection for the unbuffered vessel samples, 10<sup>3</sup> 16S rRNA gene copies/mL sample were detected in the 0.05 MPa CO<sub>2</sub> vessel with buffering. *Methanobacterium* represented 100% of the detected Archaea in this reactor, with 77% most similar to the phylotype *Methanobacterium palustre*, and 33% most similar to the phylotype *Methanobacterium formicicum*. This suggests that this methanogenic Archaea was adaptable to the buffered CO<sub>2</sub> conditions, allowing this phylotype to grow and dominate in this environment.

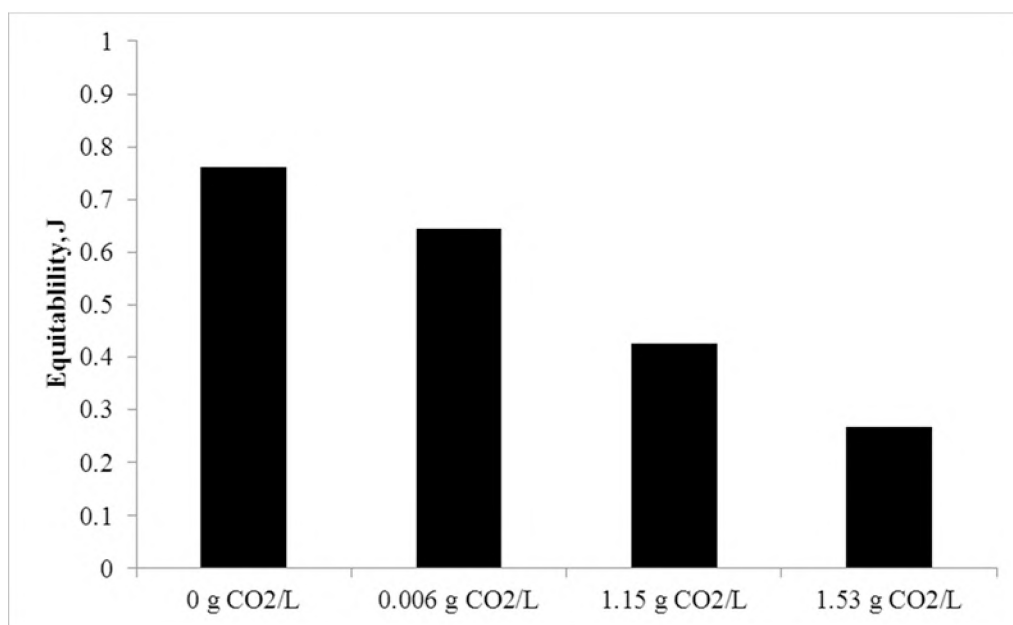
In order to determine the effectiveness of measuring microbial community changes with CO<sub>2</sub> exposure in the vessel experiment, these results were compared to shifts in microbial communities in groundwater samples taken during an *in situ* experiment conducted at the Plant Daniel site. CO<sub>2</sub> saturated groundwater was injected in the Plant Daniel freshwater aquifer, and dissolved CO<sub>2</sub> was measured in 3 downgradient wells (Trautz et al., 2013; Dafflon et al., 2013). These downgradient wells had a dissolved CO<sub>2</sub> concentration of 0.006 g CO<sub>2</sub>/L, 1.153 g CO<sub>2</sub>/L, and 1.53 g CO<sub>2</sub>/L. The microbial community of each downgradient well and one upgradient well (0 g CO<sub>2</sub>/L) was analyzed with qPCR, 454 pyrosequencing, and 16S rRNA clone libraries.

The 16S rRNA gene copies recovered by qPCR for the *in situ* experiment were between 10<sup>3</sup> and 10<sup>4</sup> gene copies/mL, and did not appear to correlate with measured dissolved CO<sub>2</sub> concentration (Figure 12). These results suggest that CO<sub>2</sub> exposure may not greatly affect the microbial population size at low CO<sub>2</sub> concentrations that would be expected from a CO<sub>2</sub> leak.



**Figure 12: Relative proportions of phylotypes recovered from unfiltered well samples downgradient of CO<sub>2</sub>-saturated-water injection well. Dissolved CO<sub>2</sub> of each well was measured by CarboQC and microbial community was revealed by 16S rRNA gene clone libraries and qPCR. Clones were assigned a genera based on >97% similarity to cultured organisms. Clones with less than 97% similarity were characterized as “other”.**

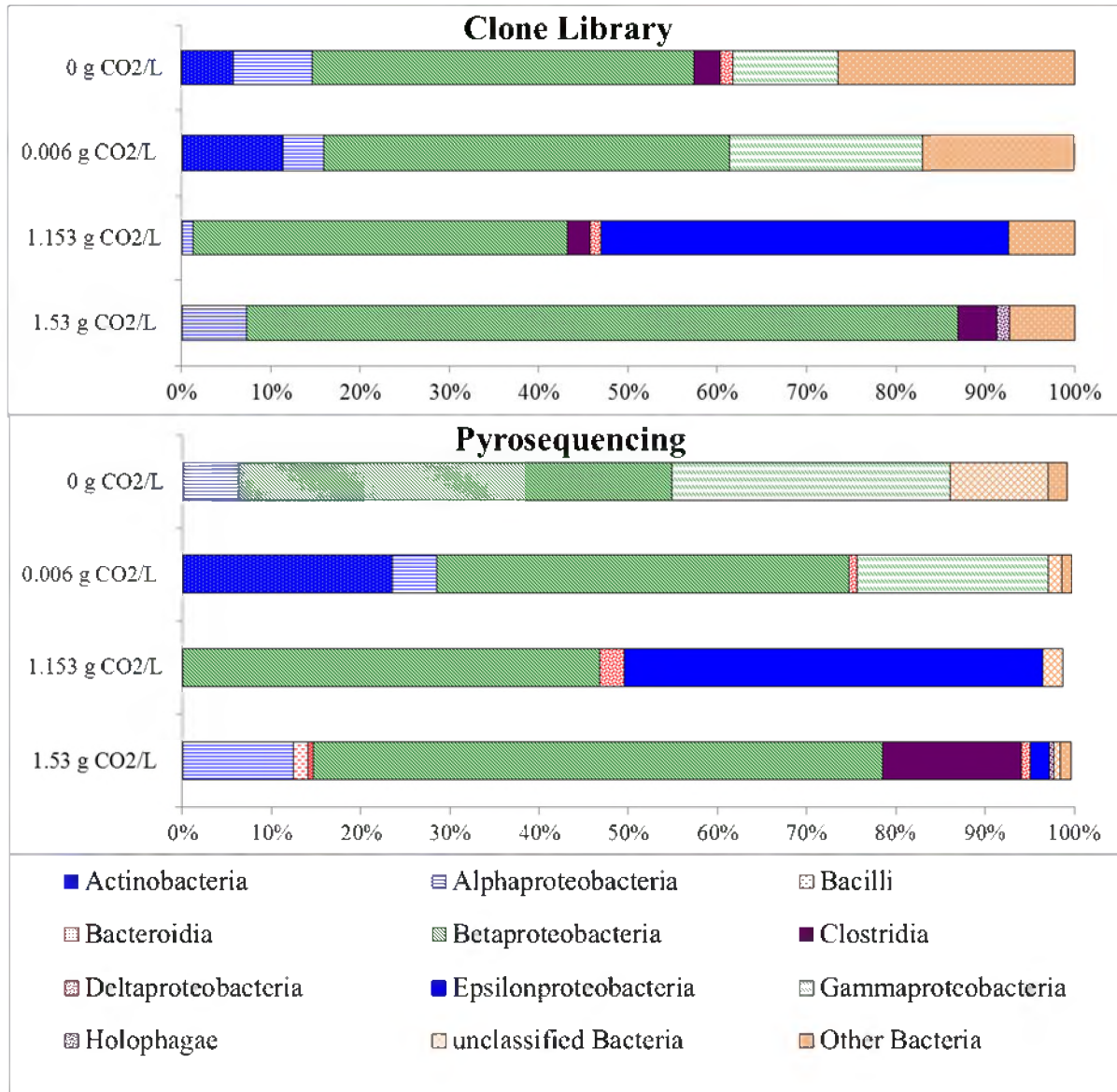
Although there was no apparent trend in DNA concentration with CO<sub>2</sub> exposure, the in situ experiment demonstrated a clear decrease in diversity with increasing dissolved CO<sub>2</sub> concentrations (Figure 13). Equitability decreased from 0.76 in samples with 0 MPa dissolved CO<sub>2</sub> to as low as 0.27 in samples with 1.5 g/L dissolved CO<sub>2</sub>. This decrease in diversity appears to be due to the emergence of *Curvibacter* as a dominant genus (Figure 12). *Curvibacter* only occupied 5% of the relative abundance in the 0 g/L dissolved CO<sub>2</sub> fluid, which increased to 15% in 0.006 g/L dissolved CO<sub>2</sub> fluid, 26% in 1.15 g/L dissolved CO<sub>2</sub> fluid, and 74% in 1.53 g/L dissolved CO<sub>2</sub> fluid. Similar to the reactor experiment, the enriched *Curvibacter* phylotypes were most similar to the well water isolate, *Curvibacter delicatus*. The 1.5 g/L dissolved CO<sub>2</sub> fluid was to a lesser degree also enriched in *Thiobacillus* (6%), a chemoautotrophic sulfur oxidizing bacteria (Vlasceanu et al., 1997), and *Xanthobacter* (7%), a freshwater bacteria (unpublished, [DQ664202](#) (Cho and Song, 2013)). These bacteria appear to be the most tolerant of low dissolved CO<sub>2</sub> concentrations.



**Figure 13: Impact of dissolved CO<sub>2</sub> on microbial diversity of unfiltered freshwater aquifer samples downgradient of CO<sub>2</sub>-saturated-water injection. Results show the comparison of Equitability values (J) for each pCO<sub>2</sub> concentration examined with time. A J = 0 occurs for a pure culture, whereas J = 1 occurs if each clone is a unique phylotype.**

The decrease of diversity was also due to the loss of abundance in ground water bacteria genus, such as the common freshwater bacteria, *Acidovorax* (Rickard et al., 2003) and *Arthrobacter* (Spring et al., 2000), *Hydrogenophaga*, a groundwater microorganism often associated with arsenic mobilization (Garcia-Dominguez et al., 2008; vanden Hoven et al., 2004), *Leptothrix*, a metal oxidizing microorganism (Corstjens et al., 1993; Vollrath et al., 2013), and *Methylomonas*, a freshwater methanotroph (Costello et al., 1999). These bacteria may be less resistant to low CO<sub>2</sub> concentrations, and will not be involved in microbial processes that affect aquifer parameters such as porosity, interstitial pH, and metal solubility. The apparent CO<sub>2</sub>-intolerance of metal mobilizing bacteria such as *Hydrogenophaga* and *Leptothrix* further suggests that metal solubility will be mostly dependent on geochemical processes (e.g. lowering of groundwater pH or changes in redox conditions) rather than biogeochemical processes. The reduced diversity and maintained DNA concentration demonstrates a dynamic microbial system that will adapt to various CO<sub>2</sub> exposures.

The pyrosequencing data displays a similar trend as the 16S rRNA clone library data (Figure 14). In both datasets, the overall abundant phylum was Proteobacteria representing 73–96% of the bacteria detected by pyrosequencing and 65–90% of the bacteria detected by 16S rRNA clone libraries. Within this phylum, Betaproteobacteria was the dominant class, representing 46–64% of the bacteria detected by pyrosequencing and 42–80% of the bacteria detected by 16S rRNA clone libraries.



**Figure 14: Comparison of 16S rRNA gene clone libraries and 454 pyrosequencing of relative proportions of phylotypes recovered from unfiltered well samples downgradient of CO<sub>2</sub>-saturated-water injection well. OTUs were assigned an order based on >97% similarity to cultured organisms. Clones with less than 97% similarity were characterized as “other”.**

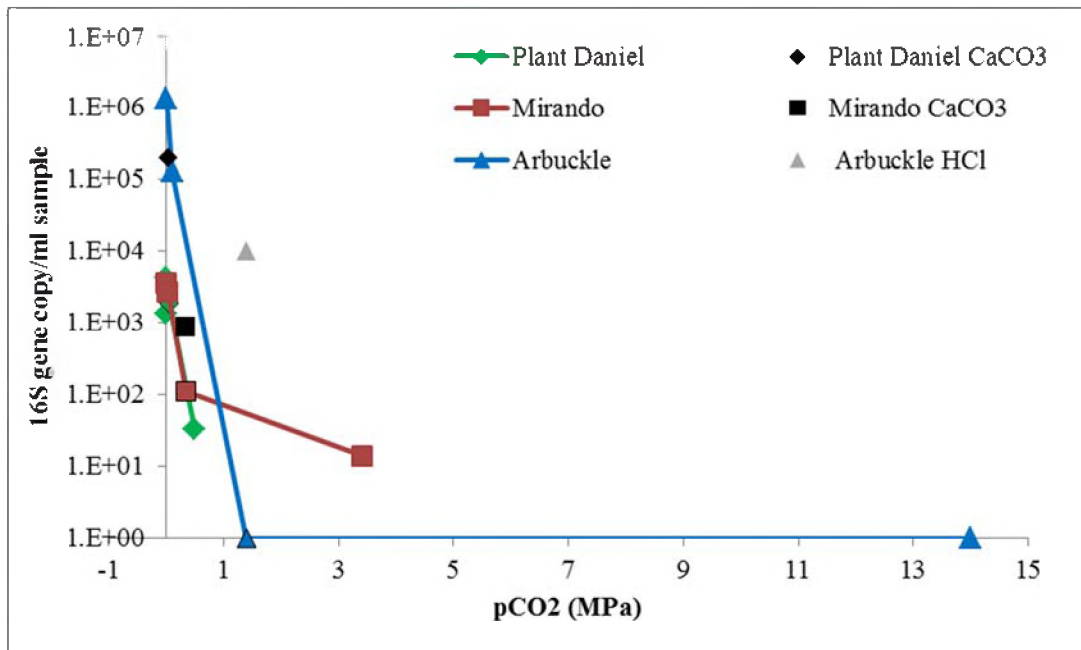
Although Archaea was not detected in the 16S rRNA clone library, pyrosequencing was able to detect Archaea to represent 1–7% of the total microbial community in the samples. The qPCR detected 10<sup>-1</sup>–10<sup>1</sup> gene copies/mL sample (Appendix B, Figure B.4). The dominant classes of the Archaea present were the anaerobic methanogens, *Methanomicrobia* and *Methanobacteria* (Appendix B, Figure B.4). The presence of the strictly anaerobic methanogen, demonstrates an impacted aquifer will contain an anaerobic niche for these types of species to survive. However, the small percent representation of the Archaea suggests that although these microorganisms may

survive CO<sub>2</sub> leakage conditions, methanogenesis will not likely be a dominant metabolism in the freshwater environment.

Consistent with the reactor experiment, the *in situ* experiment demonstrated an adaptable community will arise after CO<sub>2</sub> leakage in a freshwater aquifer. DNA concentrations remained between 10<sup>3</sup>–10<sup>4</sup> gene copies/mL sample in CO<sub>2</sub> exposures as high as 1.53 g CO<sub>2</sub>/L. Increasing CO<sub>2</sub> concentrations accompanied a decrease in diversity as *Curvibacter* emerged as a dominant genus of the microbial community. This further suggests *Curvibacter* will be adaptable to CO<sub>2</sub> leakage conditions.

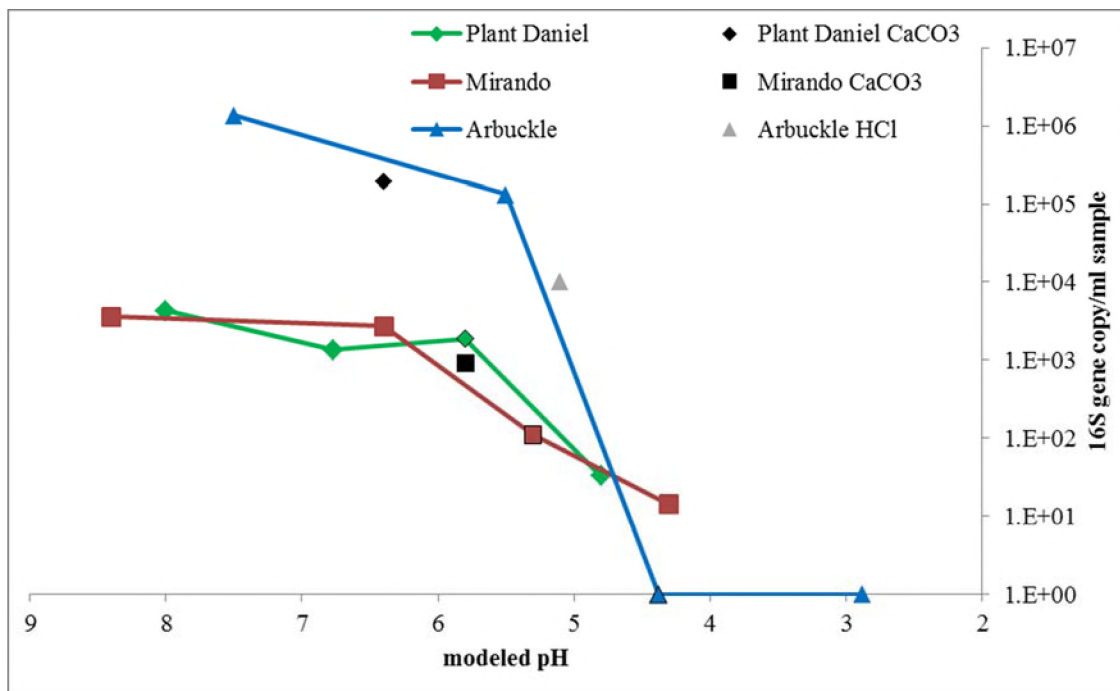
### 3.4 COMPARISON OF IMPACT OF CO<sub>2</sub> ON THE EVOLUTION OF MICROBIAL COMMUNITIES

In order to identify trends in microbial community changes that occurred as a result of CO<sub>2</sub> exposure, results from vessel experiments containing different subsurface site water samples were compared. The detected 16S gene copies/mL sample decreased with increasing pCO<sub>2</sub> across all three sites (Figure 15). This suggests that CO<sub>2</sub> exposure in all subsurface sites will result in greater loss in cell numbers closer to the injection/leakage point where CO<sub>2</sub> concentration would be highest. The Plant Daniel and Mirando samples exhibited higher 16S rRNA gene copy concentration in vessels with CaCO<sub>3</sub> buffering (i.e. higher pH) as compared to vessels without buffering at the same pCO<sub>2</sub> exposure. This suggests the decrease in DNA concentration was primarily due to the CO<sub>2</sub>-driven pH decrease in these two waters.



**Figure 15: DNA concentration of the Plant Daniel freshwater aquifer, the Mirando depleted oil reservoir, and the Arbuckle saline aquifer versus 0–14 MPa pCO<sub>2</sub>. Black data represent samples in presence of 0.05 MPa and 0.34 MPa pCO<sub>2</sub> and 10 g/L CaCO<sub>3</sub>. The grey datum represents a sample examined to understand the effect of pH by adjusting the pH to 4.4 (initial) and 5.1 (final) with HCl in the absence of CO<sub>2</sub> exposure.**

The decrease of 16S gene copies/mL sample detected with decreasing pH across all three sites is shown in Figure 16. All samples, including the CaCO<sub>3</sub> buffered samples show decreasing 16S gene copies/mL sample as pH is decreased. The effect appears greatest below about pH=5.5 to 6.5 for all sites. However, each site responds differently to this changing pH. Thus, there appears to be a site dependence of pH effect on DNA concentration. It is noteworthy that the Plant Daniel vessel with buffer increases 16S rRNA gene copy concentration by 2 orders of magnitude compared to unbuffered reactors. In this case, it appears the CaCO<sub>3</sub> buffer promoted growth within the Plant Daniel microbial community. This result might have been due to an emergence of a microbial community that benefitted from the addition of CaCO<sub>3</sub>. Regardless, the results across all three sites suggest a buffered aquifer or reservoir will reduce the largely pH-driven effects of CO<sub>2</sub> exposure on the microbial community.

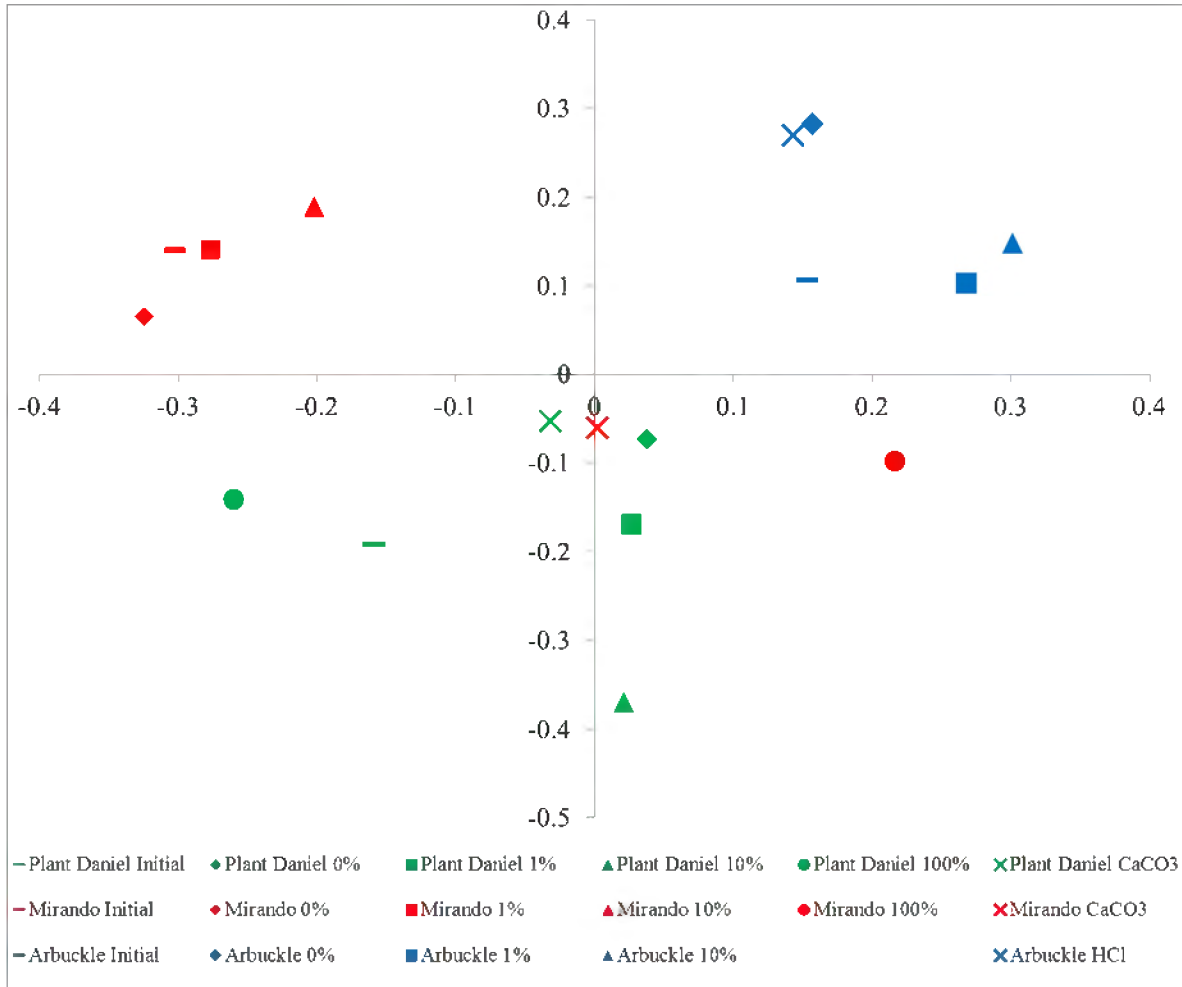


**Figure 16: DNA concentration of the Plant Daniel freshwater aquifer, the Miranda depleted oil reservoir, and the Arbuckle saline aquifer measured by qPCR for modeled pH. Black data represent samples in presence of 0.05 MPa and 0.34 MPa pCO<sub>2</sub> and 10 g/L CaCO<sub>3</sub>. The grey datum represents a sample examined to understand the effect of pH by adjusting the pH to 4.4 (initial) and 5.1 (final) with HCl in the absence of CO<sub>2</sub> exposure.**

In order to visualize the magnitude of phylogenetic differences between each sample, a distance matrix was made, and a UniFrac plot was created with a principle component analysis, using PC1 and PC2 as the x and y axis respectively. The UniFrac plot (Figure 17) clearly demonstrates that the change in microbial community due to CO<sub>2</sub> exposure is affected by site specific conditions. Generally, sequences clustered closest to other sequences from the same site as opposed to clustering with pH or with pCO<sub>2</sub> exposure. This suggests the change of microbial community with increasing CO<sub>2</sub> exposure will be different among various subsurface sites, and no clear trends emerged regarding a dominant microbial community. Each site had different

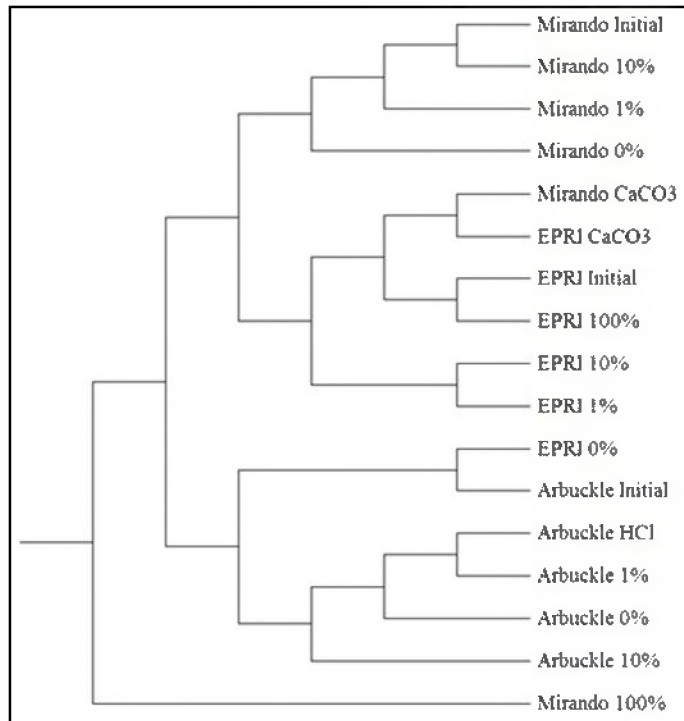


conditions such as pressure, temperature, and dissolved ion concentrations (Appendix A, Table A.1, A.3, A.4), and the results are indicative of the strong influence of site conditions on microbial communities.



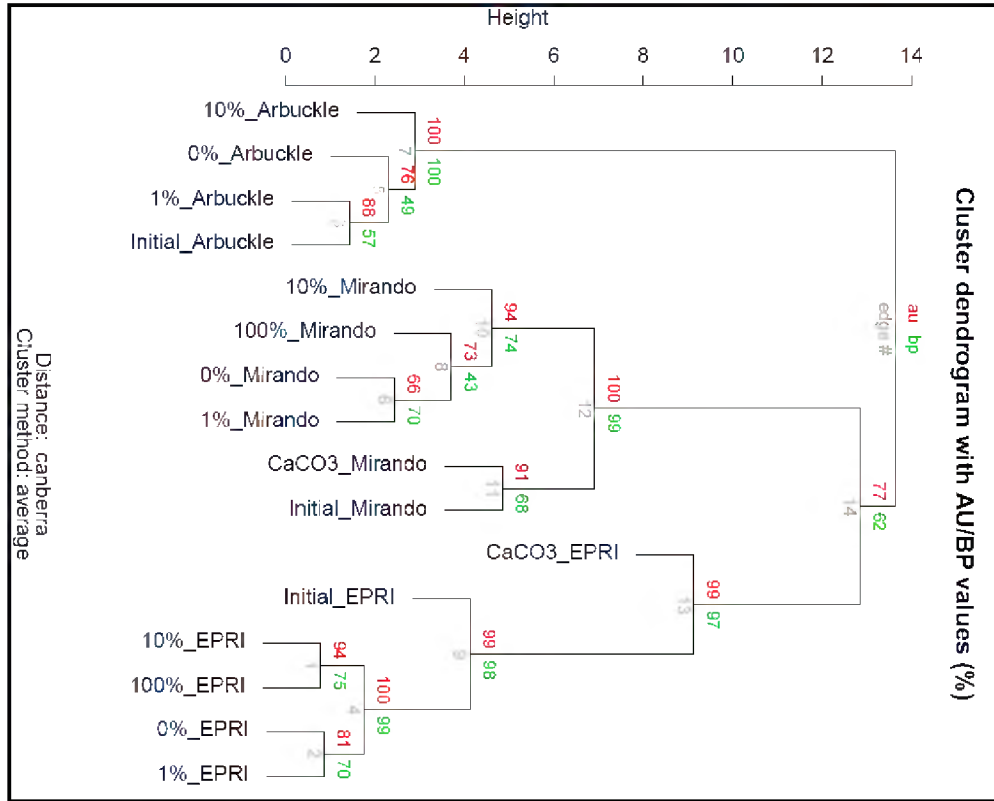
**Figure 17: Unifrac plot of sequences recovered from vessel experiments with Plant Daniel freshwater aquifer sample, Mirando oil reservoir sample, and Arbuckle saline aquifer sample.**

The community tree similarly displays the DNA sequences clustered closely by site (Figure 18). The genera that emerged in each study appeared to be unique to the formation and conditions used in that study. This further suggests the emerging microbial community in CO<sub>2</sub> exposed environments will be site dependent. The site dependent results suggest that the results determined in this thesis for the three selected sites may not provide general predictions of the dominant microbial species expected to emerge at CO<sub>2</sub> exposed subsurface sites.



**Figure 18: Community tree calculated by Yue and Clayton (Yue and Clayton, 2005) theta diversity index of sequences recovered from vessel experiments with Plant Daniel freshwater aquifer sample, Mirando oil reservoir sample, and Arbuckle saline aquifer sample.**

The site dependence on the geochemistry is illustrated in Figure 19. Similar to the site-clustering illustrated for DNA sequences in the Unifrac plot (Figure 17) and microbial community tree (Figure 18), the geochemistry of each sample most closely clusters to samples from the same site. Although both the DNA sequences and the geochemistry appears to cluster closely by site, comparison of the distance matrix calculated by OTU and distance matrix calculated for geochemistry results in a correlation coefficient of 0.55. This suggests that the correlation between the changes in the microbial community and changes in the geochemistry is only slightly positive. The low correlation coefficient despite obvious site clustering for both distance matrices suggest a difficulty in comparing DNA sequencing models to geochemistry models. However, the site dependence of the emerging microbial communities may be closer correlated to the initial microbial community, rather than geochemical parameters.



**Figure 19: Dendrogram of distance matrix calculated for the geochemistry of each sample utilizing the canberra equation.**

This analysis provides some initial understanding of the effect of CO<sub>2</sub> injection or CO<sub>2</sub> leakage on microbial communities in selected environments. Microbial communities from a saline aquifer, a depleted oil reservoir, and a freshwater aquifer were exposed to increasing CO<sub>2</sub> concentrations and characterized with qPCR and 16S rRNA gene clone libraries. 16S rRNA gene copy concentrations decreased with increasing CO<sub>2</sub> exposure across all three sites. The trend in decreasing DNA concentration was found to be highly dependent on pH, with reduced pH resulting in a lower number of extractable 16S gene copies. Sequences from the dominant microbial communities at various CO<sub>2</sub> exposures appeared to cluster by site, suggesting the adapted microbial community that emerges during carbon storage or CO<sub>2</sub> leakage will be site/condition dependent. Overall, the results imply that exposure to CO<sub>2</sub> will result in pH-dependent decreased microbial growth, but that no trend in the emerging microbial species can be expected.

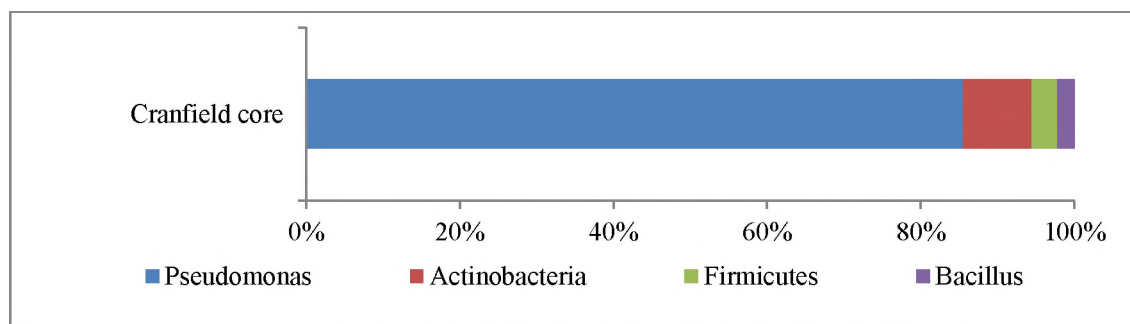
### 3.5 FAILED EXPERIMENTS

#### Cranfield Saline Formation

To understand the effect of CO<sub>2</sub> injection on microbial communities in deep saline formations storage sites, the microbial community changes in samples from the Cranfield saline formation with CO<sub>2</sub> exposure was investigated. Although qPCR methods did not detect DNA in core sediment sample or in fluid sample, nested PCR of DNA extracted from the core sediment (before the pressure vessel experiments) allowed microbial community characterization via 16S rRNA clone library (Figure 20).

Fluid and sediment core samples were then placed in batch reactors with and without 50% pCO<sub>2</sub> (0 MPa and 13 MPa) at reservoir total pressure (26 MPa) and two temperatures (55°C and 80°C). Although reservoir temperature was 120–130°C, the 55°C and 80°C were utilized in pressure vessel experiments to represent peak mesophilic conditions and thermophilic conditions. Reactors were depressurized after 42 and 168 days, DNA was extracted via two procedures, and the microbial community was analyzed with qPCR and PCR procedures. However, due to low biomass, qPCR and PCR procedures did not recover any DNA.

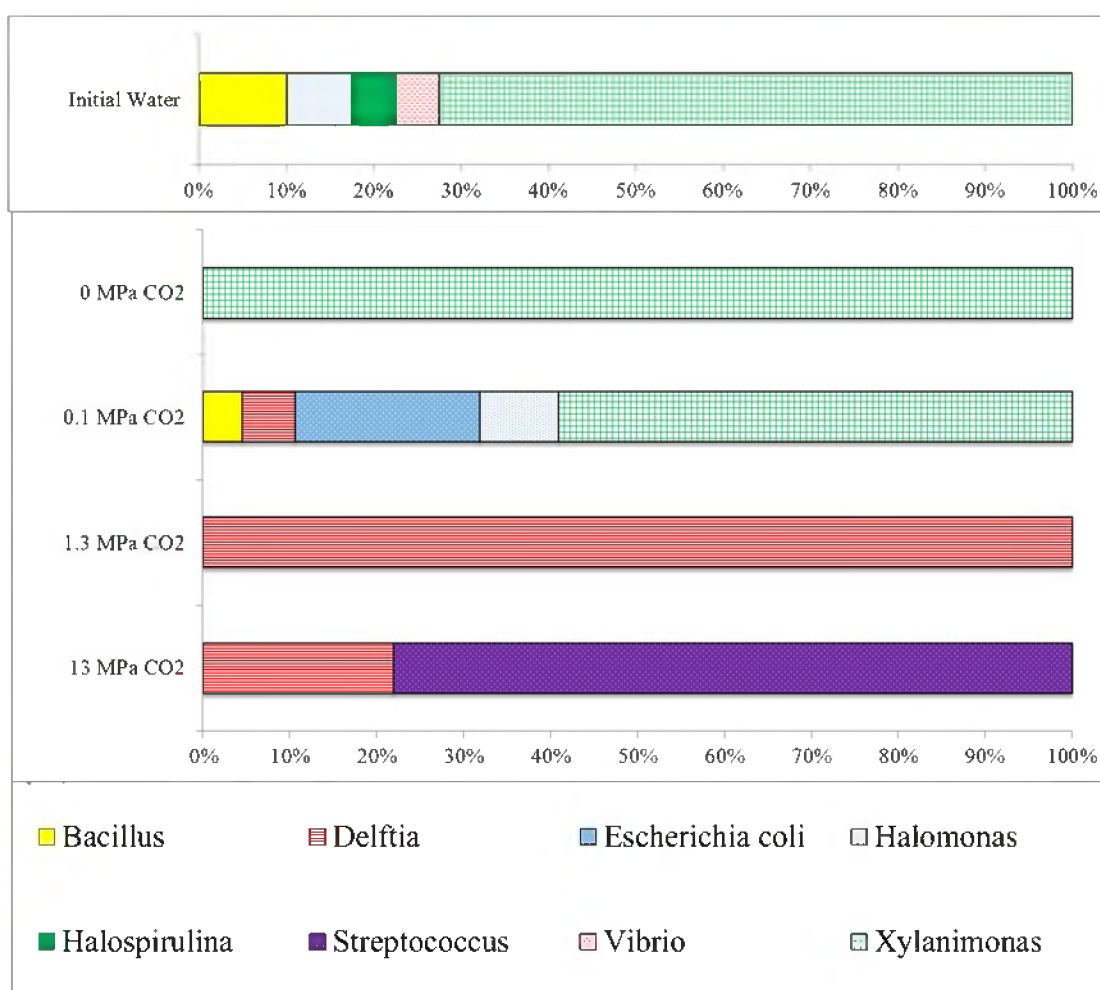
The genus *Pseudomonas* appeared to represent a majority of the microbial community detected in the core material (Figure 20). However, the lack of DNA in samples analyzed from any of the vessels prevented comparisons and further work on this site. The low biomass may be due to the high temperatures of the Cranfield aquifer, at 120–130°C. With a few exceptions (Kashefi and Lovley, 2003; Kurr et al., 1991), most of the known extremophiles that have adapted to survive high temperature conditions have a maximum temperature threshold of 110°C (Madigan et al., 2008). It is unlikely that the lack of DNA was a result of PCR inhibition from the sample given that the dilution series did not provide improved amplification of DNA, and the other saline aquifer site (Arbuckle, KS) studied showed no PCR inhibition. Similarly, it is unlikely that the lack of DNA was a result of ineffective DNA extraction, given that two separate extraction procedures were utilized, and both failed to recover DNA. However, the lack of a positive control (DNA spiked sample) cannot rule out PCR inhibition or ineffective DNA extraction.



**Figure 20: Relative proportions of phylotypes recovered from core sediment material from the Cranfield saline aquifer as revealed by 16S rRNA gene clone libraries. Clones were assigned a genera based on >97% similarity to cultured organisms. Clones with less than 97% similarity were characterized as “other”.**

### Mississippi Depleted Oil Reservoir

To understand the effect of CO<sub>2</sub> on microbial communities in depleted oil reservoirs, the microbial community changes in samples from the Mississippi oil reservoir with CO<sub>2</sub> exposure were investigated. Samples were placed in batch reactors with increasing pCO<sub>2</sub> (0, 0.1, 1.3, and 13 MPa) at reservoir total pressure (13 MPa) and temperature (40°C). Reactors were depressurized after 56 days and the microbial community was analyzed with qPCR and 16S rRNA clone libraries. Dilution of the extracted DNA from the exposure experiments suggested the occurrence of PCR inhibition, and extracted DNA was diluted by 200 times during the PCR procedure to optimize DNA amplification. Due to PCR inhibition, qPCR methods did not detect any DNA. Nested PCR of diluted DNA template allowed DNA analysis via 16S rRNA clone libraries (Figure 21).



**Figure 21: Relative proportions of phylotypes recovered from reactors exposing unfiltered Mississippi oil reservoir samples to increasing pCO<sub>2</sub> as revealed by 16S rRNA gene clone libraries for initial drill stem test sample, and following 56 days of exposure. Clones were assigned a genera based on >97% similarity to cultured organisms. Clones with less than 97% similarity were characterized as “other”. Nested PCR was utilized for all samples.**

Exposure experiments with the Mississippi sample followed by nested PCR procedures did result in sufficient DNA to complete 16S rRNA clone library procedures. The phylogenetic data obtained from the 16S rRNA clone libraries is presented in Figure 21.

The 16S rRNA gene copies recovered were most similar to the genera, *Bacillus*, *Halomonas*, and *Xylanimonas*, which also appeared to be present in the underlying Arbuckle saline formation. The genus, *Escherichia*, which appeared to be present in the Mississippi vessel samples, was also a dominant genus in another enhanced oil recovery (EOR) site sample, the Mirando oil reservoir samples. Although the emerging microorganisms in the Mississippi pressure vessel samples appeared to be consistent with these other site samples, this data was not publishable, due to the lack of qPCR data, and due to the potential increase of PCR-bias with nested PCR procedures. Samples from the Mississippi oil reservoir were therefore determined to have a combination of too low DNA concentration and too much PCR inhibition to merit further microbial community analysis.

#### East Seminole Depleted Oil Reservoir

To understand the effect of CO<sub>2</sub> on microbial communities in depleted oil reservoirs, the microbial community changes in samples from the East Seminole oil reservoir with CO<sub>2</sub> exposure was investigated. Samples were placed in batch reactors with increasing pCO<sub>2</sub> (0, 0.2, 2, and 20 MPa) at reservoir total pressure (20 MPa) and temperature (43°C). Reactors were depressurized after 56 days and the microbial community was analyzed with qPCR and PCR. Additionally, the microbial community from filters of 1.5 L fluid sample from three producing wells was analyzed with qPCR and PCR methods. No DNA was detected utilizing qPCR procedures and PCR procedures for the reactor samples and the produced water filters.

The low DNA concentrations from the East Seminole oil reservoir samples were surprising, as this site had a history of hydrogen sulfide production, which is a known microbial process (Gieg, 2011). The lack of DNA may have been due to a PCR inhibition; however, failure to recover DNA after a dilution series suggests PCR inhibition as unlikely. The produced samples contained less than 0.5 g/L solids, and the lack of DNA may be due to a filtering process that occurred before the fluid sample was received at the wellhead. For example, installation of the production well may have involved a down-hole screen that filtered sediment and biosolids before fluid collection at the top of the wellhead. It is still unknown whether the low DNA concentration in East Seminole samples was due to a filtering process before fluid collection at the wellhead, or due to a low microbial population in the reservoir. Regardless, the lack of amplified DNA from all East Seminole samples suggested the DNA concentrations were to be too low to merit further microbial community analysis.

#### Emma Oil Field

To understand the effect of CO<sub>2</sub> on native microbial communities in depleted oil reservoirs, the change of the microbial community with CO<sub>2</sub> exposure was investigated with samples from the Emma Oil Field, TX. Samples were placed in batch reactors with increasing pCO<sub>2</sub> (0, 0.2, 2, and 20 MPa) at reservoir total pressure (20 MPa) and temperature (37°C). Reactors were depressurized after 56 days and the microbial community was analyzed with qPCR and PCR procedures. Additionally, the microbial community from filters of 1.5 L fluid samples from three producing wells was analyzed with qPCR and PCR.

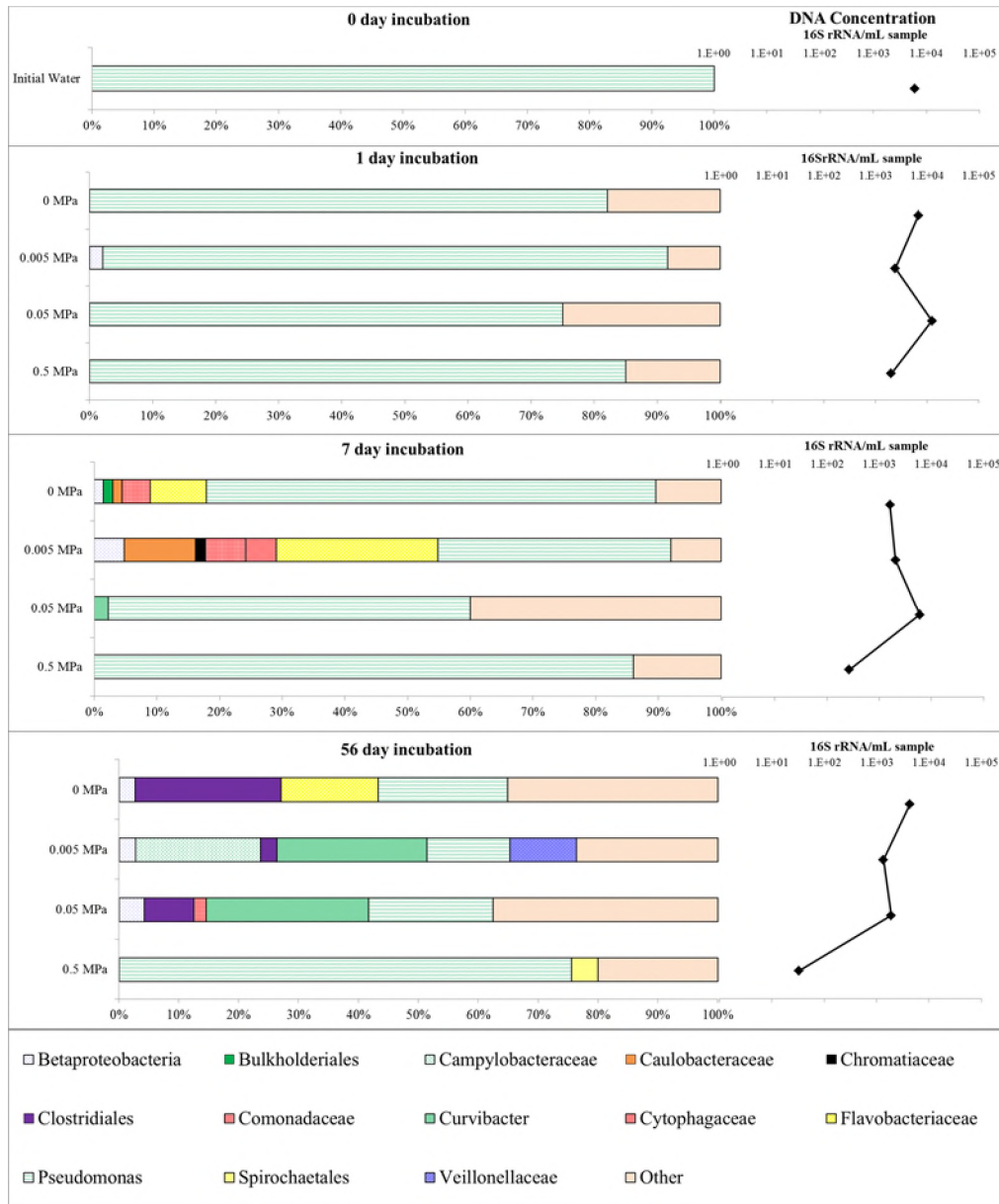
Despite numerous extraction procedures attempted, no DNA was detected utilizing qPCR procedures and PCR procedures for the reactor samples and the produced water filters. The lack of amplified DNA suggested the DNA concentrations to be too low to merit further microbial community analysis. PCR and qPCR analysis of a DNA-spiked produced water sample as a (positive control) from well 1060 suggested that little to no inhibition of DNA extraction procedures and PCR procedures was occurring.

Similar to the sample from East Seminole, it is unknown whether the low DNA concentration in Emma samples was due to a filtering process before fluid collection at the wellhead, or due to a low microbial population in the reservoir. Regardless, the DNA concentration of the Emma samples was too low for further microbial community analysis.

#### Plant Daniel Freshwater Aquifer

In order to understand the effect of CO<sub>2</sub> on microbial communities in a leakage scenario, the microbial community changes of samples from Plant Daniel freshwater aquifer with CO<sub>2</sub> exposure were investigated. Samples were placed in batch reactors with increasing pCO<sub>2</sub> (0, 0.005, 0.05, and 0.5 MPa) at reservoir total pressure (0.5 MPa) and temperature (22°C). Reactors were depressurized after 1 day, 7 days, and 56 days and the microbial community was analyzed with qPCR and 16S rRNA clone libraries.

Results from the microbial community analysis after 56 days of exposure are discussed in detail in Section 3.3. However, the microbial community was also characterized after 1 day and 7 days of CO<sub>2</sub> exposure (Figure 22). A dominant portion of the microbial community appeared to be represented by *Pseudomonas* after 1 day and 7 days for all pCO<sub>2</sub> exposures. However, after 56 days of CO<sub>2</sub> exposure, the microbial community appeared to be distinct for each pCO<sub>2</sub> exposure. This suggested that the microbial community had not yet adjusted to the pressure vessel conditions and to each CO<sub>2</sub> exposure after 1 day and 7 days. For this reason, results were only discussed for the 56 day pressure vessels, as this appeared to represent a more equilibrated microbial community.



**Figure 22: Relative proportions of phylotypes recovered from reactors exposing unfiltered Plant Daniel freshwater aquifer samples to increasing pCO<sub>2</sub> as revealed by 16S rRNA gene clone libraries and qPCR for a) initial drill stem test sample, and following b) 1 day of exposure, c) 7 days of exposure, and d) 56 days of exposure. Clones were assigned a genera based on >97% similarity to cultured organisms. Clones with less than 97% similarity were characterized as “other”. The inset shows the concentration of 16S rRNA genes recovered by qPCR for each sample for a given pCO<sub>2</sub> exposure. Concentrations of genes are reported as gene copies/mL of fluid sample.**



## **4. CONCLUSIONS**

### **4.1 CONCLUSIONS AND CONTRIBUTIONS**

The goal of this project was to characterize the change of microbial communities with CO<sub>2</sub> exposures that can be expected during carbon storage in a deep saline aquifer and a depleted oil reservoir, and resulting from CO<sub>2</sub> leakage into an overlying freshwater aquifer. It was hypothesized that CO<sub>2</sub> exposure in the subsurface would reduce both the microbial population numbers and diversity of subsurface microbial communities. The results from this project suggest that high CO<sub>2</sub> concentrations expected near the CO<sub>2</sub> injection plume or leakage plume will lead to a reduced microbial population, and that a unique site-specific microbial community is expected to arise at locations away from the CO<sub>2</sub> source where the CO<sub>2</sub> concentration is diminished.

This is one of few sets of experiments that characterize the change in microbial communities with increasing CO<sub>2</sub> concentrations using difficult to obtain subsurface samples. One major contribution of this project is a catalogue of microorganisms that appear to thrive in these poorly understood ecosystems. A second major contribution of this project is a direct comparison of the changes in the CO<sub>2</sub> exposed microbial communities from different but important subsurface samples representing three types of sites that may be impacted by CO<sub>2</sub> injection. Through this comparison, results suggest for the first time that the effect of CO<sub>2</sub> concentration on subsurface microbial communities is highly dependent on the resulting pH of the system. The comparison of the results also suggests the microbial communities that may emerge in CO<sub>2</sub> exposed environments will be site specific rather than predictable based solely on the geochemical conditions of the site.

### **4.2 IMPLICATIONS**

Microbial processes such as biofilm formation and biomineralization are currently being researched as a mitigation strategy for reducing the porosity of leakage pathways in carbon storage environments (Cunningham et al., 2009; Mitchell et al., 2010; Mitchell et al., 2009; Phillips et al., 2013). These studies currently utilize cultured experiments, and demonstrate that biofilm production and biomineralization may reduce reservoir porosity by up to 99% (Cunningham et al., 2009; Mitchell et al., 2010; Mitchell et al., 2009; Phillips et al., 2013). However, results from this project demonstrate CO<sub>2</sub> exposure will lead to a reduction of the microbial population regardless of the subsurface site and resulting pH, suggesting that microbial processes near the CO<sub>2</sub> injection plume or CO<sub>2</sub> leakage plume will be significantly hindered or absent. While the cultured environment demonstrates that microbial processes may be a viable solution to reducing leakage pathways, this study suggests that the microbial community is not likely to survive the CO<sub>2</sub> exposure near the plume, or where a leakage plume is likely to occur. An alternate mitigation method of leakage prevention will be needed at distances closest to the CO<sub>2</sub> plume.

The lethal effect of CO<sub>2</sub> on microbial communities demonstrated in this project has beneficial implications for the oil and gas industry. The oil and gas industry has long researched mitigation strategies to prevent biologically induced corrosion and biological hydrogen sulfide production (Gieg et al., 2011; Little and Jackson, 2010). The current mitigation strategy for these deleterious biological reactions is the utilization of chemical biocides or induced microbial competition, both of which have had limited success. The work in this project suggests that microbial growth in oil

reservoirs will be hindered with 1% pCO<sub>2</sub> exposure, and absent with 10% pCO<sub>2</sub> exposure. These results suggest CO<sub>2</sub> exposure, such as SC-CO<sub>2</sub> injection for EOR, may be an effective alternative mitigation strategy for deleterious microbial processes in the oil and gas industry.

This work utilized difficult to obtain subsurface samples, allowing a rare opportunity to characterize the microbial communities of currently poorly understood environmental microbial niches. The field of geomicrobiology currently researches these microbial niches which are often inhabited by unique microorganisms tolerant to harsh conditions such as low nutrient concentrations, high temperature, high pressure, and high salinity. Microbial communities that have evolved to adapt to these conditions may demonstrate the ability to become tolerant of other poorly understood niches, such as deep marine subsurface sediments. The microbial communities characterized in this project add to a catalogue of microbial communities characterized for subsurface environments, and may therefore improve understanding of adaptable, stress-tolerant microorganisms in the field of geomicrobiology.

### **4.3 FUTURE WORK**

The work in this project demonstrates the emerging microbial communities with CO<sub>2</sub> exposure to be unique to each site. This suggests that other types of carbon storage environments and impacted aquifers may not lead to the emergence of predictable microbial communities based on the research in this thesis. The three sites studied in this project may not yet be a sufficient number of sites to identify trends that may be applied to other types of carbon storage sites and impacted aquifers. Additional research may support the site dependent results of this project, implying the emerging microbial community of every new CO<sub>2</sub> exposed environment will need to be analyzed as unique. However, the inclusion of additional sites from these same types of reservoirs may demonstrate a trend in the emerging microbial communities of CO<sub>2</sub> exposed environments, which may then be applied to other carbon storage and CO<sub>2</sub> leakage sites. It remains to be seen if all saline sites, or all depleted oil reservoirs may behave more similarly to each other, than across sites types as studied here.

Once the emerging microbial community in CO<sub>2</sub> exposed environments has been characterized, future work should focus on understanding the metabolic pathways and secondary biproducts of these microorganisms. Laboratory experiments should utilize detailed geochemical analysis to measure the effect of CO<sub>2</sub> tolerant microbial communities on water chemistry properties, such as the rate of metal ion dissolution or rate of metal ion precipitation, in order to understand the biogeochemical processes of relevant biota for GCS or CO<sub>2</sub> leakage. This will increase understanding of how an altered microbial community may affect the biogeochemical processes post CO<sub>2</sub> injection or post CO<sub>2</sub> leakage.

The work presented in this project relies largely on laboratory based experimental results. While best efforts were made to simulate subsurface conditions, some conditions, such as the effect of rock matrix on pH, were not replicated. As subsurface carbon storage becomes a more common practice, opportunities to collect in situ water and rock samples of CO<sub>2</sub> exposed microbial communities may arise. Future increased availability of in situ water and sediment samples will also allow investigation of the effect of long-term CO<sub>2</sub> exposure on microbial communities, without the need to account for nutrient depletion or microbial product buildup that may occur in a reactor. Characterization of these in situ samples will further increase understanding of relevant microbial communities that will emerge post-CO<sub>2</sub> injection. This future work would compare changes in geochemistry, mineralogy, and microbiology of CO<sub>2</sub> exposed subsurface

sites. This would allow a detailed analysis of changes in biogeochemical properties that occur in carbon storage sites and impacted aquifers.

Although results from this project suggest each emerging microbial community will be site dependent, it is unknown whether the adaptable microorganisms among the sites shared a trend in functional genes. For example, the increasing CO<sub>2</sub> may have allowed the emergence of microorganisms that varied taxonomically, but were similar metabolically. A metagenomic analysis of the DNA isolated from each site would demonstrate if any trends in functional genes emerged with increasing CO<sub>2</sub> exposure. Metatranscriptomic analysis could also be utilized to detect the active functional genes; this would increase understanding microbial evolution with CO<sub>2</sub> exposure. Metagenomic and metatranscriptomic analysis of the emerging microbial communities in CO<sub>2</sub> exposed environments would also allow an investigation of potential metabolic products and secondary byproducts that may be produced during carbon storage or CO<sub>2</sub> leakage. These analyses will increase the understanding in microbial processes that may occur in carbon storage sites and CO<sub>2</sub> leakage sites, which may then increase understanding of how the emerging microbial communities will impact biogeochemical processes after CO<sub>2</sub> injection or CO<sub>2</sub> leakage.

This project suggests CO<sub>2</sub> exposure will result in a decrease in microbial population near the CO<sub>2</sub> injection plume. This result has practical significance to the oil and gas industry, as CO<sub>2</sub> exposure may reduce microbial communities causing biologically induced corrosion and H<sub>2</sub>S production. Investigation of the effect of increasing CO<sub>2</sub> exposure on microorganisms previously responsible for these deleterious biological processes, such as *Desulfovibrio*, *Desulfomonas*, and *Clostridia* (Gieg et al., 2011; Little and Jackson, 2010) would provide further evidence that CO<sub>2</sub> exposure may be an effective mitigation method for reducing biological corrosion and biological souring.

## 5. REFERENCES

- Altschul, S. F.; Gish, W.; Miller, W.; Myers, E. W.; Lipman, D. J. Basic local alignment search tools. *Journal of Molecular Biology* **1990**, *215*, 403–410.
- Amann, R. I.; Ludwig, W.; Schleifer, K. H. Phylogenetic identification and in-situ detection of individual microbial-cells without cultivation. *Microbiological Reviews* **1995**, *59*, 143–169.
- Amend, J. P.; Teske, A., Expanding frontiers in deep subsurface microbiology. *Palaeogeography Palaeoclimatology Palaeoecology* **2005**, *219*, 131–155.
- Arahal, D. R.; Vreeland, R. H.; Litchfield, C. D.; Mormile, M. R.; Tindall, B. J.; Oren, A.; Bejar, V.; Quesada, E.; Ventosa, A., Recommended minimal standards for describing new taxa of the family Halomonadaceae (vol 57, pg 2436, 2007). *International Journal of Systematic and Evolutionary Microbiology* **2008**, *58*, 2673–2673.
- Arrigo, K. R. Marine microorganisms and global nutrient cycles. *Nature* **2005**, *437*, 349–355.
- Basso, O.; Lascourreges, J. F.; Le Borgne, F.; Le Goff, C.; Magot, M. Characterization by culture and molecular analysis of the microbial diversity of a deep subsurface gas storage aquifer. *Research in Microbiology* **2009**, *160*, 107–116.
- Bates, S. T.; Berg-Lyons, D.; Caporaso, J. G.; Walters, W. A.; Knight, R.; Fierer, N. Examining the global distribution of dominant archaeal populations in soil. *Isme Journal* **2011**, *5*, 908–917.
- Bernardet, J. F.; Nakagawa, Y.; Holmes, B.; Subcommittee Taxonomy, F. Proposed minimal standards for describing new taxa of the family Flavobacteriaceae and emended description of the family. *International Journal of Systematic and Evolutionary Microbiology* **2002**, *52*, 1049–1070.
- Biddle, J. F.; House, C. H.; Brenchley, J. E. Microbial stratification in deeply buried marine sediment reflects changes in sulfate/methane profiles. *Geobiology* **2005**, *3*, 287–295.
- Bin, L.; Ye, C.; Lijun, Z.; Ruidong, Y. Effect of Microbial Weathering on Carbonate Rocks. *Earth Science Frontiers* **2008**, *15*.
- Borin, S.; Crotti, E.; Mapelli, F.; Tamagnini, I.; Corselli, C.; Daffonchio, D. DNA is preserved and maintains transforming potential after contact with brines of the deep anoxic hypersaline lakes of Eastern Mediterranean Sea. *Saline Systems* **2008**, *4*, 1–9.
- Cho, C.; Song, J. Xanthobacter sp. 1MCC1720 16S ribosomal RNA gene, partial sequence. **2013** <http://www.ncbi.nlm.nih.gov/nuccore/DQ664202.1?report=GenBank>
- Corstjens, P.; Muyzer, G. Phylogenetic analysis of the metal-oxidizing bacteria leptothrix-discophora and spaerotilus-natans using 16S rDNA sequencing data. *Systematic and Applied Microbiology* **1993**, *16*, 219–223.
- Costello, A. M.; Lidstrom, M. E. Molecular characterization of functional and phylogenetic genes from natural populations of methanotrophs in lake sediments. *Applied and Environmental Microbiology* **1999**, *65*, 5066–5074.
- Cui, Z. S.; Lai, Q. L.; Dong, C. M.; Shao, Z. Z. Biodiversity of polycyclic aromatic hydrocarbon-degrading bacteria from deep sea sediments of the Middle Atlantic Ridge. *Environmental Microbiology* **2008**, *10*, 2138–2149.
- Cunningham, A. B.; Gerlach, R.; Spangler, L.; Mitchell, A. C. Microbially Enhanced Geologic Containment of Sequestered Supercritical CO<sub>2</sub>. *Energy Procedia* **2009**, 3245–3252.

- Dafflon, B.; Wu, Y. X.; Hubbard, S. S.; Birkholzer, J. T.; Daley, T. M.; Pugh, J. D.; Peterson, J. E.; Trautz, R. C. Monitoring CO<sub>2</sub> Intrusion and Associated Geochemical Transformations in a Shallow Groundwater System Using Complex Electrical Methods. *Environmental Science & Technology* **2013**, *47*, 314–321.
- Delong, E. F., Archaea in coastal marine environments. *Proceedings of the National Academy of Sciences of the United States of America* **1992**, *89*, 5685–5689.
- D'Hondt, S.; Jorgensen, B. B.; Miller, D. J.; Batzke, A.; Blake, R.; Cragg, B. A.; Cypionka, H.; Dickens, G. R.; Ferdelman, T.; Hinrichs, K. U.; Holm, N. G.; Mitterer, R.; Spivack, A.; Wang, G. Z.; Bekins, B.; Engelen, B.; Ford, K.; Gettemy, G.; Rutherford, S. D.; Sass, H.; Skilbeck, C. G.; Aiello, I. W.; Guerin, G.; House, C. H.; Inagaki, F.; Meister, P.; Naehr, T.; Niitsuma, S.; Parkes, R. J.; Schippers, A.; Smith, D. C.; Teske, A.; Wiegand, J.; Padilla, C. N.; Acosta, J. L. S. Distributions of microbial activities in deep subseafloor sediments. *Science* **2004**, *306*, 2216–2221.
- Ding, L. X.; Yokota, A. Proposals of *Curvibacter gracilis* gen. nov., sp. nov. and *Herbaspirillum putei* sp. nov. for bacterial strains isolated from well water and reclassification of *Pseudomonas huttiensis*, *Pseudomonas lanceolata*, *Aquaspirillum delicatum* and *Aquaspirillum autotrophicum* as *Herbaspirillum huttiense* comb. nov., *Curvibacter lanceolatus* comb. nov., *Curvibacter delicatus* comb. nov. and *Herbaspirillum autotrophicum* comb. nov. *International Journal of Systematic and Evolutionary Microbiology* **2004**, *54*, 2223–2230.
- Edgar, R. C.; Haas, B. J.; Clemente, J. C.; Quince, C.; Knight, R. UCHIME improves sensitivity and speed of chimera detection. *Bioinformatics* **2011**, *27*, 2194–2200.
- Falcone-Dias, M. F.; Vaz-Moreira, I.; Manaia, C. M. Bottled mineral water as a potential source of antibiotic resistant bacteria. *Water Research* **2012**, *46*, 3612–3622.
- Fry, J. C.; Parkes, R. J.; Cragg, B. A.; Weightman, A. J.; Webster, G. Prokaryotic biodiversity and activity in the deep subseafloor biosphere. *Fems Microbiology Ecology* **2008**, *66*, 181–196.
- Gadd, G. M. Microbial influence on metal mobility and application for bioremediation. *Geoderma* **2004**, *122*, 109–119.
- Garcia-Dominguez, E.; Mumford, A.; Rhine, E. D.; Paschal, A.; Young, L. Y., Novel autotrophic arsenite-oxidizing bacteria isolated from soil and sediments. *Fems Microbiology Ecology* **2008**, *66*, 401–410.
- Gauthier, M. J.; Lafay, B.; Christen, R.; Fernandez, L.; Acquaviva, M.; Bonin, P.; Bertrand, J. C. *Marinobacter-hydrocarbonclasticus* gen.-nov., sp.-nov., a new, extremely halotolerant, hydrocarbon-degrading marine bacterium. *International Journal of Systematic Bacteriology* **1992**, *42*, 568–576.
- Gieg, L. M.; Jack, T. R.; Foght, J. M. Biological souring and mitigation in oil reservoirs. *Appl. Microbiol. Biotechnol.* **2011**, *92*, 263–282.
- Gill, C. O.; Tan, K. H. Effect of carbon dioxide on the growth of *Pseudomonas fluorescens*. *Applied and Environmental Microbiology* **1979**, *38*, 237–240.
- Goffredi, S. K.; Orphan, V. J. Bacterial community shifts in taxa and diversity in response to localized organic loading in the deep sea. *Environmental Microbiology* **2010**, *12*, 344–363.

- Gulliver, D. M.; Lowry, G. V.; Gregory, K. B. CO<sub>2</sub> concentration and pH alters subsurface microbial ecology at reservoir temperature and pressure. *RSC Advances* **2014**, *4*, 17443–17453.
- Hall-Stoodley, L.; Costerton, J. W.; Stoodley, P. Bacterial biofilms: From the natural environment to infectious diseases. *Nature Reviews Microbiology* **2004**, *2*, 95–108.
- Hamamura, N.; Fukushima, K.; Itai, T. Identification of antimony- and arsenic-oxidizing bacteria associated with antimony mine tailing. *Microbe Environment* **2013**, *28*, 257–263.
- Hino, S.; Watanabe, K.; Takahashi, N. Isolation and characterization of slime-producing bacteria capable of utilizing petroleum hydrocarbons as a sole carbon source. *Journal of Fermentation and Bioengineering* **1997**, *84*, 528–531.
- Holmes, D. E.; Bond, D. R.; O'Neill, R. A.; Reimers, C. E.; Tender, L. R.; Lovley, D. R. Microbial communities associated with electrodes harvesting electricity from a variety of aquatic sediments. *Microbial Ecology* **2004**, *48*, 178–190.
- Huber, J. A.; Butterfield, D. A.; Baross, J. A., Temporal changes in archaeal diversity and chemistry in a mid-ocean ridge seafloor habitat. *Applied and Environmental Microbiology* **2002**, *68*, 1585–1594.
- Huber, J. A.; Welch, D. B. M.; Morrison, H. G.; Huse, S. M.; Neal, P. R.; Butterfield, D. A.; Sogin, M. L. Microbial Population Structures in Deep Marine Biosphere. *Science* **2007**, *318*, 97–100.
- Huber, T.; Faulkner, G.; Hugenholtz, P. Bellerophon: a program to detect chimeric sequences in multiple sequence alignments. *Bioinformatics* **2004**, *20*, 2317–2319.
- Huu, N. B.; Denner, E. B. M.; Ha, D. T. C.; Wanner, G.; Stan-Lotter, H. *Marinobacter aquaeolei* sp. nov., a halophilic bacterium isolated from a Vietnamese oil-producing well. *International Journal of Systematic Bacteriology* **1999**, *49*, 367–375.
- IEA. Global status of CCS; International Energy Agency, 2011; pp 1–156.
- Inagaki, F.; Suzuki, M.; Takai, K.; Oida, H.; Sakamoto, T.; Aoki, K.; Nealson, K. H.; Horikoshi, K. Microbial communities associated with geological horizons in coastal seafloor sediments from the Sea of Okhotsk. *Applied and Environmental Microbiology* **2003**, *69*, 7224–7235.
- Ishii, S.; Sadowsky, M. J. *Escherichia coli* in the environment: Implications for water quality and human health. *Microbes and Environments* **2008**, *23*, 101–108.
- Jackson, C.; Scheffer, A.; Fowle, D.; Watney, L. W.; Strazisar, B.; Roberts, J. A. Geochemical and microbiological influence on seal integrity during SC-CO<sub>2</sub> exposure, Arbuckle aquifer, SE Kansas. Geological Society of America Charlotte, NC; Geological Society of America Abstracts with Programs: Charlotte, NC, 2012; p 109.
- Kashefi, K.; Lovley, D. R. Extending the upper temperature limit for life. *Science* **2003**, *301*, 934–934.
- Kazuba, J. P.; Janeky, D. R.; Snow, M. G. Carbon dioxide reaction processes in a model brine aquifer at 200 C and 200 bar: implications for geologic sequestration of carbon. *Applied Geochemistry* **2003**, *18*, 1065–1080.
- Kharaka, Y. K.; Thordsen, J. J.; Hovorka, S. D.; Nance, H. S.; Cole, D. R.; Phelps, T. J.; Knauss, K. G. Geochemical results from the Frio-I Brine Pilot test, Texas, USA. In *Potential environmental issues of CO<sub>2</sub> storage in deep saline aquifers*; 2009; pp 1106–1112.

- Kurr, M.; Huber, R.; Konig, H.; Jannasch, H. W.; Fricke, H.; Trincone, A.; Kristjansson, J. K.; Stetter, K. O., Methanopyrus-kanleri, gen and sp-nov represents a novel group of hyperthermophilic methanogens, growing at 110 degrees C. *Archives of Microbiology* **1991**, *156*, 239–247.
- Kutchko, B. G.; Strazisar, B. R.; Dzombak, D. A.; Lowry, G. V.; Thaulow, N., Degradation of well cement by CO<sub>2</sub> under geologic sequestration conditions. *Environmental Science & Technology* **2007**, *41*, 4787–4792.
- Lalucat, J.; Bennisar, A.; Bosch, R.; Garcia-Valdes, E.; Palleroni, N. J. Biology of *Pseudomonas stutzeri*. *Microbiology and Molecular Biology Reviews* **2006**, *70*, 510.
- Lane, D. J.; Pace, B.; Olsen, G. J.; Stahl, D. A.; Sogin, M. L.; Pace, N. R. Rapid-determination of 16S ribosomal-RNA sequences for phylogenetic analyses. *Proceedings of the National Academy of Sciences of the United States of America* **1985**, *82*, 6955–6959.
- Lane, D., 16S/23S rRNA sequencing. In *Nucleic Acid Techniques in Bacterial Systematics*; Stackebrandt, E.; Goodfellow, M., Eds.; Wiley: Chichester, England, 1991; pp 115-175.
- Lee, J.-W.; Kwon, K. K.; Azizi, A.; Oh, H.-M.; Kim, W.; Bahk, J.-J.; Lee, D.-H.; Lee, J.-H. Microbial community structures of methane hydrate-bearing sediments in the Ulleung Basin, East Sea of Korea. *Marine and Petroleum Geology* **2013**, *47*, 136–146.
- Leu, J. Y.; McGovern-Traa, C. P.; Porter, A. J. R.; Harris, W. J.; Hamilton, W. A. Identification and phylogenetic analysis of thermophilic sulfate-reducing bacteria in oil field samples by 16S rDNA gene cloning and sequencing. *Anaerobe* **1998**, *4*, 165–174.
- Li, D.; Midgley, D. J.; Ross, J. P.; Oytam, Y.; Abell, G. C. J.; Volk, H.; Daud, W. a. W.; Hendry, P. Microbial biodiversity in a Malaysian oil field and a systematic comparison with oil reservoirs worldwide. *Archives of Microbiology* **2012**, *194*, 513–523.
- Little, M. G.; Jackson, R. B., Potential Impacts of Leakage from Deep CO<sub>2</sub> Geosequestration on Overlying Freshwater Aquifers. *Environmental Science & Technology* **2010**, *44*, 9225–9232.
- Ma, Y.; Galinski, E. A.; Grant, W. D.; Oren, A.; Ventosa, A. Halophiles 2010: Life in Saline Environments. *Applied Environmental Microbiology* **2010**, 6971–6981.
- Madigan, M. T.; Martinko, J. T.; Dunlap, P. V.; Clark, D. P. *Brock Biology of Microorganisms*, 12th ed.; 2008.
- Magot, M.; Ollivier, B.; Patel, B. K. C. Microbiology of petroleum reservoirs. *Antonie Van Leeuwenhoek International Journal of General and Molecular Microbiology* **2000**, *77*, 103–116.
- Meehl, G. A.; Zwiers, F.; Evans, J.; Knutson, T.; Mearns, L.; Whetton, P. Trends in extreme weather and climate events: Issues related to modeling extremes in projections of future climate change. *Bulletin of the American Meteorological Society* **2000**, *81*, 427–436.
- Mitchell, A. C.; Dideriksen, K.; Spangler, L. H.; Cunningham, A. B.; Gerlach, R. Microbially Enhanced Carbon Capture and Storage by Mineral-Trapping and Solubility-Trapping. *Environmental Science & Technology* **2010**, *44*, 5270–5276.
- Mitchell, A. C.; Phillips, A. J.; Hiebert, R.; Gerlach, R.; Spangler, L. H.; Cunningham, A. B. Biofilm enhanced geologic sequestration of supercritical CO<sub>2</sub>. *Int. J. Greenh. Gas Control* **2009**, *3*, 90–99.

- Moller, B.; Ossmer, R.; Howard, B. H.; Gottschalk, G.; Hippe, H. Sporomusa, a new genus of gram-negative anaerobic bacteria including sporomusa-sphaeroides spec-nov and sporomusa-ovata spec-nov. *Archives of Microbiology* **1984**, *139*, 388–396.
- Motamedi, M.; Pedersen, K. Desulfovibrio aespoensis sp. nov., a mesophilic sulfate-reducing bacterium from deep groundwater at Aspo hard rock laboratory, Sweden. *International Journal of Systematic Bacteriology* **1998**, *48*, 311–315.
- Naganuma, T.; Yukimura, K.; Todaka, N.; Ajima, S. Concept and experimental study for a new enhanced mineral trapping system by means of microbially mediated processes. *Energy Procedia* **2011**, *4*, 5079–5084.
- Okamoto, T.; Maruyama, A.; Imura, S.; Takeyama, H.; Naganuma, T. Comparative phylogenetic analyses of Halomonas variabilis and related organisms based on sequences 16S rRNA, gyrB and ectBC gene sequences. *Systematic and Applied Microbiology* **2004**, *27*, 323–333.
- Orphan, V. J.; Taylor, L. T.; Hafenbradl, D.; Delong, E. F. Culture-dependent and culture-independent characterization of microbial assemblages associated with high-temperature petroleum reservoirs. *Applied and Environmental Microbiology* **2000**, *66*, 700–711.
- Paredes-Sabja, D.; Setlow, P.; Sarker, M. R. Germination of spores of Bacillales and Clostridiales species: mechanisms and proteins involved. *Trends in Microbiology* **2011**, *19*, 85–94.
- Park, J.; Sanford, R. A.; Bethke, C. M. Microbial activity and chemical weathering in the Middendorf aquifer, South Carolina. *Chemical Geology* **2009**, *258*, 232–241.
- Parkes, R. J.; Cragg, B. A.; Bale, S. J.; Getliff, J. M.; Goodman, K.; Rochelle, P. A.; Fry, J. C.; Weightman, A. J.; Harvey, S. M. Deep Bacterial Biosphere in Pacific-Ocean Sediments. *Nature* **1994**, *371*, 410–413.
- Peix, A.; Ramirez-Bahena, M. H.; Velazquez, E. Historical evolution and current status of the taxonomy of genus Pseudomonas. *Infection Genetics and Evolution* **2009**, *9*, 1132–1147.
- Phillips, A. J.; Lauchnor, E.; Eldring, J.; Esposito, R.; Mitchell, A. C.; Gerlach, R.; Cunningham, A. B.; Spangler, L. H. Potential CO<sub>2</sub> Leakage Reduction through Biofilm-Induced Calcium Carbonate Precipitation. *Environmental Science & Technology* **2013**, *47*, 142–149.
- Rackley, S. A. *Carbon Capture and Storage*; Elsevier, 2009.
- Raskin, L.; StromLey, J. M.; Rittmann, B. E.; Stahl, D. A. Group-specific 16S ribosomal RNA hybridization probes to describe natural communities of methanogens. *Applied and Environmental Microbiology* **1994**, *60*, 1232–1240.
- Ren, H. Y.; Zhang, X. J.; Song, Z. Y.; Rupert, W.; Gao, G. J.; Guo, S. X.; Zhao, L. P. Comparison of Microbial Community Compositions of Injection and Production Well Samples in a Long-Term Water-Flooded Petroleum Reservoir. *Plos One* **2011**, *6*, 1–9.
- Reysenbach, A.; Pace, N. Thermophiles. In *Archaea: A laboratory manual*; Robb, F.; Place, A., Eds.; Cold Spring Harbour Laboratory Press: New York, USA, 1995; pp 101–107.
- Rickard, A. H.; McBain, A. J.; Ledder, R. G.; Handley, P. S.; Gilbert, P. Coaggregation between freshwater bacteria within biofilm and planktonic communities. *Fems Microbiol Lett* **2003**, *220*, 133–140.



- Ridgway, H. F.; Safarik, J.; Phipps, D.; Carl, P.; Clark, D. Identification and catabolic activity of well-derived gasoline-degrading bacteria from a contaminated aquifer. *Applied and Environmental Microbiology* **1990**, *56*, 3565–3575.
- Rivadeneira, M. A.; Delgado, R.; Parraga, J.; Ramos-Cormenzana, A.; Delgado, G. Precipitation of minerals by 22 species of moderately halophilic bacteria in artificial marine salts media: Influence of salt concentration. *Folia Microbiologica* **2006**, *51*, 445–453.
- Sanchez-Roman, M.; Rivadeneira, M. A.; Vasconcelos, C.; McKenzie, J. A., Biomineralization of carbonate and phosphate by moderately halophilic bacteria. *Fems Microbiology Ecology* **2007**, *61*, 273–284.
- Sardesai, Y.; Bhosle, S., Tolerance of bacteria to organic solvents. *Research in Microbiology* **2002**, *153*, 263–268.
- Satpute, S. K.; Banat, I. M.; Dhakephalkar, P. K.; Banpurkar, A. G.; Chopade, B. A. Biosurfactants, bioemulsifiers, and exopolysaccharides from marine microorganisms. *Biotechnology Advances* **2010**, *28*, 436–450.
- Schloss, P. D.; Westcott, S. L.; Ryabin, T.; Hall, J. R.; Hartmann, M.; Hollister, E. B.; Lesniewski, R. A.; Oakley, B. B.; Parks, D. H.; Robinson, C. J.; Sahl, J. W.; Stres, B.; Thallinger, G. G.; Van Horn, D. J.; Weber, C. F. Introducing mothur: Open-Source, Platform-Independent, Community-Supported Software for Describing and Comparing Microbial Communities. *Applied and Environmental Microbiology* **2009**, *75*, 7537–7541.
- Schulz, A.; Vogt, C.; Richnow, H. H. Effects of high CO<sub>2</sub> concentrations on ecophysiological different microorganisms. *Environmental Pollution* **2012**, *169*, 27–34.
- Shah, A. H.; Saleha, A. A.; Zunita, Z.; Cheah, Y. K.; Murugaiyah, M.; Korejo, N. A. Genetic characterization of *Arcobacter* isolates from various sources. *Veterinary Microbiology* **2012**, *160*, 355–361.
- Smyth, R. C.; Hovorka, S. D.; Lu, J. M.; Romanak, K. D.; Partin, J. W.; Wong, C.; Yang, C. B. Assessing risk to fresh water resources from long term CO<sub>2</sub> injection - laboratory and field studies. *Greenhouse Gas Control Technologies* **2009**, *1*, 1957–1964.
- Spring, S.; Schulze, R.; Overmann, J.; Schleifer, K. H. Identification and characterization of ecologically significant prokaryotes in the sediment of freshwater lakes: molecular and cultivation studies. *Fems Microbiology Reviews* **2000**, *24*, 573–590.
- Steven, B.; Chen, M. O.; Greer, C. W.; Whyte, L. G.; Niederberger, T. D. *Tumebacillus permanentifrigoris* gen. nov., sp nov., an aerobic, spore-forming bacterium isolated from Canadian high Arctic permafrost. *International Journal of Systematic and Evolutionary Microbiology* **2008**, *58*, 1497–1501.
- Suzuki, M. T.; Taylor, L. T.; DeLong, E. F. Quantitative analysis of small-subunit rRNA genes in mixed microbial populations via 5'-nuclease assays. *Applied and Environmental Microbiology* **2000**, *66*, 4605–4614.
- Tan, Z.; Hurek, T.; Reinhold-Hurek, B. Beta proteobacterium Rufe9b 16S ribosomal RNA gene, partial sequence, 2003.  
[http://www.ncbi.nlm.nih.gov/nucleotide/37926820?report=genbank&log\\$=nucltop&blast\\_rank=1&RID=9X3YXAV701R](http://www.ncbi.nlm.nih.gov/nucleotide/37926820?report=genbank&log$=nucltop&blast_rank=1&RID=9X3YXAV701R)
- Team, R. D. C. *A language and environment for statistical computing*, R Foundation for Statistical Computing: Vienna, Austria, 2008.

- Trautz, R. C.; Pugh, J. D.; Varadharajan, C.; Zheng, L. G.; Bianchi, M.; Nico, P. S.; Spycher, N. F.; Newell, D. L.; Esposito, R. A.; Wu, Y. X.; Dafflon, B.; Hubbard, S. S.; Birkholzer, J. T. Effect of Dissolved CO<sub>2</sub> on a Shallow Groundwater System: A Controlled Release Field Experiment. *Environmental Science & Technology* **2013**, *47*, 298–305.
- van der Wielen, P.; Bolhuis, H.; Borin, S.; Daffonchio, D.; Corselli, C.; Giuliano, L.; D'Auria, G.; de Lange, G. J.; Huebner, A.; Varnavas, S. P.; Thomson, J.; Tamburini, C.; Marty, D.; McGenity, T. J.; Timmis, K. N.; BioDeep Sci, P. The enigma of prokaryotic life in deep hypersaline anoxic basins. *Science* **2005**, *307*, 121–123.
- vanden Hoven, R. N.; Santini, J. M. Arsenite oxidation by the heterotroph *Hydrogenophaga* sp. str. NT-14: the arsenite oxidase and its physiological electron acceptor. *Biochimica Et Biophysica Acta-Bioenergetics* **2004**, *1656*, 148–155.
- Vlasceanu, L.; Popa, R.; Kinkle, B. K., Characterization of *Thiobacillus thioparus* LV43 and its distribution in a chemoautotrophically based groundwater ecosystem. *Applied and Environmental Microbiology* **1997**, *63*, 3123–3127.
- Vollrath, S.; Behrends, T.; Koch, C. B.; Van Cappellen, P. Effects of temperature on rates and mineral products of microbial Fe(II) oxidation by *Leptothrix cholodnii* at microaerobic conditions. *Geochimica Et Cosmochimica Acta* **2013**, *108*, 107–124.
- Wang, Q.; Xie, N.; Qin, Y.; Shen, N.; Zhu, J.; Mi, H.; Huang, R. *Tumebacillus flagellatus* sp. nov., an alpha-amylase/pullulanase-producing bacterium isolated from cassava wastewater. *International Journal of Systematic and Evolutionary Microbiology* **2013**, *63*, 3138–3142.
- Warscheid, T.; Braams, J. Biodeterioration of stone: a review. *International Biodeterioration & Biodegradation* **2000**, *46*, 343–368.
- Watnick, P.; Kolter, R. Biofilm, city of microbes. *Journal of Bacteriology* **2000**, *182*, 2675–2679.
- Yakimov, M. M.; Timmis, K. N.; Golyshin, P. N. Obligate oil-degrading marine bacteria. *Current Opinion in Biotechnology* **2007**, *18*, 257–266.
- Yue, J.; Clayton, M. A similarity measure based on species proportions. *Communications in Statistics* **2005**, *34*, 2123–2131
- Zhang, J.; Davis, T.; Matthews, M.; Drews, M.; LaBerge, M.; An, Y. Sterilization using high-pressure carbon dioxide. *J. Supercrit. Fluids* **2006**, *38*, 354–372.

## **APPENDIX A: Supplementary Tables**

The following tables provide geochemical data for the Arbuckle saline aquifer (Table A.1), the Mirando oil reservoir (Table A.3), and the Plant Daniel freshwater aquifer (Table A.4). Additionally, the Good's coverage is given for the Arbuckle saline aquifer analyzes (Table A.2).

**Table A.1: Elements and selected anions measured in the reactors with the sample from Arbuckle saline aquifer after 56 days of exposure to 0 MPa, 0.1 MPa, 1.4 MPa, and 14 MPa pCO<sub>2</sub>. pH was modelled with the initial alkalinity of 388 mg/L as HCO<sub>3</sub><sup>-</sup>. <DL = below detection limit**

	Units	Initial	0 MPa pCO <sub>2</sub>	0.1 MPa pCO <sub>2</sub>	1.4 MPa pCO <sub>2</sub>	14 MPa pCO <sub>2</sub>
Ca	mg/L	2,502	2,071.0	2,186.0	2,186.0	2,104.0
Fe	mg/L	nd	nd	nd	0.5	2.5
K	mg/L	259	251.7	255.9	253.2	256.6
Mg	mg/L	702	567.8	578.4	577.1	590.7
Mn	mg/L	0.9	0.7	0.9	0.9	0.9
Na	mg/L	22,690	18,280.0	18,440.0	17,530.0	17,640.0
P	mg/L	1.5	3.4	1.4	2.4	2.0
S	mg/L	631	593.9	618.4	601.0	613.1
Si	mg/L	10	9.4	10.1	10.8	11.0
Zn	mg/L	0.2	0.1	0.8	1.8	2.4
Cl	mg/L	31,528	31,992.3	32,397.2	31,639.1	37,757.3
SO <sub>4</sub>	mg/L	1,190	369.9	1,007.4	953.7	1,096.3
TOC	mg/L	2,333.3	--	--	--	--
Alkalinity	Mg CaCO <sub>3</sub> /L	607	--	--	--	--
Modeled pH		7.8	7.50	5.50	4.38	2.88

**Table A.2: Good's coverage of 1 day, 7 day, and 56 day Arbuckle saline aquifer incubations for 0 MPa, 0.1 MPa, 1.4 MPa, and 14 MPa pCO<sub>2</sub> exposures. Good's coverage was calculated in Mothur (Schloss, 2009). Values indicate sufficient coverage given the very low diversity in the samples.**

	1 day	7 days	56 days
0 MPa CO <sub>2</sub>	0.68	0.88	0.83
0.1 MPa CO <sub>2</sub>	0.58	0.86	0.87
1.4 MPa CO <sub>2</sub>	0.67	0.81	0.85
14 MPa CO <sub>2</sub>	0.73	0.90	N/A

**Table A.3: Elements, anions, total organic carbon (TOC), alkalinity, and modeled pH in the reactors with samples from the Mirando oil reservoir after 56 days of exposure to 0 MPa, 0.03 MPa, 0.34 MPa, and 3.4 MPa pCO<sub>2</sub>. “nd” = non-detect**

	Units	Initial	0 MPa pCO <sub>2</sub>	0.03 MPa pCO <sub>2</sub>	0.34 MPa pCO <sub>2</sub>	3.4 MPa pCO <sub>2</sub>	0.34 MPa pCO <sub>2</sub> w/ CaCO <sub>3</sub>
Ca	mg/L	23.8	19.5	27.1	59.5	14.9	63.2
Fe	mg/L	nd	0.015	0.024	nd	nd	nd
K	mg/L	52.5	22.5	20.9	20.8	20.9	15.5
Mg	mg/L	nd	11.2	10.7	10.7	10.6	11.2
Mn	mg/L	nd	0.03	0.01	0.24	nd	nd
Na	mg/L	3,888	4,030	3,803	3,789	3,816	3,888
P	mg/L	nd	0.03	nd	0.03	0.02	nd
S	mg/L	nd	0.63	0.53	1.96	0.70	nd
Si	mg/L	24.54	24.46	24.18	25.02	25.00	26.50
Zn	mg/L	nd	nd	nd	nd	nd	0.068
F	mg/L	nd	1.2	1.2	1	1	nd
Cl	mg/L	6,596	6,563	6,325	6,233	6,283	6,766
SO <sub>4</sub>	mg/L	nd	nd	nd	5.8	nd	nd
Br	mg/L	18	17.9	17.5	17	17.1	18
TOC	mg/L	238	2,381	2,238	2,280	1,629	951
Alkalinity	Mg CaCO <sub>3</sub> /L	1,247	1,154	1,233	1,225	1,241	1,467
Modeled pH		8.42	8.42	6.44	5.40	4.34	5.80

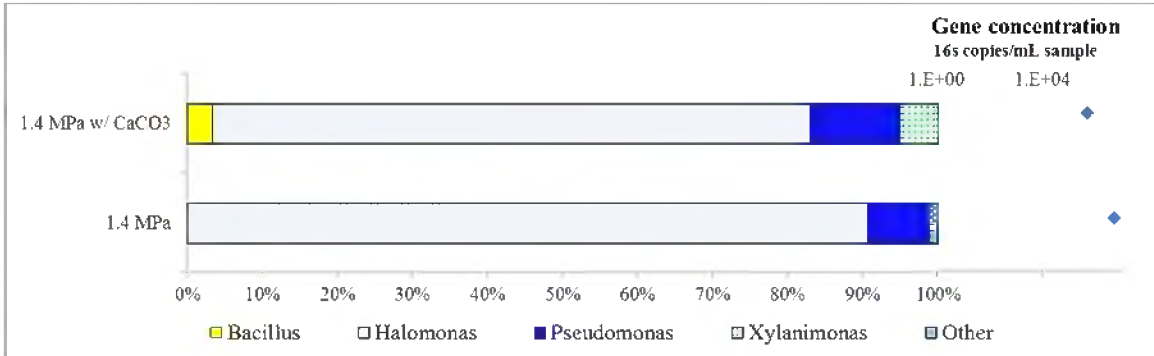
**Table A.4: Elements and anions measured in the reactor with sample from Plant Daniel freshwater aquifer after 56 days of exposure to 0 MPa, 0.005 MPa, 0.05 MPa, and 0.5 MPa pCO<sub>2</sub>.**

	Units	Initial	0 MPa pCO <sub>2</sub>	0.005 MPa pCO <sub>2</sub>	0.05 MPa pCO <sub>2</sub>	0.5 MPa pCO <sub>2</sub>	0.05 MPa pCO <sub>2</sub> w/ CaCO <sub>3</sub>
Ca	mg/L	2.9	2.9	2.9	2.9	3.0	350.6
Fe	mg/L	0.25	1.0	2.5	2.0	2.3	1.0
K	mg/L	8.2	7.5	7.4	7.5	7.5	9.0
Mg	mg/L	0.9	1.0	1.0	1.0	1.0	nd
Mn	mg/L	0.1	0.1	0.1	0.1	0.1	0.0
Na	mg/L	168	161.3	160.3	164.1	161.9	200.4
P	mg/L	0.1	0.1	0.1	0.1	0.1	nd
S	mg/L	nd	0.0	0.0	0.0	0.0	7.3
Si	mg/L	9.6	19.6	19.6	19.3	19.6	33.4
Zn	mg/L	nd	nd	nd	nd	nd	0.3
F	mg/L	nd	19.5	26.2	1.4	0.7	nd
Cl	mg/L	46	36.2	36.7	43.7	37.0	58.0
SO <sub>4</sub>	mg/L	17	IC	IC	IC	IC	nd
Br	mg/L	nd	IC	IC	IC	IC	nd
TOC	mg/L		12.6	22.7	21.3	47.9	
Alkalinity	Mg CaCO <sub>3</sub> /L	291.8	--	--	--	--	--
Modeled pH		8.2	8	6.77	5.8	4.8	6.4

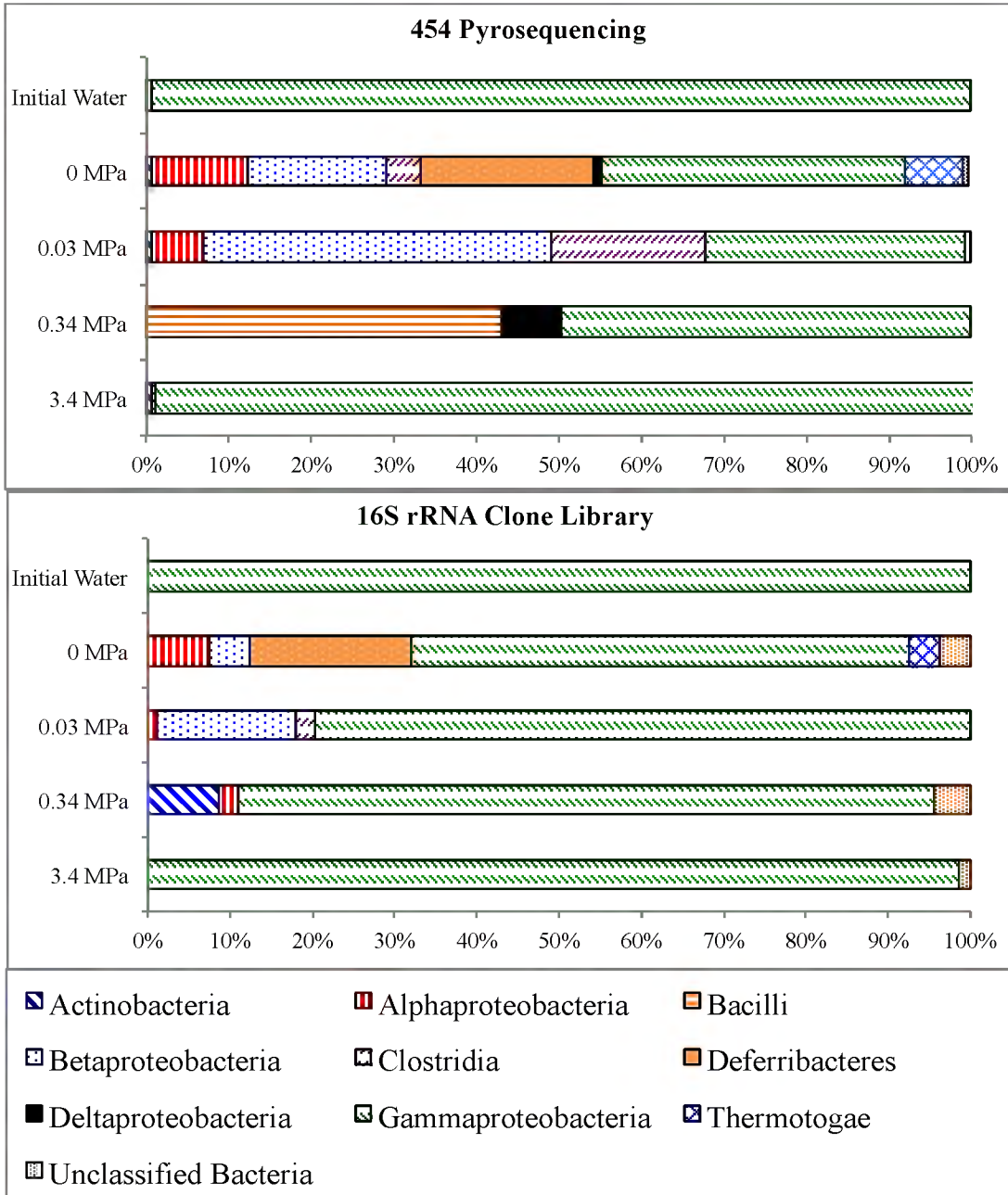
This page intentionally left blank.

**APPENDIX B: Supplementary Figures**

The following figures display microbial community data not discussed at length in the article. Data for buffered reactor of the Arbuckle saline aquifer is given in Figure B.1.

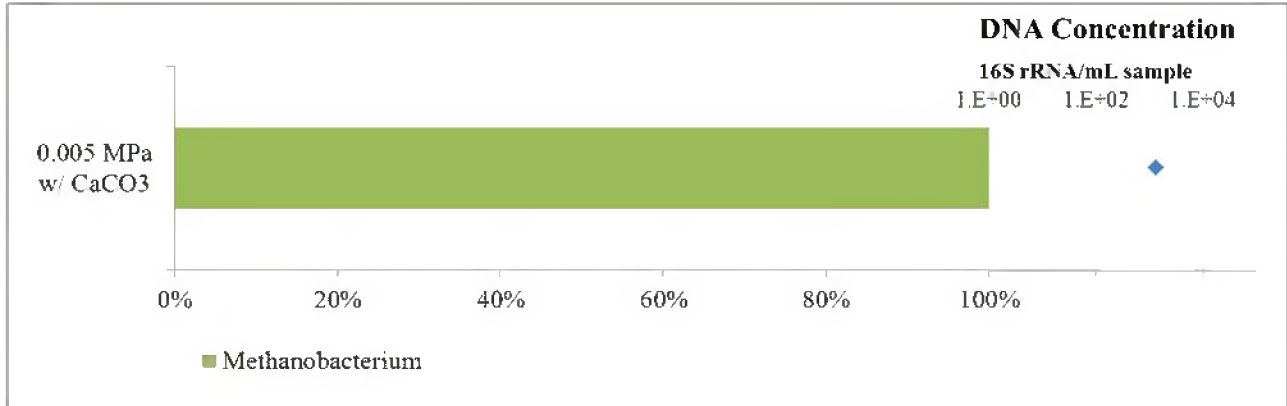


**Figure B.1:** In order to better understand the effect of buffering on the CO<sub>2</sub>-exposed microbial ecology, two additional reactors were pressurized for 7 days with 1.4 MPa CO<sub>2</sub>; one reactor only contained initial sample and one reactor contained initial sample with 1 g/L CaCO<sub>3</sub>. The non-buffered reactor was modelled to have a pH of 4.4, and the buffered reactor was modelled to have a pH of 5.0. However, the initial sample used for these experiments had a long hold time (over 1.5 years) in the 4°C refrigerator. For this reason, this stored initial water must be discussed as a different sample, as the initial microbial ecology had changed during the hold time. The effect of CO<sub>2</sub> exposure was similar in the absence and presence of calcite to buffer against pH shifts. The absence of *Marinobacter* in these two experiments is assumed to be due to the storage time of the initial sample. The diversity appeared decreased compared to the initial sample in both reactors. Communities from both reactors were overwhelmingly *Halomonas*. Gene concentration was similar between reactors.

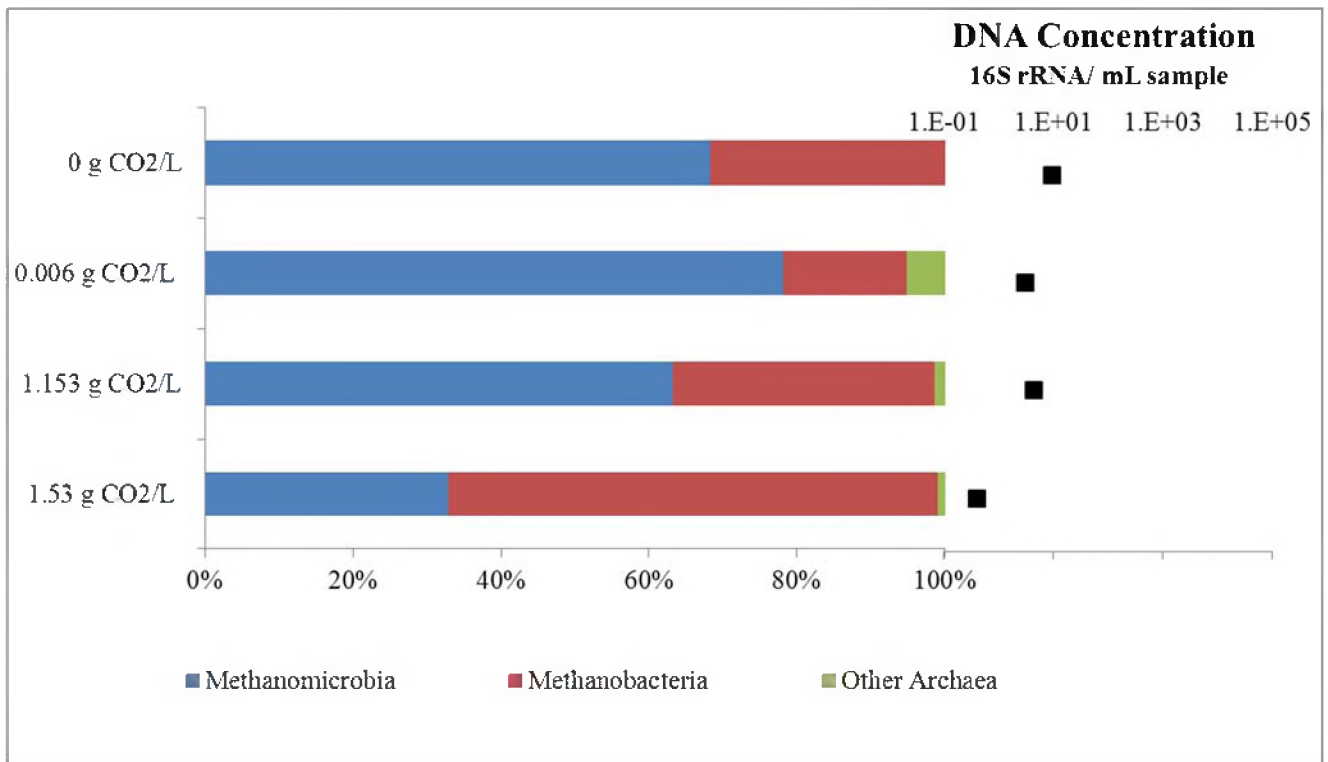


**Figure B.2: Comparison of 16S rRNA gene clone libraries and 454 pyrosequencing of relative proportions of phylotypes recovered from reactors exposing unfiltered produced water samples to increasing pCO<sub>2</sub> for 56 days. OTUs were assigned an order based on >97% similarity to cultured organisms. Clones with less than 97% similarity were characterized as “unclassified bacteria”.**





**Figure B.3: Microbial ecology of Archaea characterized by 16S rRNA gene clone libraries and microbial population quantified by qPCR methods. Archaea was only detectable for 0.05 MPa pCO<sub>2</sub> with CaCO<sub>3</sub> buffer after 56 days of incubation. Clones were assigned a genera based on >97% similarity to cultured organisms. Clones with less than 97% similarity were characterized as “other”.**



**Figure B.4: Relative proportions of Archaea recovered from unfiltered well samples downgradient of CO<sub>2</sub>-saturated-water injection well. Dissolved CO<sub>2</sub> of each well was measured by CarboQC and microbial community was revealed by 454 pyrosequencing and qPCR.**

This page intentionally left blank.





**Sean Plasynski**  
Executive Director  
Technology Development & Integration  
Center  
National Energy Technology Laboratory  
U.S. Department of Energy

**Cynthia Powell**  
Executive Director  
Research & Innovation Center  
National Energy Technology Laboratory  
U.S. Department of Energy

**John Wimer**  
Associate Director  
Strategic Planning  
Science & Technology Strategic Plans  
& Programs  
National Energy Technology Laboratory  
U.S. Department of Energy

**Traci Rodosta**  
Strategic Planning  
Science & Technology Strategic Plans  
& Programs  
National Energy Technology Laboratory  
U.S. Department of Energy

**Mark Ackiewicz**  
Director  
Division of Carbon Capture and Storage  
Office of Fossil Energy  
U.S. Department of Energy