



Pacific Northwest
NATIONAL LABORATORY

Proudly Operated by Battelle Since 1965

Stack Flow Rate Changes and the ANSI/N13.1-1999 Qualification Criteria: Application to the Hanford Canister Storage Building Stack

February 2016

JE Flaherty
JA Glissmeyer

DISCLAIMER

This report was prepared as an account of work sponsored by an agency of the United States Government. Neither the United States Government nor any agency thereof, nor Battelle Memorial Institute, nor any of their employees, makes **any warranty, express or implied, or assumes any legal liability or responsibility for the accuracy, completeness, or usefulness of any information, apparatus, product, or process disclosed, or represents that its use would not infringe privately owned rights.** Reference herein to any specific commercial product, process, or service by trade name, trademark, manufacturer, or otherwise does not necessarily constitute or imply its endorsement, recommendation, or favoring by the United States Government or any agency thereof, or Battelle Memorial Institute. The views and opinions of authors expressed herein do not necessarily state or reflect those of the United States Government or any agency thereof.

PACIFIC NORTHWEST NATIONAL LABORATORY

operated by

BATTELLE

for the

UNITED STATES DEPARTMENT OF ENERGY

under Contract DE-AC05-76RL01830

Printed in the United States of America

Available to DOE and DOE contractors from the
Office of Scientific and Technical Information,
P.O. Box 62, Oak Ridge, TN 37831-0062;
ph: (865) 576-8401
fax: (865) 576-5728
email: reports@adonis.osti.gov

Available to the public from the National Technical Information Service
5301 Shawnee Rd., Alexandria, VA 22312
ph: (800) 553-NTIS (6847)
email: orders@ntis.gov <<http://www.ntis.gov/about/form.aspx>>
Online ordering: <http://www.ntis.gov>



This document was printed on recycled paper.

(8/2010)

Stack Flow Rate Changes and the ANSI/N13.1-1999 Qualification Criteria: Application to the Hanford Canister Storage Building Stack

JE Flaherty
JA Glissmeyer

February 2016

Prepared for
the U.S. Department of Energy
under Contract DE-AC05-76RL01830

Pacific Northwest National Laboratory
Richland, Washington 99352

Summary

The Canister Storage Building (CSB), located in the 200-East Area of the Hanford Site, is a 42,000 square foot facility used to store spent nuclear fuel from past activities at the Hanford Site. Because the facility has the potential to emit radionuclides into the environment, its ventilation exhaust stack has been equipped with an air monitoring system. Subpart H of the National Emissions Standards for Hazardous Air Pollutants requires that a sampling probe be located in the exhaust stack in accordance with criteria established by the American National Standards Institute/Health Physics Society Standard N13.1-1999, *Sampling and Monitoring Releases of Airborne Radioactive Substances from the Stack and Ducts of Nuclear Facilities*.¹

The ability of the sampling probe location to meet the monitoring standard was demonstrated with a series of tests conducted on the stack itself in 1998. The tests were performed for the then-current stack flow rates. While the stack flow rates during these tests were primarily between 9000 and 10,000 cubic feet per minute (cfm), the facility has since operated at lower stack flow rates of around 8000 cfm. The purpose of this report is to present qualification test results from comparable stacks used to evaluate the impact of reduced flow rate on the qualification of the CSB stack sampling location.

Stack qualification test results from four stacks that are geometrically similar to the CSB stack were examined to evaluate the impact of reduced stack flow rate. The test data show that there is often a small slope to the fit line between the velocity of the test and the test result (percent coefficient of variation or degrees). For the CSB stack, it appears that the velocity could be reduced by 1000 feet per minute (fpm) without significant impact on the uniformity of velocity or gaseous tracer. Particulate tracer uniformity may be affected more significantly, but the uniformity is expected to improve with reduced velocity. In addition, the flow angle is not expected to change appreciably with stack velocities lowered by 1000 fpm. Therefore, for all of the qualification test types, it appears that, relative to the maximum tested flow rate, a 50% reduction in flow rate (or 1000 fpm reduction in velocity) would result in tests results that fall within criteria limits.

¹ The standard has been reaffirmed in 2011 and is identical to the 1999 version. The regulations have not been updated, so the 1999 version is still referenced.

Acknowledgments

We acknowledge the efforts of Carmen Arimescu in compiling the test results used in this report and Ernest Antonio in providing a peer review. In addition, project specialist Ginny Collier and project controls professional Melanie Chiaradia provided key support in budget and reporting needs for this work. Susan Ennor and Cary Counts provided editorial support on this report.

Funding for this effort was provided through a subcontract with CH2M Hill Plateau Remediation Company. Pacific Northwest National Laboratory is operated for the U.S. Department of Energy by Battelle under Contract DE-AE05-76RL01830.

Acronyms and Abbreviations

%COV	percent coefficient of variation
AD	aerodynamic diameter
ANSI	American National Standards Institute
ASME	American Society of Mechanical Engineers
cfm	cubic feet per minute
CSB	Canister Storage Building
ft	feet
fpm	feet per minute
GEMS	generic effluent monitoring system
HPS	Health Physics Society
µm	micron(s)
min	minute(s)
WTP	Hanford Waste Treatment Plant

Contents

Summary	iii
Acknowledgments.....	v
Acronyms and Abbreviations	vii
1.0 Introduction	1.1
1.1 Stack Geometry.....	1.1
2.0 Methods	2.1
2.1 CSB Stack Qualification Test Results.....	2.2
2.2 Comparison Stacks.....	2.3
3.0 Results	3.1
3.1 Velocity Uniformity	3.1
3.2 Flow Angle.....	3.4
3.3 Gaseous Tracer Uniformity.....	3.7
3.4 Particulate Tracer Uniformity	3.10
4.0 Conclusions	4.1
5.0 References	5.1
Appendix A Canister Storage Building – Additional Velocity Test Sheets	A.1
Appendix B Geometries of More Complex Stacks.....	B.1
Appendix C Test Results of More Complex Stacks.....	C.1

Figures

1.1	Canister Storage Building Stack.....	1.2
2.1	Hanford 296-Z-7 Stack.....	2.4
2.2	Hanford B-Plant Stack.....	2.5
2.3	Hanford Waste Treatment Plant LV-C2 Stack.....	2.5
2.4	Hanford Waste Treatment Plant HV-C2 Stack.....	2.6
3.1	Hanford 296-Z-7 Velocity Uniformity.....	3.2
3.2	Scale Model Hanford B-Plant Velocity Uniformity.....	3.3
3.3	Hanford Waste Treatment Plant Scale Model LV-C2 Velocity.....	3.3
3.4	Hanford Waste Treatment Plant Scale Model HV-C2 Velocity Uniformity.....	3.4
3.5	Hanford 296-Z-7 Flow Angle.....	3.5
3.6	Scale Model Hanford B-Plant Flow Angle.....	3.6
3.7	Hanford Waste Treatment Plant Scale Model LV-C2 Flow Angle.....	3.6
3.8	Hanford Waste Treatment Plant Scale Model HV-C2 Flow Angle.....	3.7
3.9	Scale Model Hanford B-Plant Gaseous Tracer Uniformity. CSB gaseous tracer uniformity (open circles) is included for reference.	3.8
3.10.	Hanford Waste Treatment Plant Scale Model LV-C2 Gaseous Tracer Uniformity.....	3.9
3.11	Hanford Waste Treatment Plant Scale Model HV-C2 Gaseous Tracer Uniformity.....	3.9
3.12	Hanford 296-Z-7 Particulate Tracer Uniformity.....	3.11
3.13	Scale Model Hanford B-Plant Particulate Tracer Uniformity.....	3.11
3.14	Hanford Waste Treatment Plant Scale Model LV-C2 Particulate Tracer Uniformity.....	3.12
3.15	Hanford Waste Treatment Plant Scale Model HV-C2 Particulate Tracer Uniformity.....	3.12

Tables

2.1	Air Velocity Uniformity Test Results (from Mathews 2000).....	2.2
2.2	Flow Angle Test Results (from Mathews 2000).....	2.2
2.3	Gaseous Tracer Uniformity Test Results.....	2.3
2.4	Particulate Tracer Uniformity Test Results.....	2.3
3.1	Summary of Velocity Uniformity Fit Lines.....	3.1
3.2	Summary of Flow Angle Fit Lines.....	3.4
3.3	Summary of Gaseous Tracer Uniformity Fit Lines.....	3.7
3.4	Summary of Particulate Tracer Uniformity Fit Lines.....	3.10
4.1	Sample Stack Flows and Corresponding Stack Velocities.....	4.1

1.0 Introduction

The Canister Storage Building (CSB), a 42,000 square foot facility located in the 200 East area of the Hanford Site, is used to store spent nuclear fuel from past activities at the Hanford Site. Because the facility has the potential to emit radionuclides into the environment, its ventilation exhaust stack has been equipped with an air monitoring system. Subpart H of the National Emissions Standards for Hazardous Air Pollutants requires that a sampling probe be located in the exhaust stack according to criteria established by the American National Standards Institute/Health Physics Society Standard N13.1-1999, *Sampling and Monitoring Releases of Airborne Radioactive Substances from the Stack and Ducts of Nuclear Facilities* (ANSI/HPS 1999).²

The ability of the sampling probe location to meet the monitoring standard was demonstrated with a series of tests conducted on the stack itself in 1998 (Glissmeyer and Maughan 1999; Mathews 2000). These tests were performed for the then-current stack flow rates. While the stack flow rates during these tests were primarily between 9000 and 10,000 cubic feet per minute (cfm), the facility has since operated at lower stack flow rates of around 8000 cfm. CH2M Hill Plateau Remediation Company, as the operator of the CSB, has contracted with Pacific Northwest National Laboratory to assess the effect of the new stack flow rate. The purpose of this report is to present qualification test results from comparable stacks used to evaluate the impact of reduced flow rate on the qualification of the CSB stack sampling location.

1.1 Stack Geometry

The CSB stack has a relatively simple geometry, consisting of two fans located at the base of a vertical stack that is about 75 feet tall. The operating configuration is for one fan to be operational while the other is in standby mode. The internal stack diameter is 27.19 inches, and the sampling nozzle tip is located about 219.25 inches, or 8 duct diameters, from the intersection of the fan ducts with the main duct. Backdraft dampers are installed in the fan ducts. Figure 1.1 shows the general geometry of the CSB stack.

² The standard has been reaffirmed in 2011 and is identical to the 1999 version. The regulations have not been updated, so the 1999 version is still referenced.

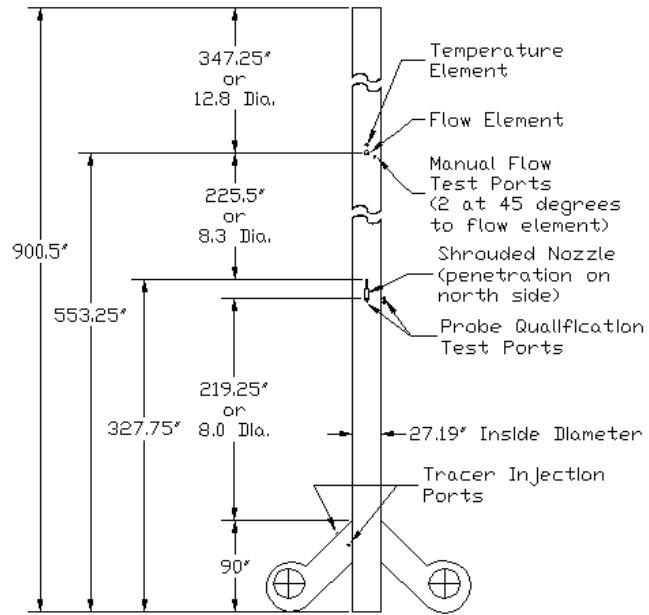

Figure 1.1. Canister Storage Building Stack (from Glissmeyer and Maughan 1999)

2.0 Methods

The CSB stack monitor location was qualified at flow rates between 9000 and 13,000 cfm; most tests were between 9000 and 9500 cfm. The facility has since operated at lower stack flow rates of around 8000 cfm. To evaluate the applicability of the previous test results to a more broad range of flow rates, other stack qualification test results over a range of flow rates were examined. The sections below briefly present the test results from the original CSB stack qualification tests and introduce other stack test results over a range of flow conditions that will be considered in assessing the applicability of the original CSB test results to a broader range of flow conditions.

The qualification criteria for the location of a stack air monitoring probe are taken from American National Standards Institute/Health Physics Society N13.1-1999, Section 5.2.2, and are paraphrased as follows:

1. *Uniform Air Velocity* – The air velocity must be fairly uniform across the stack cross section where the sample is extracted. Consequently, the velocity is measured at several discrete points in the duct cross section at the proposed location of the sampling nozzle. The uniformity is expressed as the variability of the measurements about the mean. This is expressed using the percent coefficient of variation (%COV),³ which is the standard deviation divided by the mean and expressed as a percentage—the lower the %COV value, the more uniform the velocity. The qualification criterion is that the %COV of the air velocity must be $\leq 20\%$ in the center two-thirds of the duct cross section where the sampling probe is to be located.
2. *Angular Flow*— Sampling nozzles are typically aligned with the axis of the stack. If the air travels through the stack in cyclonic fashion, the air velocity vector approaching a sampling nozzle could be sufficiently misaligned with the nozzle to impair extraction of particles. Consequently, the flow angle is measured at the proposed location of the sampling probe. The average of the flow angle measurements (made at the same grid of points as the velocity measurements) should not exceed 20° relative to the sampling nozzle axis.
3. *Uniform Concentration of Tracer Gases* – A uniform contaminant concentration in the sampling plane enables the extraction of samples that represent the true concentration within the duct. The uniformity of the concentration is first tested with a tracer gas to represent gaseous effluents. Fans are good mixers, so injecting the tracer downstream of a fan provides worst-case results. The qualification criteria are that 1) the %COV of the measured tracer gas concentration is $\leq 20\%$ across the center two-thirds of the duct cross section at the sampling location, and that 2) the concentrations at any of the measurement points cannot deviate from the mean by $>30\%$.
4. *Uniform Concentration of Tracer Particles*— The second set of tests addressing contaminant concentration uniformity at the sampling position uses tracer particles large enough to exhibit inertial effects. Tracer particles of $10 \mu\text{m}$ aerodynamic diameter (AD) are used by default unless it is known that larger contaminant particles will be present in the airstream. The qualification criterion is that the %COV of particle concentration is $\leq 20\%$ across the center two-thirds of the duct at the sampling location.

³ Percent *coefficient of variation* is considered “dated” terminology. The modern terminology is *percent relative standard deviation*. However, because the standard uses the older terminology, %COV is used in this report.

2.1 CSB Stack Qualification Test Results

The velocity uniformity and flow angle tests were performed by Duke Engineering and Services Hanford, Inc., and reported by Mathews (2000). Table 2.1 and Table 2.2 summarize the velocity uniformity and flow angle tests that were performed at the CSB. Velocity values are the average of all of the measurement points across the stack (including the center point), and airflow is calculated from the velocity and duct area. Note that only one test of each kind was reported by Mathews (2000), but two additional velocity uniformity tests were available through personal records.⁴ These additional tests were performed at slightly lower flow rates, with slightly higher %COV values. The data sheets from these tests are included in Appendix A. For the final test listed in Table 2.1, which was reported by Mathews (2000), there appeared to be a discrepancy between the generic effluent monitoring system (GEMS) instrument airflow reported on the data sheet and the mean velocity measurement. Therefore, both the flow rate listed on the data sheet as well as the flow rate calculated based on the mean velocity are listed. An airflow value was not recorded during the flow angle test. Both the velocity and flow angle test results were well within the qualification criteria.

Table 2.1. Air Velocity Uniformity Test Results (from Mathews 2000)

%COV	Airflow, cfm	Velocity, fpm
5.4 ^(a)	9707	2270
7.4 ^(a)	9741	2278
4.4	12879 (9250) ^(b)	3012

(a) Personal communication (J. Glissmeyer, January 2016; see data sheets in Appendix A.)
 (b) Flow rate calculated from velocity, GEMS flow rate in parenthesis

Table 2.2. Flow Angle Test Results (from Mathews 2000)

Flow Angle, degrees	Airflow, cfm
9	NA

The gaseous tracer and particulate tracer uniformity tests were performed by Pacific Northwest National Laboratory staff, as reported by Glissmeyer and Maughan (1999). The test results are summarized in Table 2.3 and Table 2.4. Tracer was injected at the base of the stack, downstream of the fans as identified in Figure 1.1. Note that the airflow column in Table 2.4 uses the average of the stack flow rates listed in the start and finish columns of the data sheet, which is consistent with the flow rates used in Table 2.3, rather than the values listed in the body of the Glissmeyer and Maughan (2000) report. In addition, the velocity values are the average of the centerline measurements made at the start and finish of the test. The gaseous tracer tests were all below 8%COV, and there was a high degree of repeatability in the test result at the center injection position. The particulate tracer test results were fairly high relative to the stack qualification criterion.

⁴ Personal communication with J. Glissmeyer, Pacific Northwest National Laboratory, January 2016.

Table 2.3. Gaseous Tracer Uniformity Test Results

Injection Point	%COV	Max % Deviation from Mean	Airflow, cfm	Velocity, fpm
Center	7.9	17	9055	2588
Center	7.3	20	9055	2546
Center	6.9	23	9055	2555
Top Left	2.9	6	9170	2548
Top Right	6.4	17	9135	2551
Bottom Left	1.9	6	9183	2579
Bottom Right	6.3	13	9175	2609

Table 2.4. Particulate Tracer Uniformity Test Results

Injection Point	%COV	Airflow, cfm	Velocity, fpm
Center	15.7	9280	2494
Center	18.2	9255	2664

2.2 Comparison Stacks

Over the course of many years of performing stack qualification tests, a variety of stacks and stack conditions have been assessed. To evaluate the impact of a reduced stack flow rate on the stack qualification test results for the CSB, other stack qualification test results over a range of flows were examined. Test results from 13 separate stacks were compiled. The geometries of four of these stacks were comparable to the CSB geometry. The remaining stacks were more complex; they had additional bends, changes in duct size and shape, or additional fans. This analysis focuses on the four most geometrically similar stacks. Images of the remaining stacks are included in Appendix B. Note that the figures presented in this section, as well as the figures in Appendix B, show multiple injection or sampling ports for some of the stacks. Injection ports are used for the injection of the gaseous or particulate tracers, and multiple options may exist due to the presence of multiple fans. Multiple candidate sampling port locations were considered for some of the stacks, so corresponding test port locations were used to conduct uniformity measurements in those cases.

Of the stacks reviewed, the 296-Z-7 stack is the most similar to the CSB stack. Located at the Plutonium Stabilization and Handling facility in the Hanford 200-West Area, the 296-Z-7 stack had two fans at the base of a vertical stack. The flow rate in this stack was expected to be between 1550 and 1800 cfm, with one duty fan and one standby fan. The internal diameter of this stack was 15.25 inches, and the total stack height was 50 feet. Measurements were made for both the normal, expected flow rates as well as a reduced emergency flow rate of about 300 cfm. All tests were performed using the southern fan; test results are expected to be similar using the northern fan due to the symmetry of their installation. Figure 2.1 depicts the stack geometry for the 296-Z-7 stack (Glissmeyer and Maughan 2001).

The B-Plant stack (Glissmeyer and Maughan 1998) was a new stack tested for the retired plutonium processing plant located in the 200-East Area. The exhaust airflow for this facility was about 15,000 cfm. The stack internal diameter was 31.125 inches, and the stack was 90 feet tall. Two fans, one duty and one

standby, were located at the base of the stack. Both fans were located on one side of the stack, and there was one junction between the fans and the main stack. A scale model of this stack was built for qualification testing to enable testing in a radiologically clean environment. Figure 2.2 shows the geometry of the B-Plant stack.

The Hanford Waste Treatment Plant (WTP) LV-C2 stack exhausts non-process areas such as hallways, instrument rooms, and mechanical rooms in the Low-Activity Waste facility. The actual stack has a 60-inch-diameter duct with a normal flow of about 50,000 cfm. Tests were performed with a scale model of the stack (Glissmeyer et al. 2015). This stack configuration is very similar to the B-Plant stack, except that the fan duct turns into the main, vertical stack through a 90-degree sweep. Although normal operations have one duty fan and one standby fan, tests were also performed with both fans operating. Figure 2.3 shows the geometry of the WTP LV-C2 stack.

The WTP HV-C2 stack serves non-process operating areas in the High-Level Waste facility. Like the LV-C2 stack, the HV-C2 stack has a 60-inch diameter, and was tested with a scale model (Glissmeyer and Droppo 2007). The full-scale stack flow rate was about 40,000 cfm, which is achieved either with one fan operating and one on standby, or with both fans operating. In this stack, one fan duct turns into the main, horizontal stack through a 45-degree sweep. The second fan duct joins the main duct at a 45-degree intersection. Figure 2.4 shows the geometry of the HV-C2 stack.

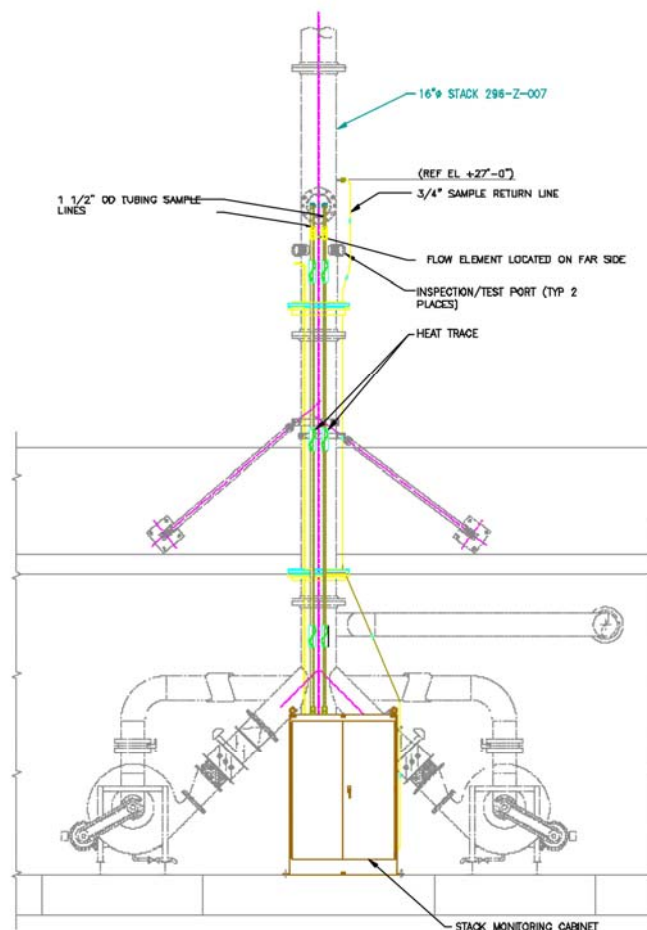

Figure 2.1. Hanford 296-Z-7 Stack (from Glissmeyer and Maughan 2001)

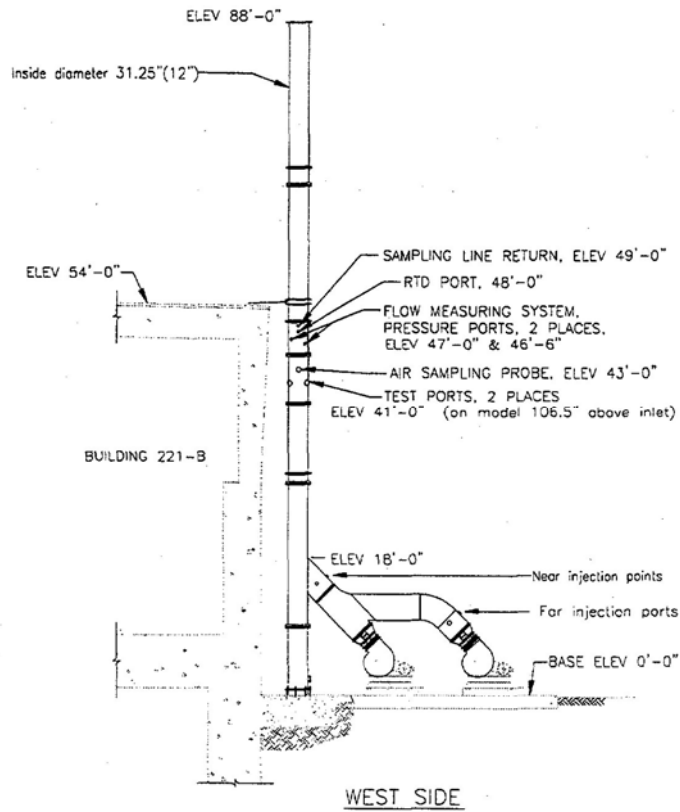

Figure 2.2. Hanford B-Plant Stack (from Glissmeyer and Maughan 1998)

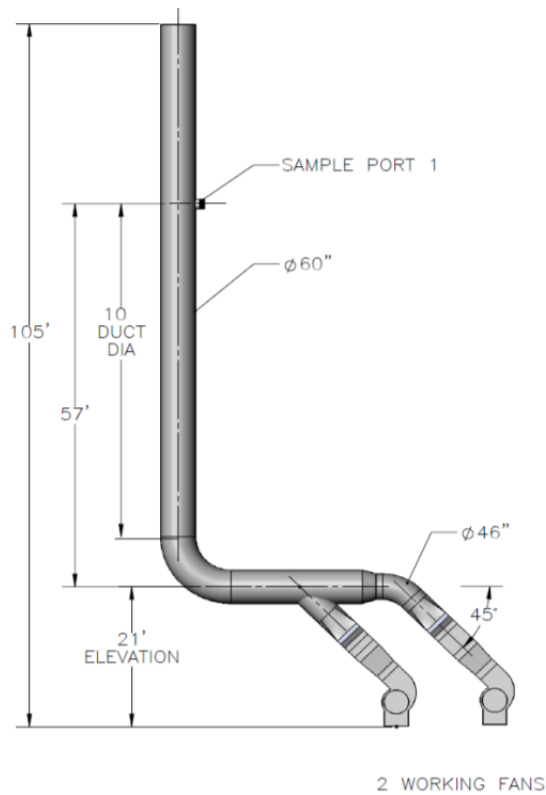

Figure 2.3. Hanford Waste Treatment Plant LV-C2 Stack

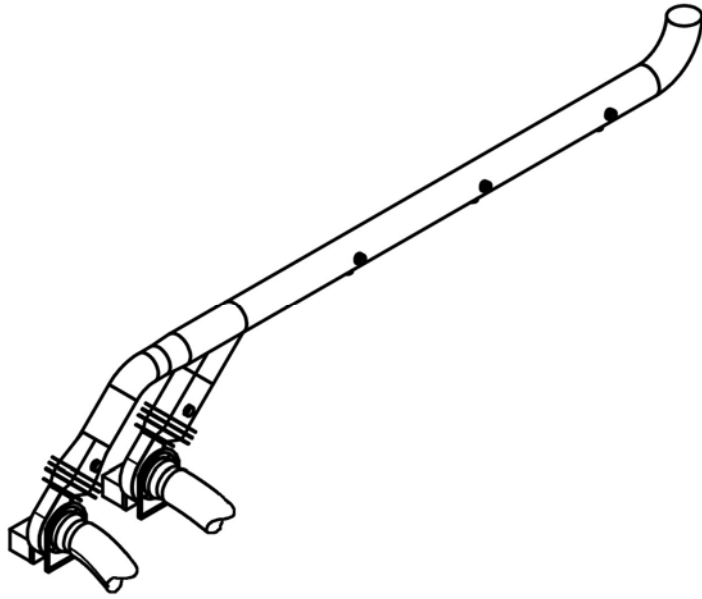

Figure 2.4. Hanford Waste Treatment Plant HV-C2 Stack

3.0 Results

This section presents the data from the 4 most similar stacks from the group of 13 stacks for which qualification test results were considered. Data from the remaining nine stacks are included in Appendix C. Although the complexities of these stack geometries are sometimes apparent in the test results included in Appendix C, most often, the basic characteristics of the data are comparable to the data presented in this section. Figures summarize the outcome of individual test cases, and fit lines are included for tests under similar stack testing conditions. These results, as well as comparisons with the original CSB test results, are presented in the sections below according to the type of test performed. Each figure is plotted with the stack velocity (rather than the stack flow rate) along the abscissa. This allows the abscissa range for each plot to be same throughout this section.

Note that the velocity, gaseous tracer, and particulate tracer uniformity test results are all presented in %COV, while the flow angle results are presented in degrees. A formal error analysis has not been performed for these results; however, the primary errors that contribute to these calculations are systematic and random instrument and random measurement position errors. Differences of 1 to 2 %COV or 1 to 2° in test results are attributable to the typical errors of the measurement technique.

3.1 Velocity Uniformity

Velocity uniformity tests were performed at several stack velocities for each of the four stacks examined here. To summarize the tests, linear fit lines are presented in Table 3.1. The sign of the slope (positive or negative) is listed in a separate column to enable a quick assessment of whether a reduced stack velocity is expected to reduce or increase the %COV. Positive slope signs indicate that %COV values increase with increasing velocity, meaning that the velocity profile is less uniform with velocity. The slope value is expressed as a %COV over a 1000 fpm stack velocity to give a sense of the magnitude of change in the velocity uniformity result. Finally, the coefficient of determination (R^2) and the number of data points (N) are included.

Table 3.1. Summary of Velocity Uniformity Fit Lines

Stack	Slope Sign	Slope Value	R^2	N
296-Z-7	Negative	2.2%/1000 fpm	0.81	4
B-Plant (Near Fan)	Positive	0.8%/1000 fpm	0.47	3
LV-C2 (Fan B)	Negative	0.8%/1000 fpm	0.20	7
HV-C2 (All)	Positive	0.3%/1000 fpm	0.04	13

The 296-Z-7 stack test was performed with just one fan, and at the proposed sampling location (see Figure 3.1). The %COV values were slightly higher at lower stack velocities, but well within the stack qualification criterion of 20%COV. The CSB test results are also shown in Figure 3.1 (and all subsequent figures, when available) for comparison.

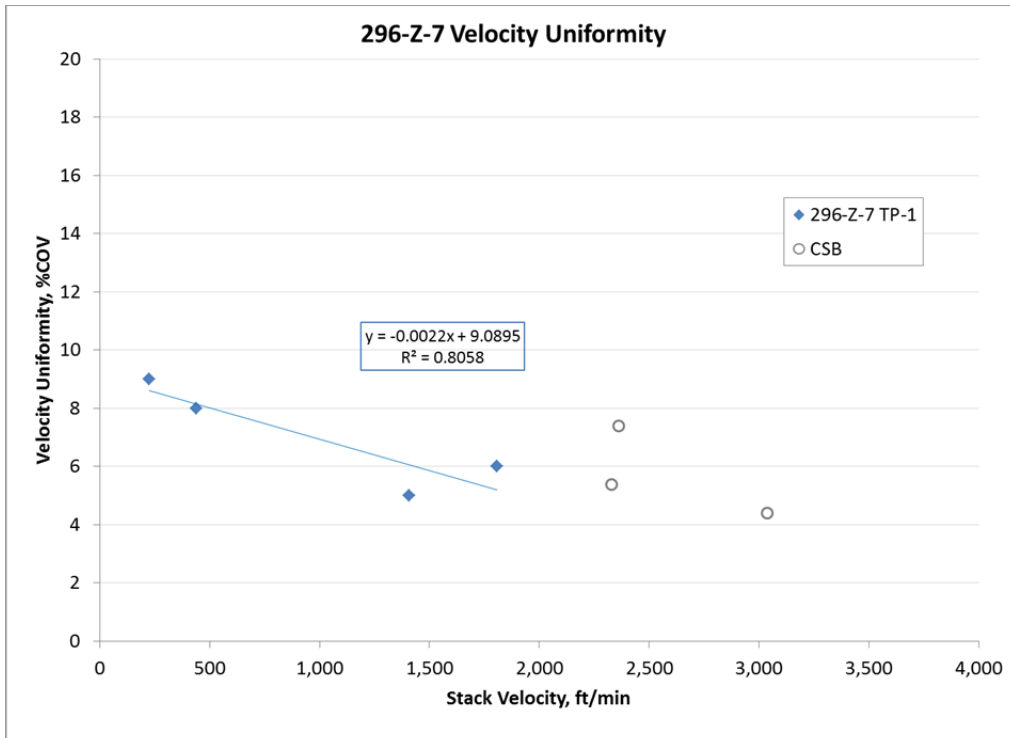

Figure 3.1. Hanford 296-Z-7 Velocity Uniformity. CSB velocity uniformity (open circles) is included for reference.

The B-Plant stack was tested with each fan separately (see Figure 3.2). Operation with the near fan is most similar to the CSB configuration, so the fit for those data are included in Table 3.1. All test results were well within the stack qualification criterion; values were $\leq 5\%COV$.

The LV-C2 stack was also tested with each fan separately, as well as with both fans operating. In general, the velocity uniformity values are higher with Fan B (closer to the stack bend) than with Fan A (farther upstream), and in the cases where both fans were operating the velocity uniformity values fall between the values of the two single-fan cases (see Figure 3.3). The Fan B operating condition results in velocity uniformity results that are slightly less uniform at lower stack velocities.

Finally, the HV-C2 stack was tested with each fan individually as well as combined. However, tests were not performed at both the higher velocity and lower velocity for each fan condition. Therefore, only a fit line for all test cases (Fan A, Fan B, and combined Fan A and B operations) is included. The only data point excluded from the fit line in Figure 3.4 and Table 3.1 is the 45 degree damper case. The normal backdraft damper angle when the stack is operating is expected to be 70 degrees.

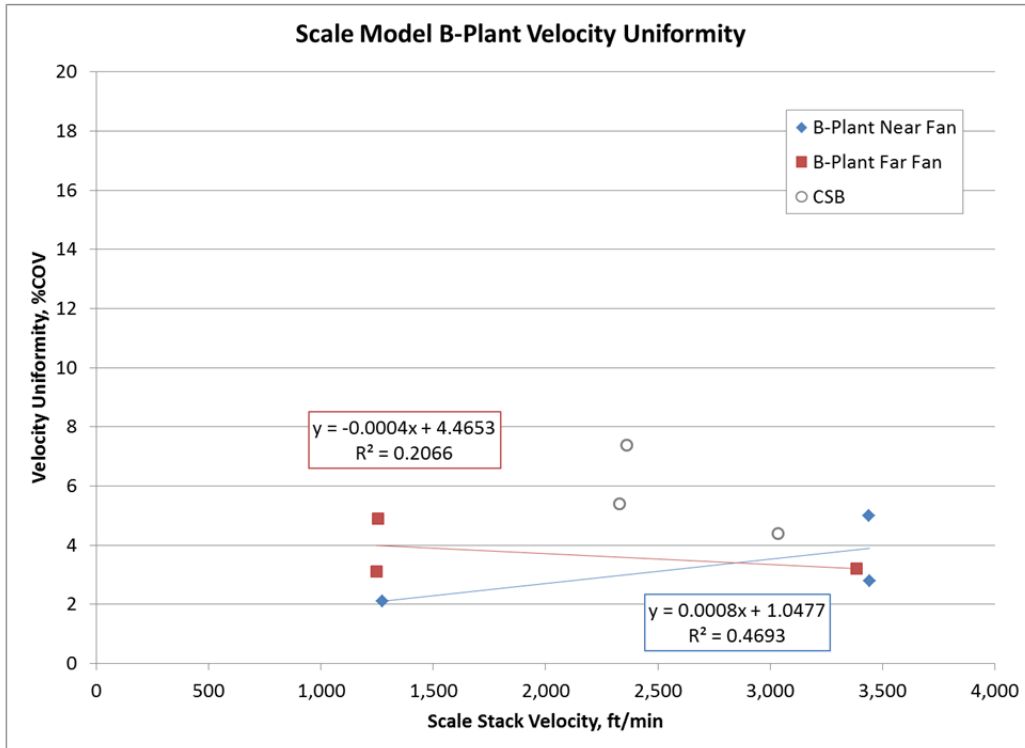

Figure 3.2. Scale Model Hanford B-Plant Velocity Uniformity. CSB velocity uniformity (open circles) is included for reference.

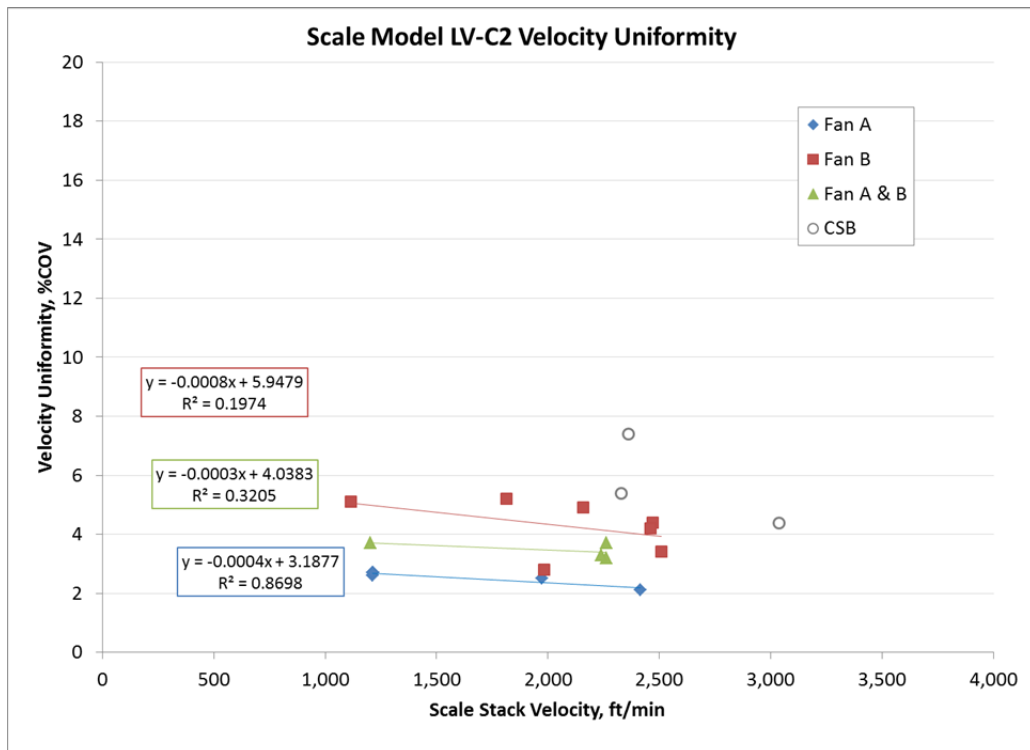

Figure 3.3. Hanford Waste Treatment Plant Scale Model LV-C2 Velocity. CSB velocity uniformity (open circles) is included for reference.

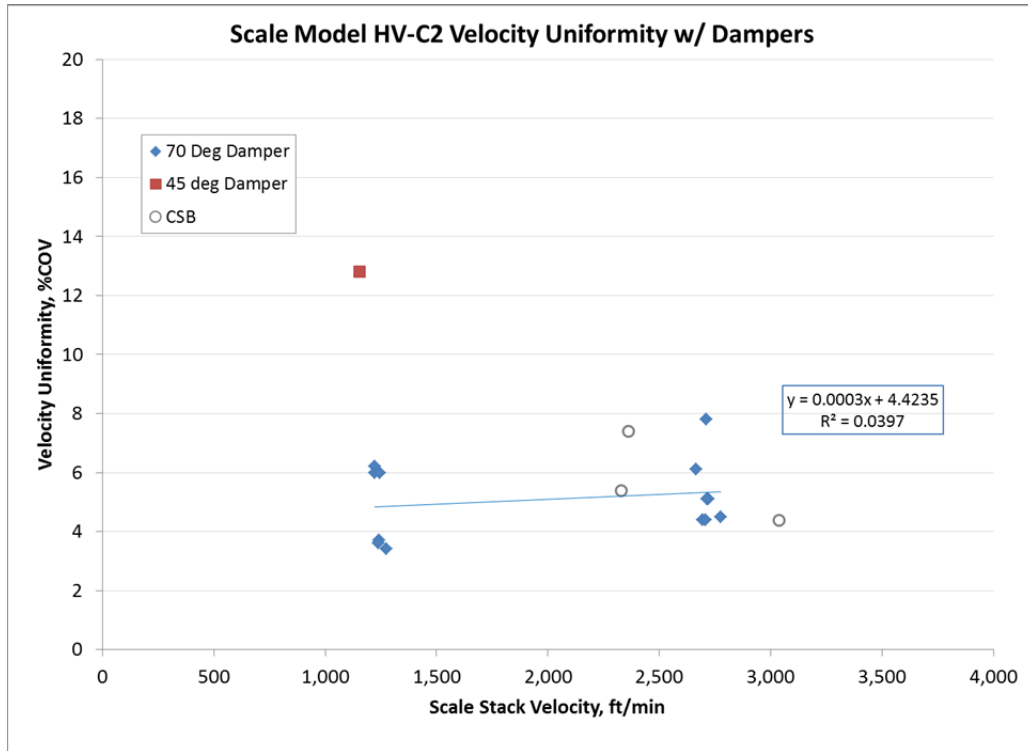

Figure 3.4. Hanford Waste Treatment Plant Scale Model HV-C2 Velocity Uniformity. CSB velocity uniformity (open circles) is included for reference.

3.2 Flow Angle

Flow angle tests are available for the four stacks examined here, and Table 3.2 summarizes the fit lines for the test data from these four stacks. Note that the 296-Z-7 and B-Plant stacks, which both had only two data points for the linear fit, had slope values larger than $1^\circ/1000$ fpm. Although the B-Plant slope was negative, the other fit lines for the other stacks were positive, meaning that increased stack velocity or flow rate is expected to result in a larger flow angle. The R^2 values for the two WTP stacks are low, indicating that the trend does not represent the data points well.

Table 3.2. Summary of Flow Angle Fit Lines

Stack	Slope Sign	Slope Value	R^2	N
296-Z-7	Positive	2.1°/1000 fpm	1.0	2
B-Plant (Near Fan)	Negative	5.0°/1000 fpm	1.0	2
LV-C2 (Fan B)	Positive	0.5°/1000 fpm	0.12	6
HV-C2 (All)	Positive	0.3°/1000 fpm	0.03	11

Figure 3.5 shows the flow angle results from the 296-Z-7 stack, which only had two tests; one at a higher velocity of around 1400 fpm, and one at a lower velocity of around 250 fpm. The difference between the two tests was slightly more than two degrees, and both tests were well within the qualification criterion. As mentioned previously, the flow rate during the CSB flow angle test was not available, so the flow angle value was not plotted with these stack results.

The B-Plant flow angle results are shown in Figure 3.6. Only two tests were performed with the near fan on this stack, and the difference between the two test results was a little more than 1 degree. Considering the errors in the test method, these test results are effectively the same flow angle. In addition, both tests were less than 5°, which is well within the qualification criterion.

Figure 3.7 shows the flow angle tests performed on the LV-C2 scale model stack with different fan configurations. Fan B, which is closer to the stack bend, generally had higher flow angle values than Fan A, while the combination of both fans operating fell in between the results of the single-fan conditions. In all cases, flow angles were less than 7° and were slightly lower at lower velocities.

The HV-C2 flow angle test results are shown in Figure 3.8. Because data were insufficient (only one velocity was represented) for the Fan A, Port 1 test condition to fit a line, all of the available data, which includes each individual fan as well as both fans combined, and test ports at three different locations along the stack.

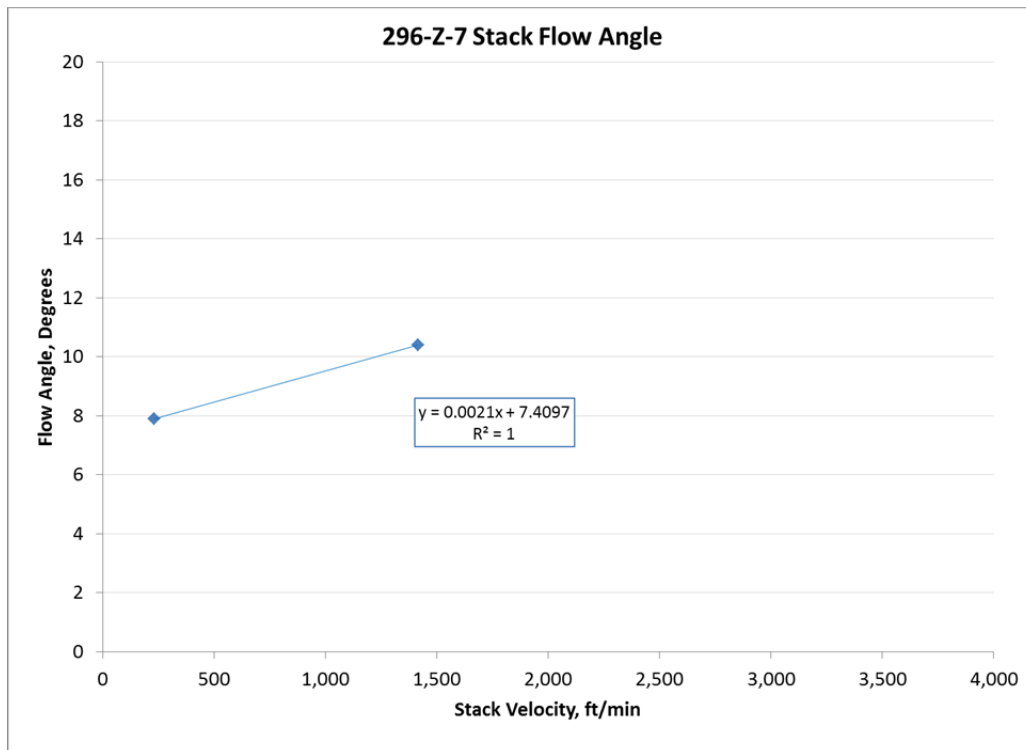

Figure 3.5. Hanford 296-Z-7 Flow Angle

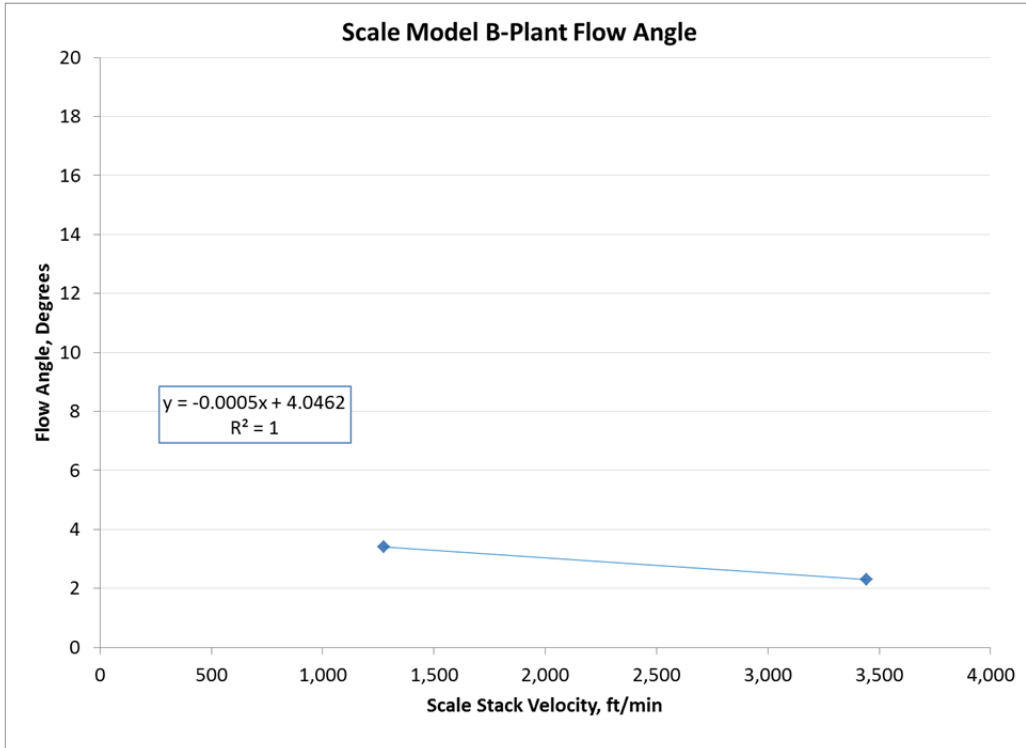

Figure 3.6. Scale Model Hanford B-Plant Flow Angle

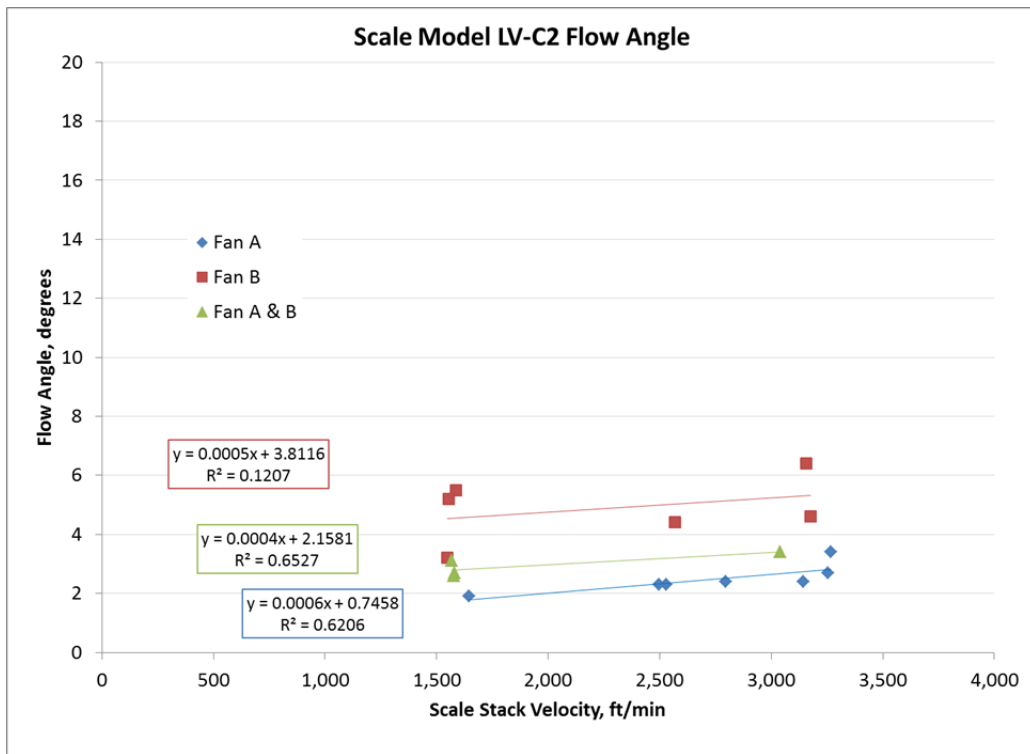

Figure 3.7. Hanford Waste Treatment Plant Scale Model LV-C2 Flow Angle

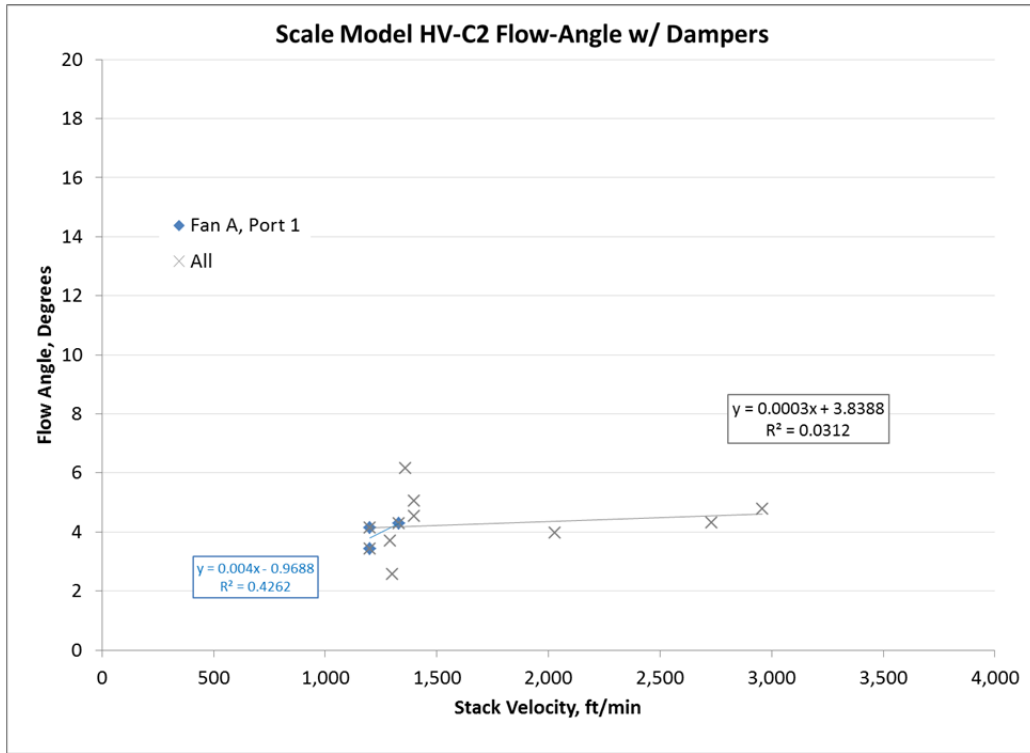

Figure 3.8. Hanford Waste Treatment Plant Scale Model HV-C2 Flow Angle

3.3 Gaseous Tracer Uniformity

The results of gaseous tracer uniformity tests conducted over a range of velocities are available for three of the stacks examined. Table 3.3 summarizes the fit lines for the test data from these three stacks. The 296-Z-7 stack tests were performed at essentially one velocity condition (about 1400 fpm), so no fit line is available. Generally, however, the test results indicated a high level of mixing; all results were below 3%COV. The B-Plant slope was negative while the other two stacks had positive slopes. However, both the B-Plant and LV-C2 stacks had very low R^2 values.

Table 3.3. Summary of Gaseous Tracer Uniformity Fit Lines

Stack	Slope Sign	Slope Value	R^2	N
296-Z-7	NA	NA	NA	NA
B-Plant (Near Fan)	Negative	0.1%/1000 fpm	0.02	5
LV-C2 (Fan B)	Positive	0.01%/1000 fpm	0.004	7
HV-C2 (All)	Positive	2.2%/1000 fpm	0.80	3

The B-Plant gaseous tracer uniformity test was performed with three tests at a higher stack velocity and two tests at a lower stack velocity. The center injection position was the only test with multiple high and low velocities, so they are plotted in Figure 3.9. However, additional tests were performed with other injection positions. Although a linear fit was applied to these data, the R^2 value is low and the resulting values themselves are not distinctly different for the two flow conditions. All test results were between 8 and 5%COV.

The LV-C2 gaseous tracer tests were performed at high and low stack velocities for a different injection location for each fan (see Figure 3.10). Fan B test results were generally low values (around 3%COV or less), with one outlier of around 6%COV. The outlier drives the slope to a slightly positive slope, while the remaining data point toward a negative slope.

Finally, the HV-C2 stack gaseous tracer uniformity tests are presented in Figure 3.11. Varying stack velocities were not available at each fan operating condition, so results have been grouped according to test port location and center injection position. Test Port 1, which is farthest upstream in the duct, had generally higher %COV values (less mixing) than the other ports. Note that there is a small range of stack velocities with the center injection position, so the slopes for all three ports are quite steep. When all injection locations and all ports are plotted together, the slope decreases significantly (grey line).

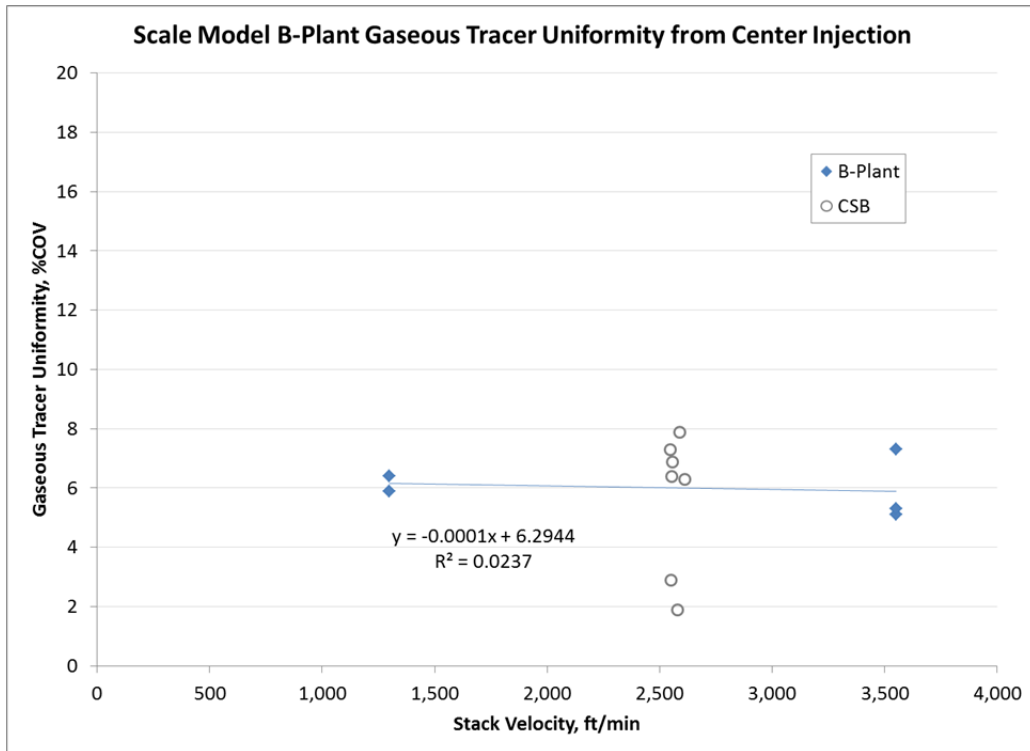

Figure 3.9. Scale Model Hanford B-Plant Gaseous Tracer Uniformity. CSB gaseous tracer uniformity (open circles) is included for reference.

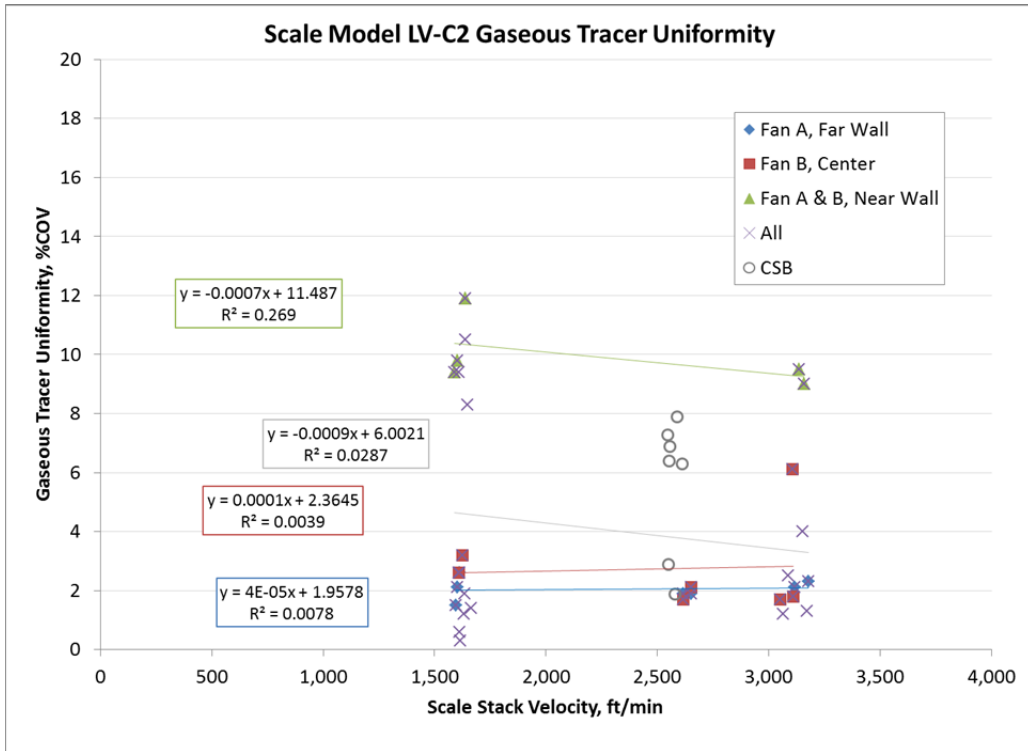

Figure 3.10. Hanford Waste Treatment Plant Scale Model LV-C2 Gaseous Tracer Uniformity. CSB gaseous tracer uniformity (open circles) is included for reference.

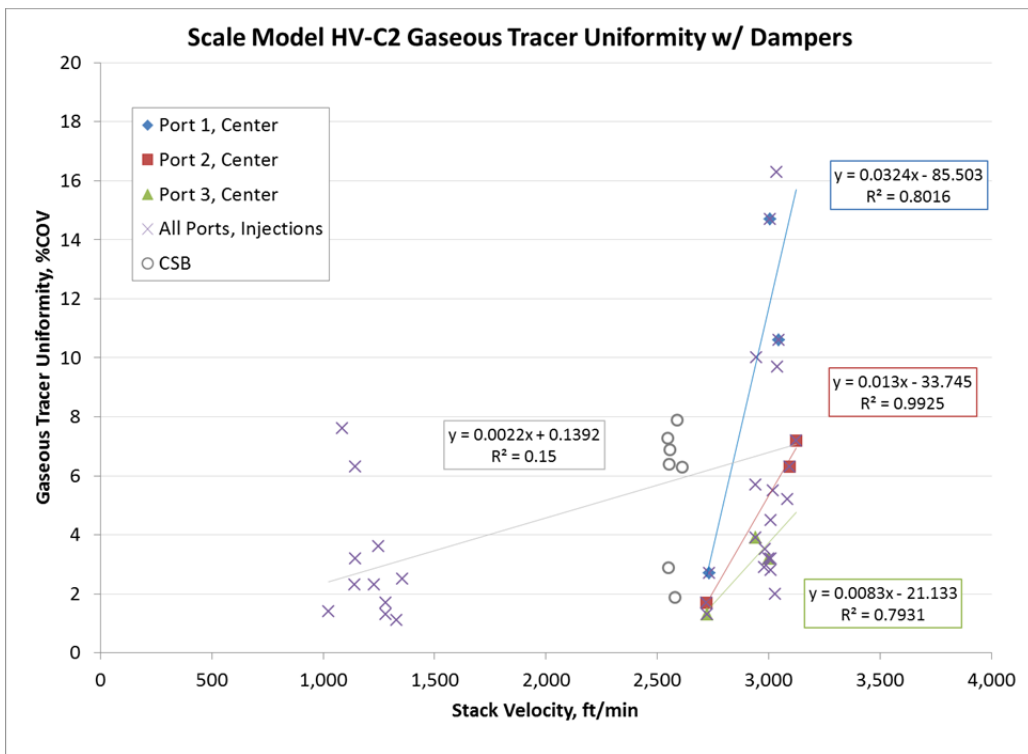

Figure 3.11. Hanford Waste Treatment Plant Scale Model HV-C2 Gaseous Tracer Uniformity. CSB gaseous tracer uniformity (open circles) is included for reference.

3.4 Particulate Tracer Uniformity

Particulate tracer uniformity tests were performed at several stack velocities for each of the four stacks examined here. A summary of the linear fit to these tests is presented in Table 3.4. For these tests, the fit lines for all four stacks had positive slopes, with slope values $\geq 2\%$ over a 1000 fpm increase in stack velocity. The CSB stack particulate tracer uniformity test results were the closest to the threshold for the qualification criterion among the four test types. The results of the other stacks indicate that a reduced stack flow is likely to improve the particulate mixing and reduce the COV.

Table 3.4. Summary of Particulate Tracer Uniformity Fit Lines

Stack	Slope Sign	Slope Value	R ²	N
296-Z-7	Positive	2.2%/1000 fpm	0.99	3
B-Plant (Near Fan)	Positive	2.0%/1000 fpm	0.97	3
LV-C2 (Fan B)	Positive	2.3%/1000 fpm	0.38	6
HV-C2 (All, Port 2)	Positive	4.8%/1000 fpm	0.83	4

Figure 3.12 presents the 296-Z particulate uniformity results, which involved only three tests. These test results were nearly 6%COV at the higher stack velocity of around 1500 fpm, and 3%COV at the lower stack velocity of around 250 fpm.

The B-Plant particulate uniformity tests were performed under similar conditions—two tests at high flow and one at lower flow—and the test results are presented in Figure 3.13. The high flow rate result was around 12%COV, while the low flow rate result was around 8%COV. This difference is sufficient to conclude that there is a real reduction in particulate tracer uniformity (increasing %COV) with increasing stack velocity.

As noted for the previous tests (and related figures), the LV-C2 scale model stack was tested with each fan operating individually as well as with both fans operating simultaneously (see Figure 3.14). Under all fan operating conditions, the particulate uniformity decreased with increasing velocity. The slope values are similar among fan operating conditions, but the Fan B tests had the lowest slope value (and the lowest R² value).

Finally, the HV-C2 particulate uniformity test results are presented in Figure 3.15. Varying stack velocities were not available for each fan operating condition, so results have been grouped according to test port location. Test Port 1, which is the most upstream of the three ports, had two points that appear to be outliers compared to the remaining results. A test with both fans operating simultaneously had a result of 31%COV, while one of the Fan A tests had a 14%COV. The bulk of the tests results at Ports 2 and 3 were reasonably similar; a grouping of test results was around 3%COV at the lower velocity and a grouping was between 7 and 14%COV at the higher velocity.

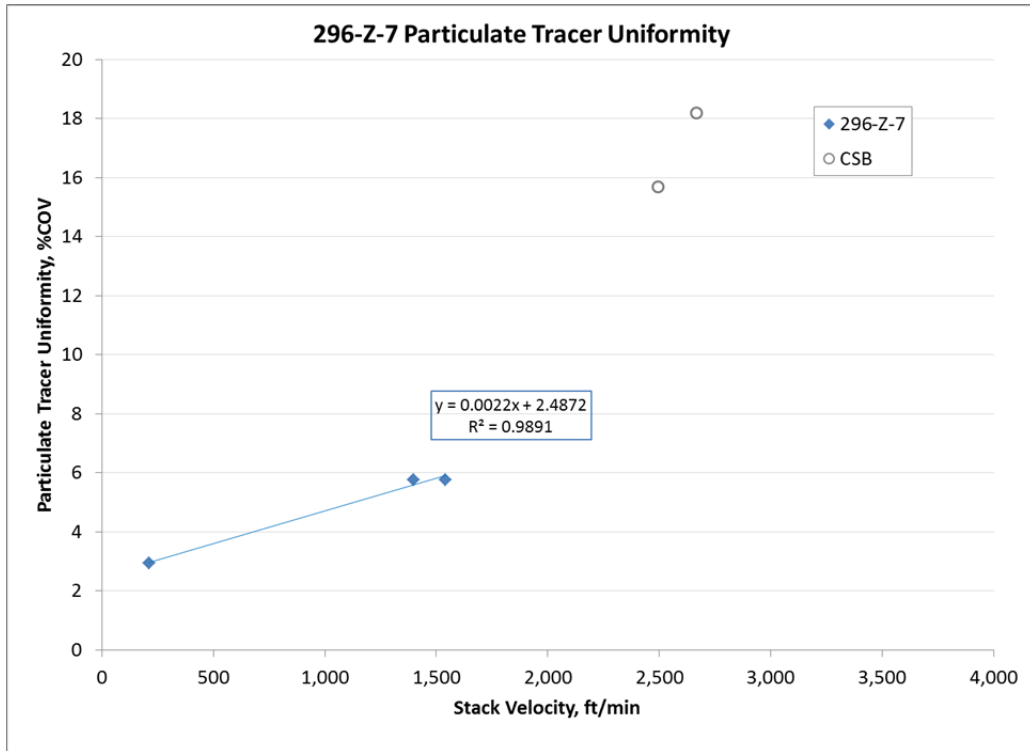

Figure 3.12. Hanford 296-Z-7 Particulate Tracer Uniformity. CSB particulate tracer uniformity (open circles) is included for reference.

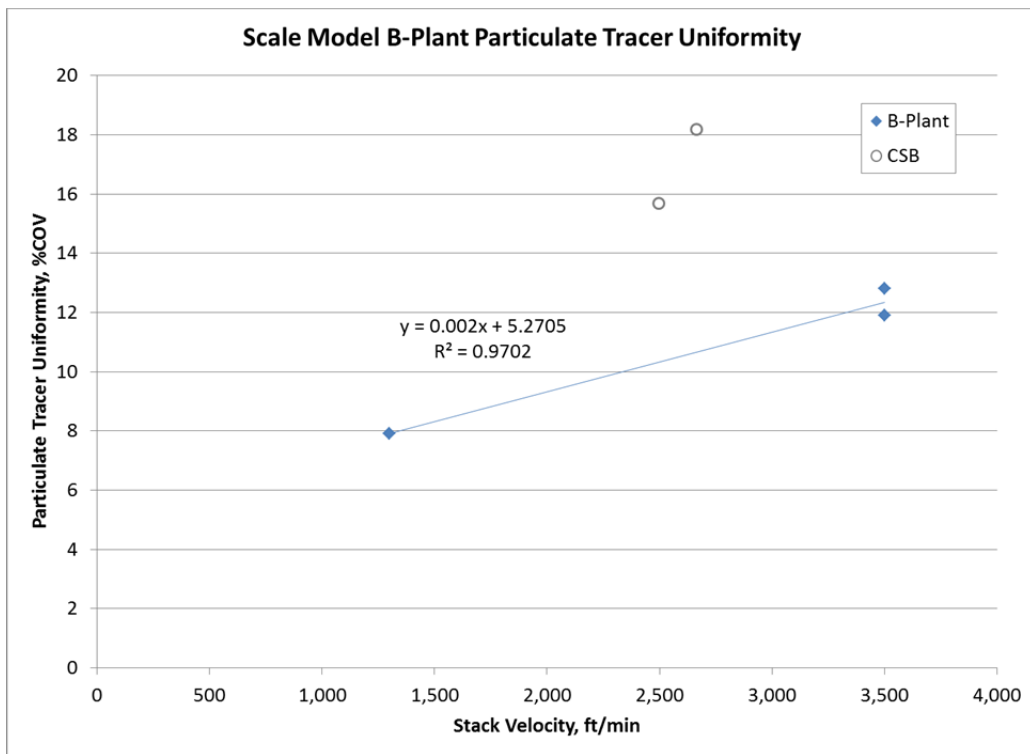

Figure 3.13. Scale Model Hanford B-Plant Particulate Tracer Uniformity. CSB particulate tracer uniformity (open circles) is included for reference.

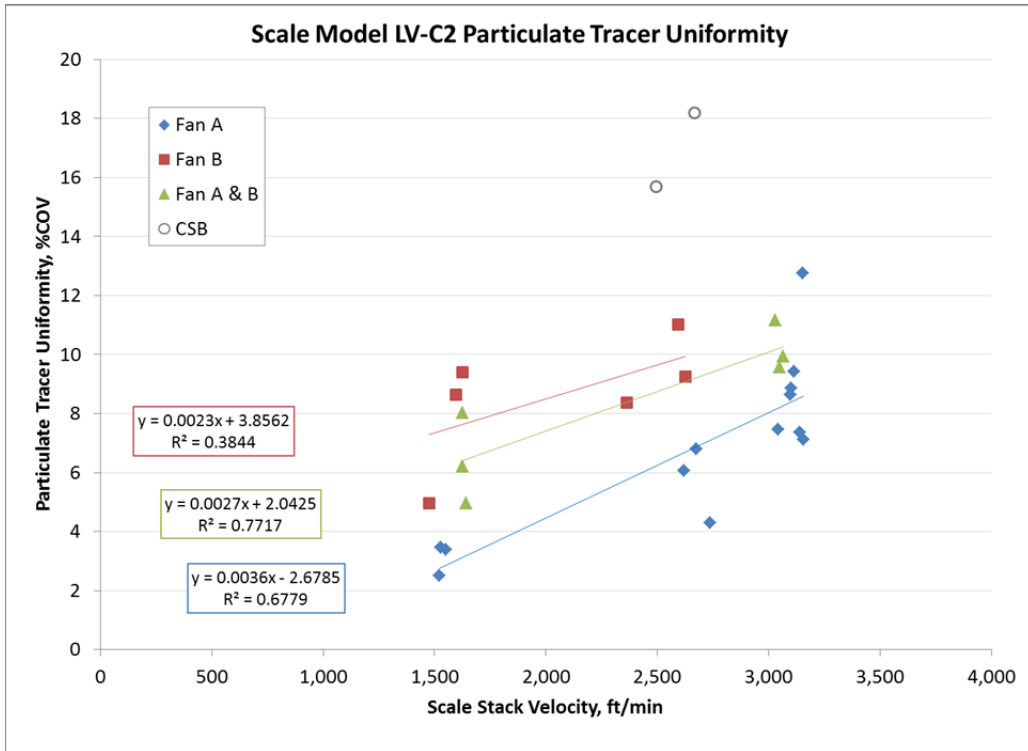

Figure 3.14. Hanford Waste Treatment Plant Scale Model LV-C2 Particulate Tracer Uniformity. CSB particulate tracer uniformity (open circles) is included for reference.

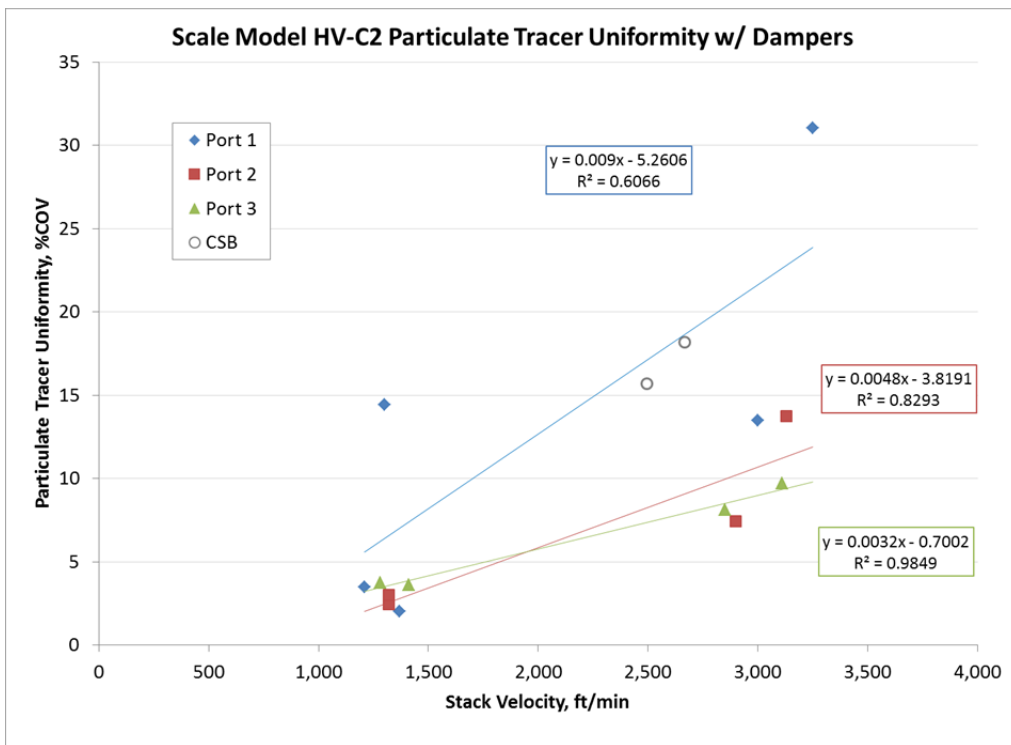

Figure 3.15. Hanford Waste Treatment Plant Scale Model HV-C2 Particulate Tracer Uniformity. Note the change in y-axis range compared with previous figures. CSB particulate tracer uniformity (open circles) is included for reference.

4.0 Conclusions

The CSB stack qualification tests were performed over a narrow range of flow rates that did not capture the current, reduced flow rate. Thirteen total stacks were considered, but four stacks that are most geometrically similar to the CSB stack and had stack qualification test results over a range of velocities were examined in the body of this report. These four stacks were examined to explore the likelihood that the CSB stack sampling location would remain acceptable at lower flows.

In general, the linear fits of the stack qualification result (%COV or flow angle in degrees) as a function of stack velocity had modest to poor coefficients of determination. There are several factors to consider in interpreting the results presented here. First, the tests performed for these stacks were not designed to investigate the relationship between the qualification test results and velocity. Tests were performed to cover the expected range of flow conditions, so more conclusive results for the purposes of the current investigation may be possible if the testing were specifically performed to systematically vary the stack velocity. Some fit lines included varying port or fan conditions to obtain sufficient points to develop a fit line. In addition, the weak mathematical correlation between stack qualification test results and velocity points to the lack of a strong physical correlation between the two parameters. Although lower velocities allow more time for mixing than higher velocities, the level of turbulence in the duct also affects mixing, as does the geometry of the duct.

Table 4.1 lists calculated stack velocity values that correspond to selected CSB stack flow rates. The original tests to qualify the CSB stack was performed at around 9000 cfm, which corresponds to a mean stack velocity of 2232 fpm based on the stack cross-sectional area. If the stack flow was reduced to 5000 cfm, the stack velocity would be reduced to 1240 fpm. This table illustrates that a 1000 fpm reduction in stack velocity (from 2232 to 1240 fpm) corresponds to a 4000 cfm reduction in stack flow (from 9000 to 5000 cfm).

Most often the slope of the fit line to the stack qualification test results was less than 2.5%COV/1000 fpm for the uniformity tests or 2.5°/1000 fpm for the flow angle test. As mentioned previously, the typical error of the measurement technique is on the order of 2%COV or 2°. Therefore, a large portion of the differences in test results over a 1000 fpm change in velocity could be attributable to normal testing error. In addition, most of the CSB qualification test results were well within the qualification criteria, so even for those instances when the slope is negative, an increase of 2.5%COV or 2° is unlikely to impact the stack qualification status. The one exception to this is the particulate tracer uniformity test, for which results were as high as 18.2%COV. However, the particulate tracer uniformity test results for the most geometrically similar stacks all had fit lines with a positive slope, meaning that there was a reduction in the %COV value (or an increase in the uniformity) with reduced stack velocity.

Table 4.1. Sample Stack Flows and Corresponding Stack Velocities

Stack Flow, cfm	Stack Velocity, ft/min
9000	2232
7000	1736
5000	1240

Stack qualification test results from four stacks that are geometrically similar to the CSB stack were examined to evaluate the impact of reduced stack flow rate. The data show that there is often a small slope to the fit line between the velocity of the test and the test result (%COV or degrees). For the CSB stack, it appears that the velocity could be reduced by 1000 fpm without significant impact on the uniformity of the velocity or gaseous tracer. Particulate tracer uniformity may be affected more significantly, but the uniformity is expected to improve with reduced velocity. In addition, the flow angle is not expected to change appreciably with stack velocities lowered by 1000 fpm. Therefore, for all of the qualification test types, it appears that, relative to the maximum tested flow rate, a nearly 50% reduction in flow rate (or 1000 fpm reduction in velocity) would result in test results that fall within criteria limits.

5.0 References

American National Standards Institute and the Health Physics Society (ANSI/HPS). 1999. *Sampling and Monitoring Releases of Airborne Radioactive Substances from the Stacks and ducts of Nuclear Facilities*. ANSI/HPS N13.1-1999, McLean, Virginia (reaffirmed in 2011 as ANSI/HPS N13.1-2011).

Glissmeyer JA, EJ Antonio, and JE Flaherty. 2015. *Assessment of the LV-C2 Stack Sampling Probe Location for Compliance with ANSI/HPS N13.1-1999*. PNNL-24467, Pacific Northwest National Laboratory, Richland, Washington.

Glissmeyer JA and JG Droppo. 2007. *Assessment of the HV-C2 Stack Sampling Probe Location*. PNNL-16611, Pacific Northwest National Laboratory, Richland, Washington.

Glissmeyer JA, and AD Maughan. 1998. *Airborne Effluent Monitoring System Certification for New B-Plant Ventilation Exhaust Stack*. PNNL-12017, Pacific Northwest National Laboratory, Richland, Washington.

Glissmeyer JA and AD Maughan. 1999. *Airborne Effluent Monitoring System Certification for New Canister Storage Building Ventilation Exhaust Stack*. PNNL-12166, Pacific Northwest National Laboratory, Richland, Washington.

Glissmeyer JA and AD Maughan. 2001. *Qualification Tests for the Air Sampling System at the 296-Z-7 Stack*. PNNL-13687, Pacific Northwest National Laboratory, Richland, Washington.

Mathews JP. 2000. *Stack Monitoring Regulatory Test*. Test Results Summary, Preoperational Acceptance Test No. SNF-W379-TRP-010-2, Rev. 0, Spent Nuclear Fuel Project, Duke Engineering and Services, Richland, Washington.

Appendix A

Canister Storage Building – Additional Velocity Test Sheets

Appendix A

Canister Storage Building – Additional Velocity Test Sheets

This appendix contains data sheets for two additional velocity uniformity tests that were available through personal records.⁵ These additional tests were performed at slightly lower flow rates, with slightly higher coefficient of variation values.

⁵ Personal communication with J. Glissmeyer, Pacific Northwest National Laboratory, January 2016.

SNF Startup & Test Group Velocity Traverse Data

Site	CSB	Run No.	3 Traverse Fan 1	
Date	8/5/98	Injection point	NA	
Tester	Mathews and Dana	Fan Setting	NA	Hz
Stack Dia.	28 in.	Stack Temp	88.5 deg F	
Stack X-Area	615.8 in ²	Fan	WEST	
Elevation	714 ft above sea level	Center 2/3 from	4.70	to: 23.30
El. above disturbance	6.95 diameters	Points in Center 2/3	3	to: 10
Concentration, units	ppm SF ₆			

Traverse-->		East or Port #4				South or Port #3			
Trial ---->		1	2	3	Mean	1	2	3	Mean
Point	Depth, in.	Conc.	Conc.	Conc.	Conc.	Conc.	Conc.	Conc.	Conc.
1	1.00	2227.1	2265.2	2108.8	2200.4	2026.1	2026.1	2047.1	2033.1
2	1.88	2188.4	2265.2	2108.8	2187.5	2149.0	2067.8	2067.8	2094.9
3	3.30	2168.8	2188.4	2149.0	2168.7	2129.0	2168.8	2168.8	2155.5
4	4.96	2168.8	2227.1	2168.8	2188.2	2149.0	2168.8	2149.0	2155.6
5	7.00	2188.4	2227.1	2207.8	2207.8	2188.4	2168.8	2168.8	2175.3
6	9.97	2321.1	2265.2	2265.2	2283.8	2265.2	2265.2	2302.6	2277.7
Center	14.00	2446.7	2411.5	2411.5	2423.2	2446.7	2411.5	2393.7	2417.3
7	18.03	2498.6	2481.4	2498.6	2492.9	2429.2	2339.5	2429.2	2399.3
8	21.00	2498.6	2498.6	2532.6	2509.9	2411.5	2375.8	2375.8	2387.7
9	23.04	2515.6	2446.7	2515.6	2492.6	2375.8	2357.7	2357.7	2363.7
10	24.70	2464.1	2375.8	2411.5	2417.1	2375.8	2339.5	2357.7	2357.7
11	26.12	2481.4	2227.1	2168.8	2292.4	2265.2	2265.2	2302.6	2277.7
12	27.00	2004.8	2149.0	1939.8	2031.2	2149.0	2026.1	1917.6	2030.9
		West				North			

Traverse Averages ----->		2299.68				2240.49			
Average of all data		2270.08				Center 2/3			
Upper Limit 1.3 x mean		2951.11 Max Point				Mean	E/W	S/N	All
Lower Limit 0.7 x mean		1589.06 Min Point				2509.93	2353.82	2298.87	2326.34
Flow	9948 cfm					Std. Dev.	141.292	109.801	125.965
SNF Flow	9653.46 scfm					COV %	6.0	4.8	5.4

	Start	Finish	
Ambient Temp			F
Wind	SW 18 mph		
Record stack flow			fpm
Static pressure	0.08		in H2O
Ambient pressure	29.1		in. Hg
Ambient humidity	12.0		RH

Notes: _____

Instruments Used:

Manometer ID # 2572 Calibration due 6/19/99

Signed by Chris M Dana

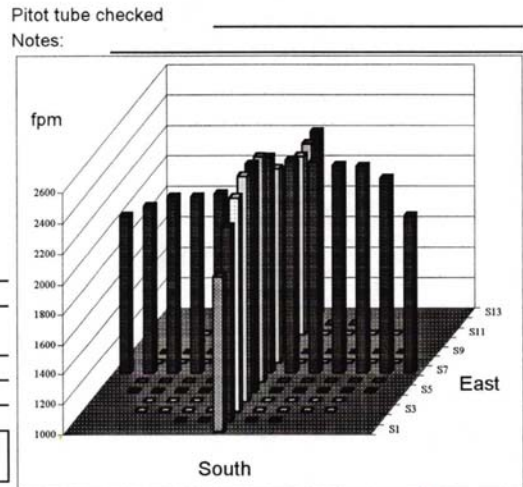

VELOCITY TRAVERSE DATA FORM

Site	Canister Storage Bldg	Run No	3 Traverse Fan 1	
Date	August 5, 1998	Stack Temp	88.5 Deg. F	WIND SW 18MPH
Tester	Dana & Mathews	Stack RH%	12 %	
Stack Dia	28.0 inch	Baro Press	29.06 in Hg	
Stack Cross Area	4.3 sq. ft.	Stack Static	0.08 in Water	
Elevation	714' Above Sea Level		0.01305 in Hg	
Elev. Above Disturbance	6.95 Pipe Dia.	Center 2/3 from	4.7 to	23.3
Units	Feet per minute	Points in Center 2/3	3 to	10

WEST FAN

AVG		CSB Stack Port #3				CSB Stack Port #4				
Traverse	Depth	Velocity	Velocity	Velocity	Velocity	Velocity	Velocity	Velocity		
1	1.00	2026.1	2026.1	2047.1	2227.1	2265.2	2108.8		2.1%	
2	1.88	2149.0	2067.8	2067.8	2188.4	2265.2	2108.8		6.7%	
2155	3	✓ 3.30	2129.0	2168.8	2168.8	2168.8	2188.4	2149.0	✓ 11.8%	
2155	4	✓ 4.96	2149.0	2168.8	2149.0	2168.8	2227.1	2168.8	✓ 17.7%	
2181	5	✓ 7.00	2188.4	2168.8	2168.8	2188.4	2227.1	2207.8	✓ 25.0%	
2277	6	✓ 9.97	2265.2	2265.2	2302.6	2321.1	2265.2	2265.2	✓ 35.6%	
2399	7	✓ 18.03	2429.2	2339.5	2429.2	2498.6	2481.4	2498.6	✓ 64.4%	
2387	8	✓ 21.00	2411.5	2375.8	2375.8	2498.6	2498.6	2532.6	✓ 75.0%	
2363	9	✓ 23.04	2375.8	2357.7	2357.7	2515.6	2446.7	2515.6	✓ 82.3%	
2357	10	✓ 24.70	2375.8	2339.5	2357.7	2464.1	2375.8	2411.5	✓ 88.2%	
	11	26.12	2265.2	2265.2	2302.6	2481.4	2227.1	2168.8	93.3%	
	12	27.00	2149.0	2026.1	1917.6	2004.8	2149.0	1939.8	97.9%	
									AVG	
	average of all data	2242.7	2214.1	2220.4	2310.5	2301.4	2256.3	2257.56		
	Center 2/3 data	2290.5	2273.0	2288.7	2353.0	2338.8	2343.6	2314.59		
2416	Centerpoint	14.00	2446.7	2411.5	2393.7	2446.7	2411.5	2411.5	2422	

Center 2/3 with centerpoint

Mean	2307.8	2288.4	2300.3	2363.4	2346.9	2351.2	2326.329
Std Dev.	126.142	97.648	109.043	152.061	120.702	154.537	126.689
COV%	5.5%	4.3%	4.7%	6.4%	5.1%	6.6%	5.4%

Flow Rate With 3 Traverses
9653.46 SCFM

~~Using First Traverse
9704.9 SCFM~~

Instruments Used	Cal Due	Performed by	<u>Chris Mathews</u>
Manometer ID # 2572	6/19/99	Reviewed By	_____

VELOCITY TRAVERSE INPUT FORM

Site Canister Storage Bldg Run No 3 Traverse Trial 1

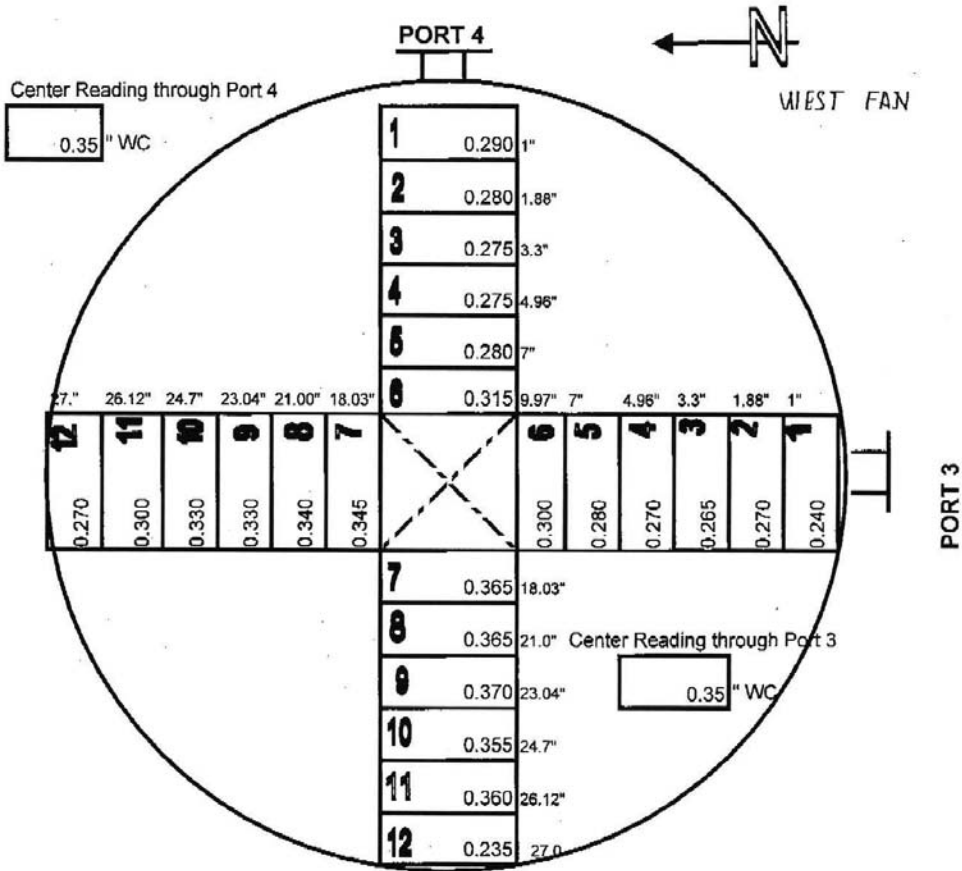

VELOCITY TRAVERSE INPUT FORM

Site Canister Storage Bldg

Run No 3 Traverse Trial **2**

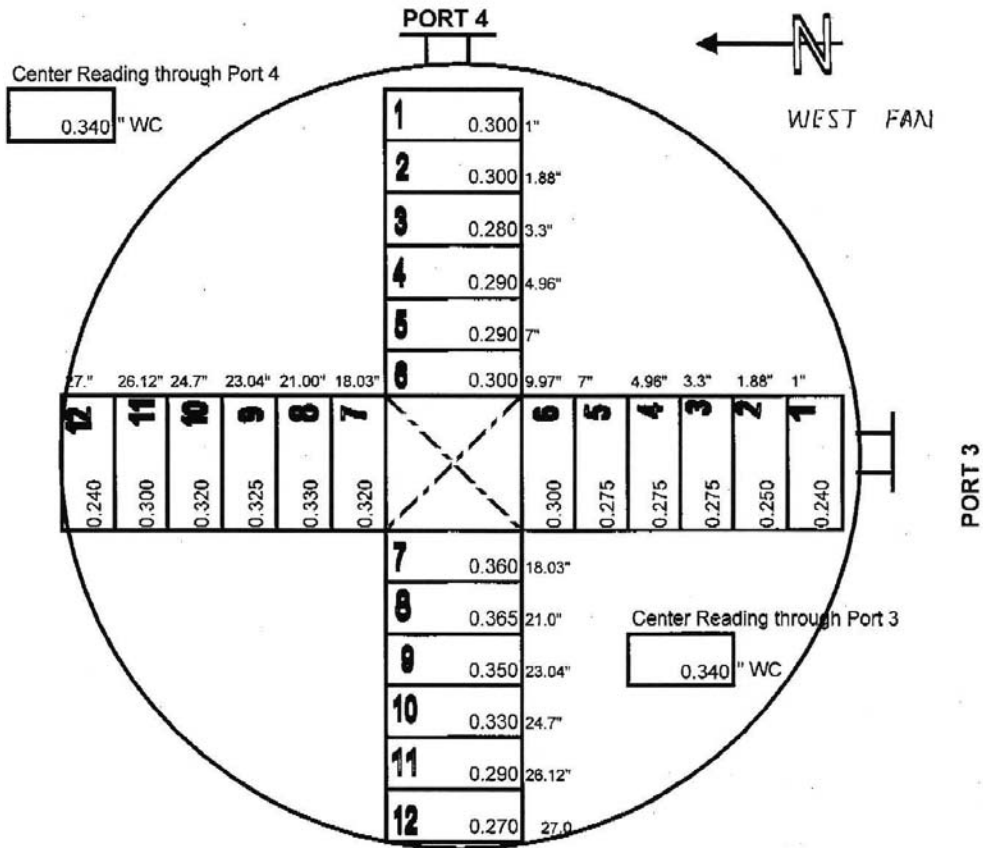

VELOCITY TRAVERSE INPUT FORM

Site Canister Storage Bldg

Run No 3 Traverse Trial 3

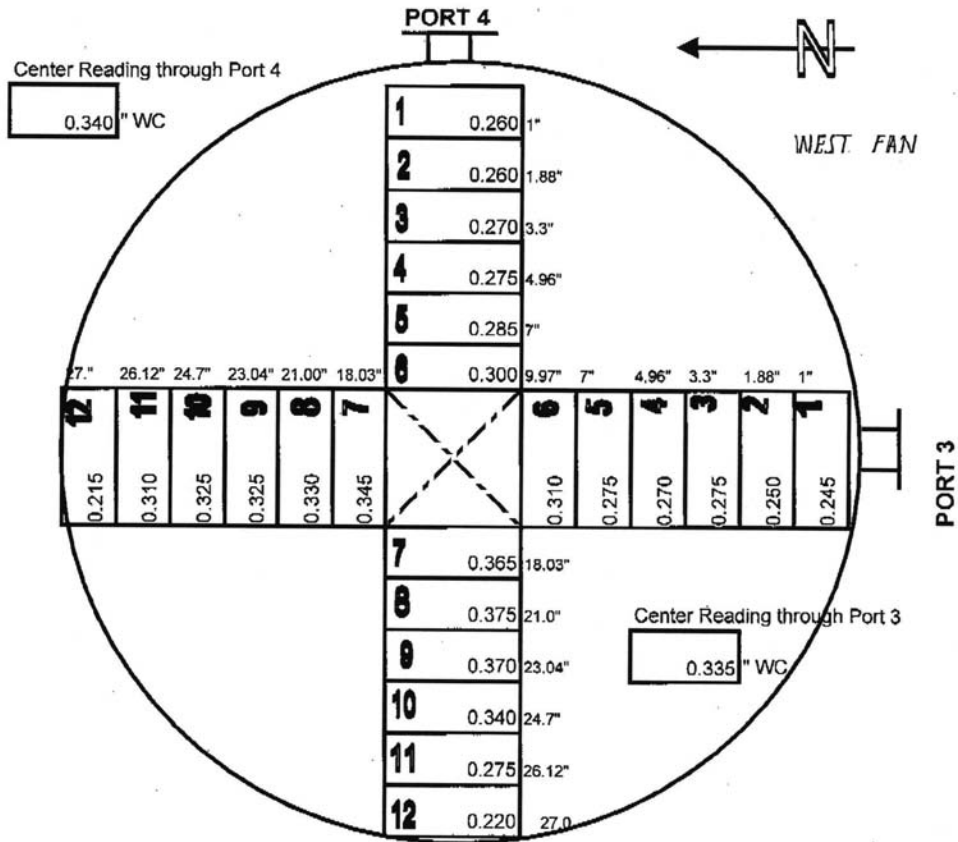

SNF Startup & Test Group Velocity Traverse Data

Site	CSB	Run No.	Trial 4
Date	8/6/98	Injection point	NA
Tester	Mathews and Dana	Fan Setting	NA Hz
Stack Dia.	28 in.	Stack Temp	81.9 deg F
Stack X-Area	615.8 in ²	Fan	EAST
Elevation	714 ft above sea level	Center 2/3 from	4.70 to: 23.30
El. above disturbance	6.95 diameters	Points in Center 2/3	3 to: 10
Concentration units	ppm SF ₆		

Traverse-->		East or Port #4				South or Port #3			
Trial -->		1	2	3	Mean	1	2	3	Mean
Point	Depth, in.	Conc.	Conc.	Conc.	Conc.	Conc.	Conc.	Conc.	Conc.
1	1.00	2488.4	2420.3	2488.4	2465.7	1962.0	1962.0	1962.0	1962.0
2	1.88	2554.8	2488.4	2521.8	2521.7	1983.2	2004.2	1962.0	1983.1
3	3.30	2587.4	2554.8	2587.4	2576.5	2420.3	2045.5	2004.2	2156.7
4	4.96	2587.4	2587.4	2587.4	2587.4	2086.0	2086.0	2125.7	2099.2
5	7.00	2587.4	2619.5	2587.4	2598.1	2240.7	2222.0	2240.7	2234.5
6	9.97	2554.8	2587.4	2521.8	2554.7	2350.1	2350.1	2277.8	2326.0
Center	14.00	2488.4	2521.8	2385.4	2465.2	2521.8	2454.6	2402.9	2459.8
7	18.03	2296.1	2240.7	2277.8	2271.5	2488.4	2454.6	2420.3	2454.4
8	21.00	2164.7	2164.7	2164.7	2164.7	2420.3	2420.3	2488.4	2443.0
9	23.04	2145.3	2086.0	2164.7	2132.0	2454.6	2420.3	2454.6	2443.2
10	24.70	2145.3	2086.0	2125.7	2119.0	2402.9	2385.4	2420.3	2402.9
11	26.12	2106.0	2086.0	2086.0	2092.7	2332.2	2277.8	2314.2	2308.1
12	27.00	1735.7	1475.0	1636.4	1615.7	1789.2	1783.2	1829.5	1800.6
		West				North			

Traverse Averages ----->		2320.37				2236.42			
Average of all data		2278.40				Center 2/3	E/W	S/N	All
Upper Limit 1.3 x mean		2961.92 Max Point				Mean	2385.46	2335.51	2360.49
Lower Limit 0.7 x mean		1594.88 Min Point				Std. Dev.	210.491	139.363	175.072
Flow	10094 cfm					COV %	8.8	6.0	7.4
SNF Flow	9676.60 scfm								

	Start	Finish	
Ambient Temp			F
Wind	none		
Record stack flow			fpm
Static pressure	0.7		in H2O
Ambient pressure	29.2		in. Hg
Ambient humidity	31.0		RH

Notes: _____

Instruments Used: _____

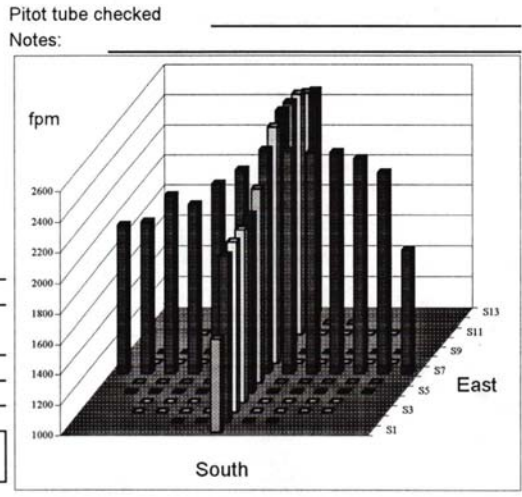

VELOCITY TRAVERSE DATA FORM

Site	Canister Storage Bldg	Run No	Trail 4
Date	August 6, 1998	Stack Temp	81.9 Deg. F <i>NO WIND</i>
Tester	Dana and Mathews	Stack RH%	31%
Stack Dia	28.0 inch	Baro Press	29.24 in Hg
Stack Cross Area	4.3 sq. ft.	Stack Static	0.7 in Water
Elevation	714' Above Sea Level		0.11419 in Hg
Elev. Above Disturbance	6.95 Pipe Dia.	Center 2/3 from	4.7 to 23.3
Units	Feet per minute	Points in Center 2/3	3 to 10

EXIT FAN

AVG.	Traverse	Depth	Velocity	Velocity	Velocity	Velocity	Velocity	Velocity	AVG.
	1	1.00							2.1%
	2	1.88							6.7%
2156	3	3.30	2420.3	2045.5	2004.2	2587.4	2554.8	2587.4	11.8% 2576
2099	4	4.96	2086.0	2086.0	2125.7	2587.4	2587.4	2587.4	17.7% 2587
2234	5	7.00	2240.7	2222.0	2240.7	2587.4	2610.5	2587.4	25.0% 2597
2325	6	9.97	2350.1	2350.1	2277.8	2554.8	2587.4	2521.8	35.6% 2554
2454	7	18.03	2488.4	2454.6	2420.3	2296.1	2240.7	2277.8	64.4% 2271
2442	8	21.00	2420.3	2420.3	2488.4	2164.7	2164.7	2164.7	75.0% 2164
2442	9	23.04	2454.6	2420.3	2454.6	2145.3	2086.0	2164.7	82.3% 2151
2402	10	24.70	2402.9	2385.4	2420.3	2145.3	2086.0	2125.7	88.2% 2113
	11	26.12							93.3%
	12	27.00							97.9%

average of all data	2243.7	2200.9	2208.3	2329.4	2283.0	2312.5	2262.97
Center 2/3 data	2357.9	2298.0	2304.0	2383.5	2365.8	2377.1	2347.73

~~2459~~ Centerpoint 14.00 ~~2521.8~~ ~~2454.6~~ ~~2402.9~~ ~~2488.4~~ ~~2521.8~~ ~~2385.4~~ ~~2464~~

Center 2/3 with centerpoint

Mean	2376.1	2315.4	2315.0	2395.2	2383.1	2378.0	2360.483
Std Dev.	135.925	158.528	165.378	203.950	232.530	199.025	182.556
COV%	5.7%	6.8%	7.1%	8.5%	9.8%	8.4%	7.7%

Flow Rate With 3 Traverses
9676.60 SCFM

Using First Traverse
9777.4 SCFM

Instruments Used _____ Cal Due _____ Performed by _____
 _____ Reviewed By _____

VELOCITY TRAVERSE INPUT FORM

Site Canister Storage Bldg

Run No Trail 4 Trial 1

EAST FAN

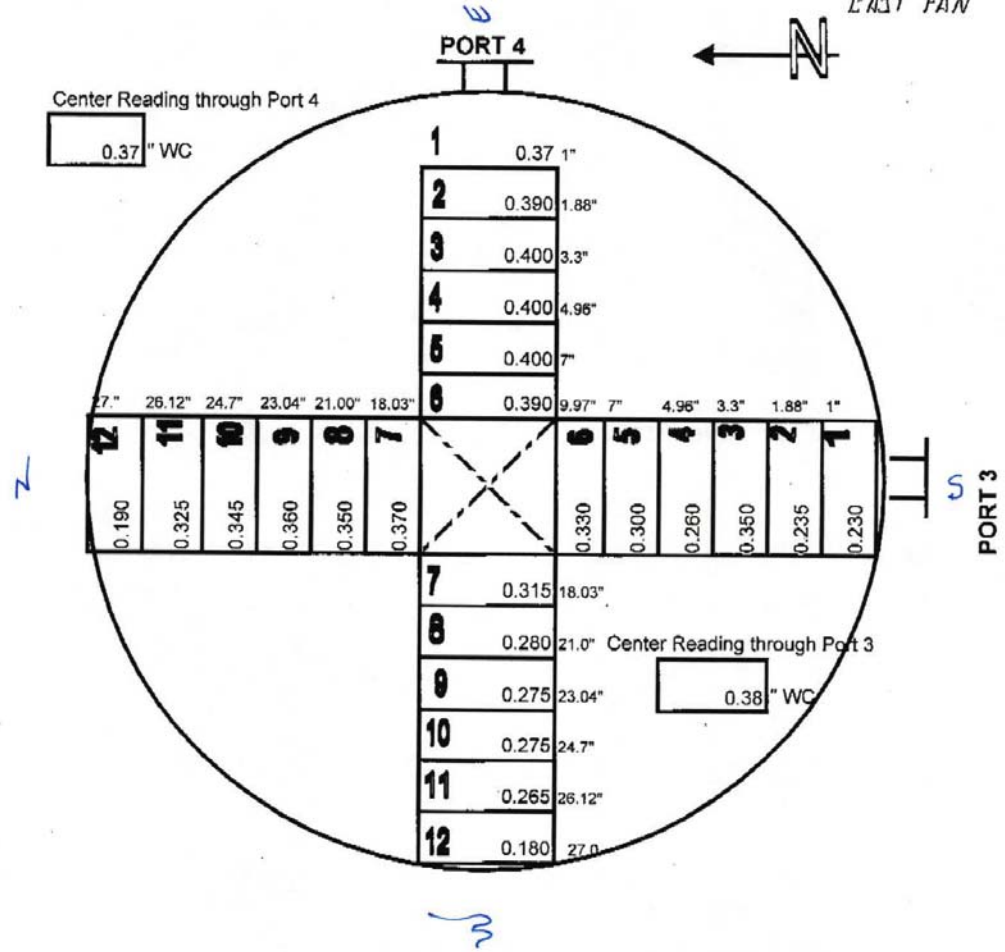

VELOCITY TRAVERSE INPUT FORM

Site Canister Storage Bldg Run No Trail 4 Trial **2**

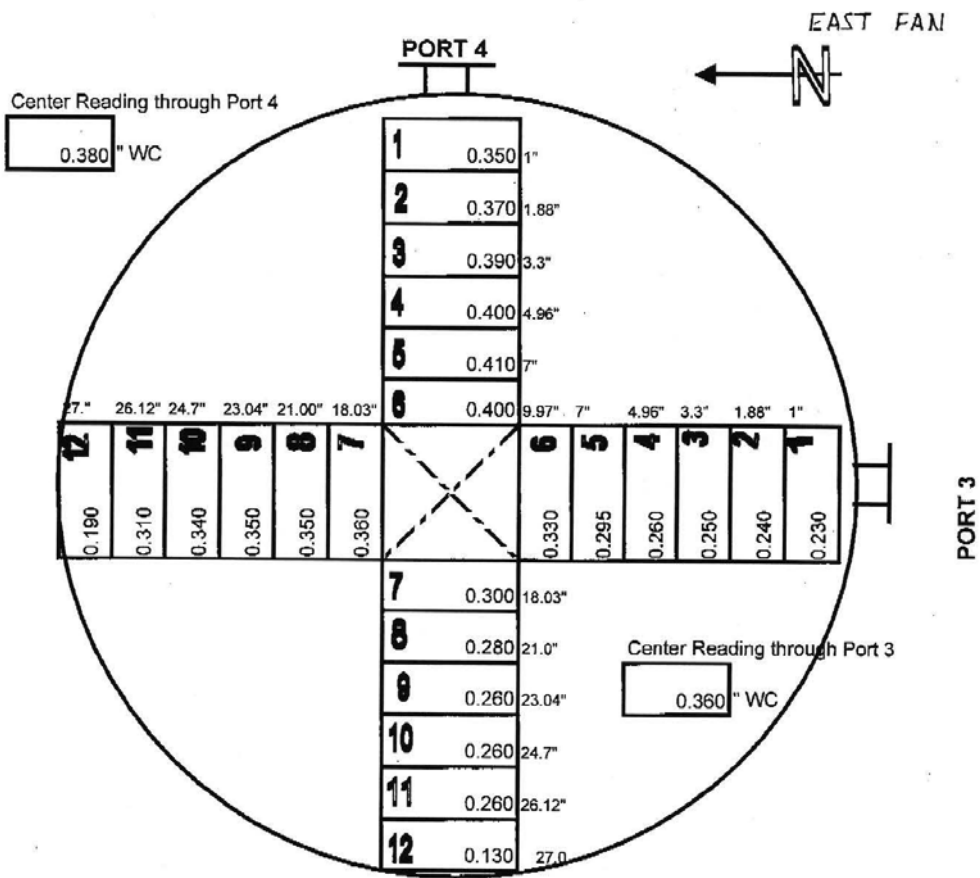

VELOCITY TRAVERSE INPUT FORM

Site Canister Storage Bldg Run No Trail 4 Trial 3
 EAST FAN

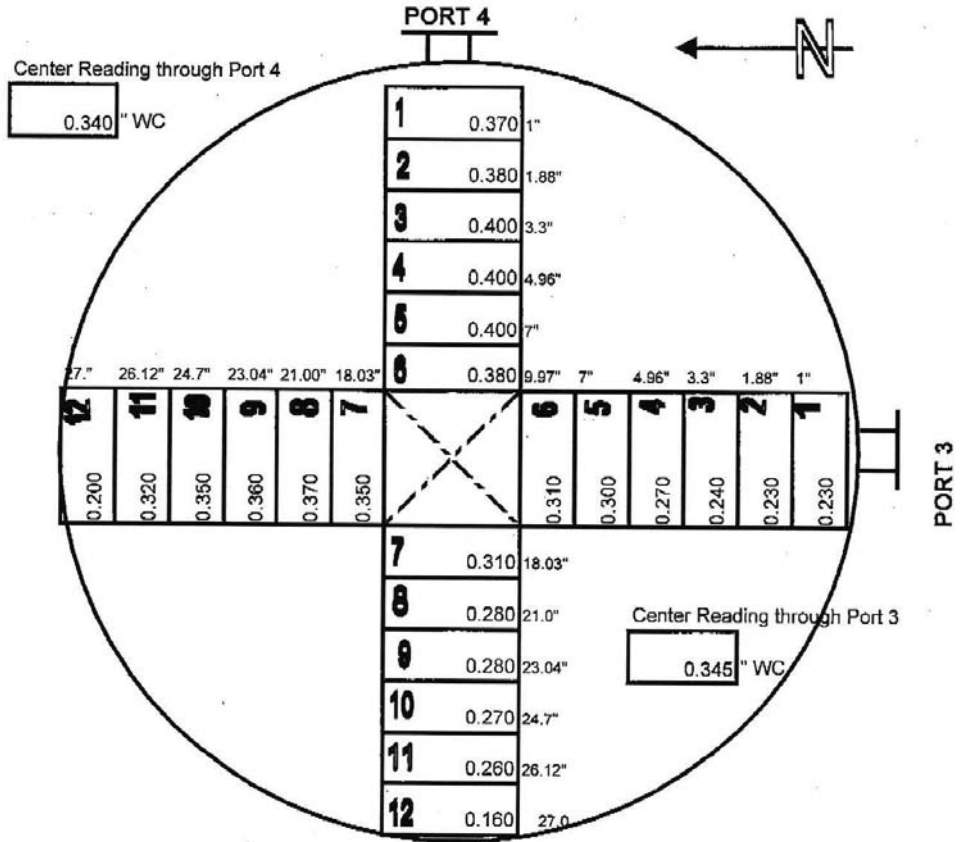

Appendix B

Geometries of More Complex Stacks

Appendix B

Geometries of More Complex Stacks

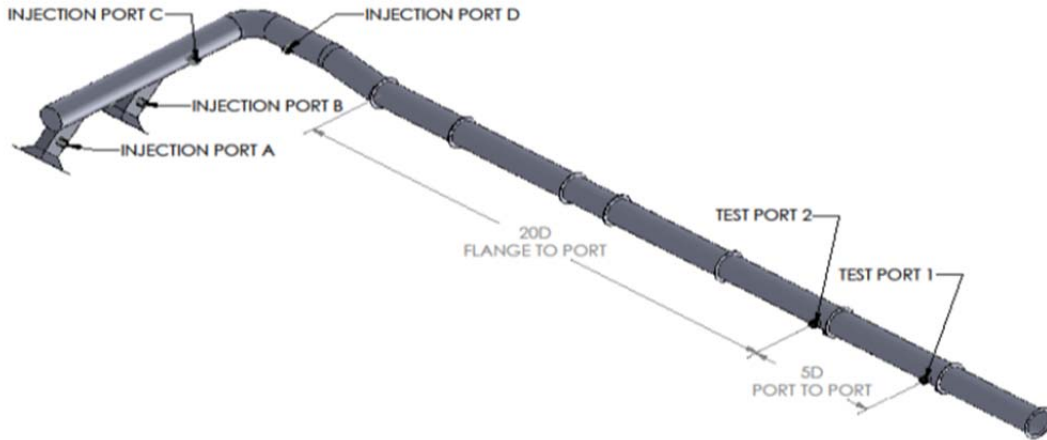

HV-S1 Scale Model

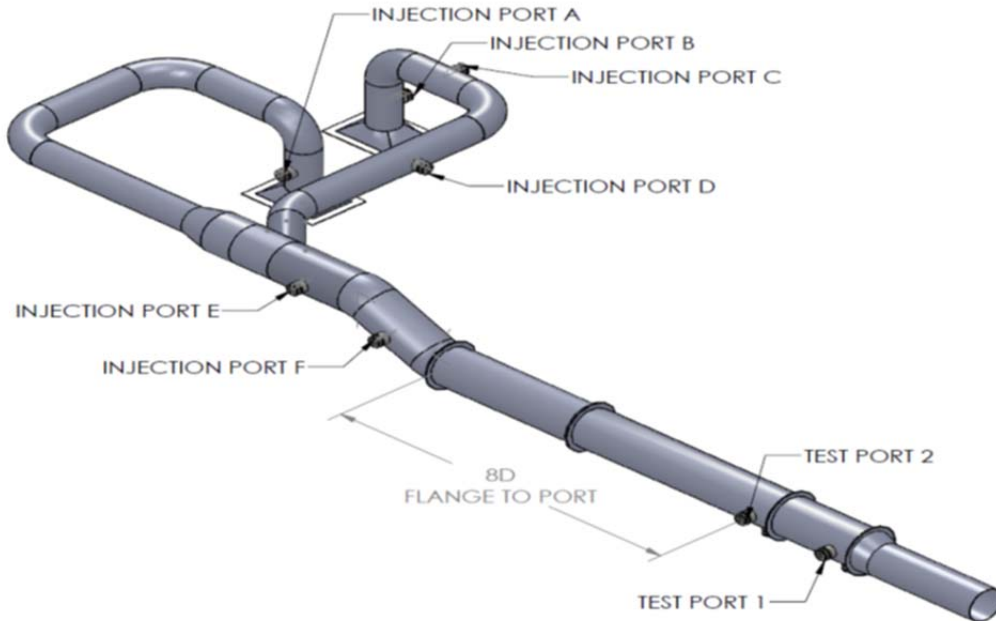

HV-S2 Scale Model

C3V CANISTER TEST LAYOUT

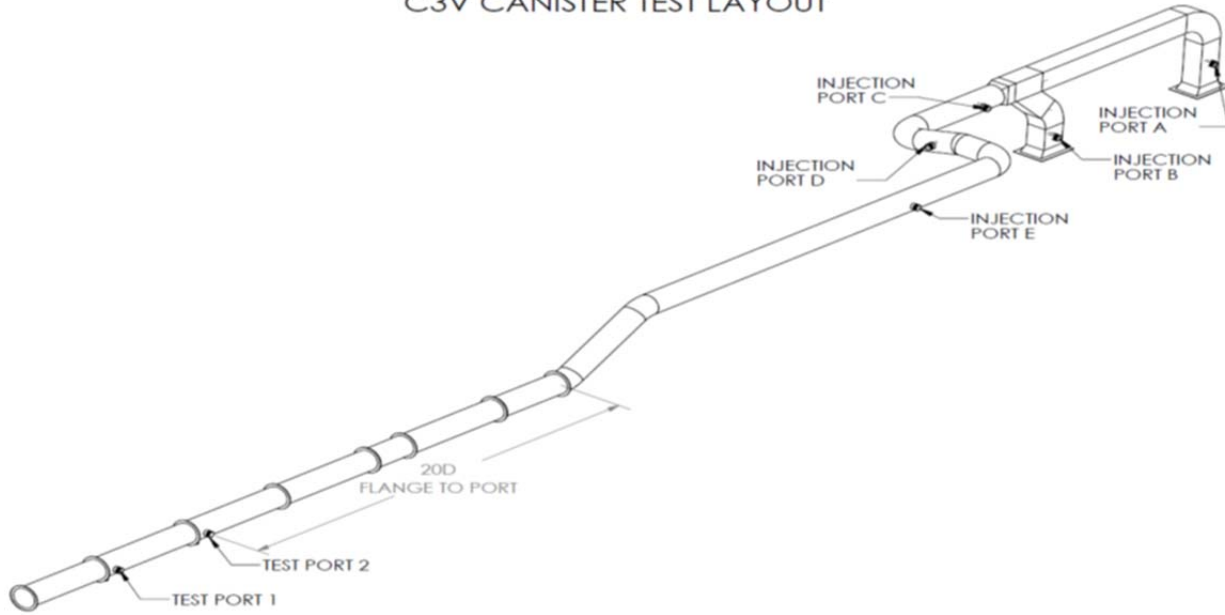

IHLW-S1 Scale Model

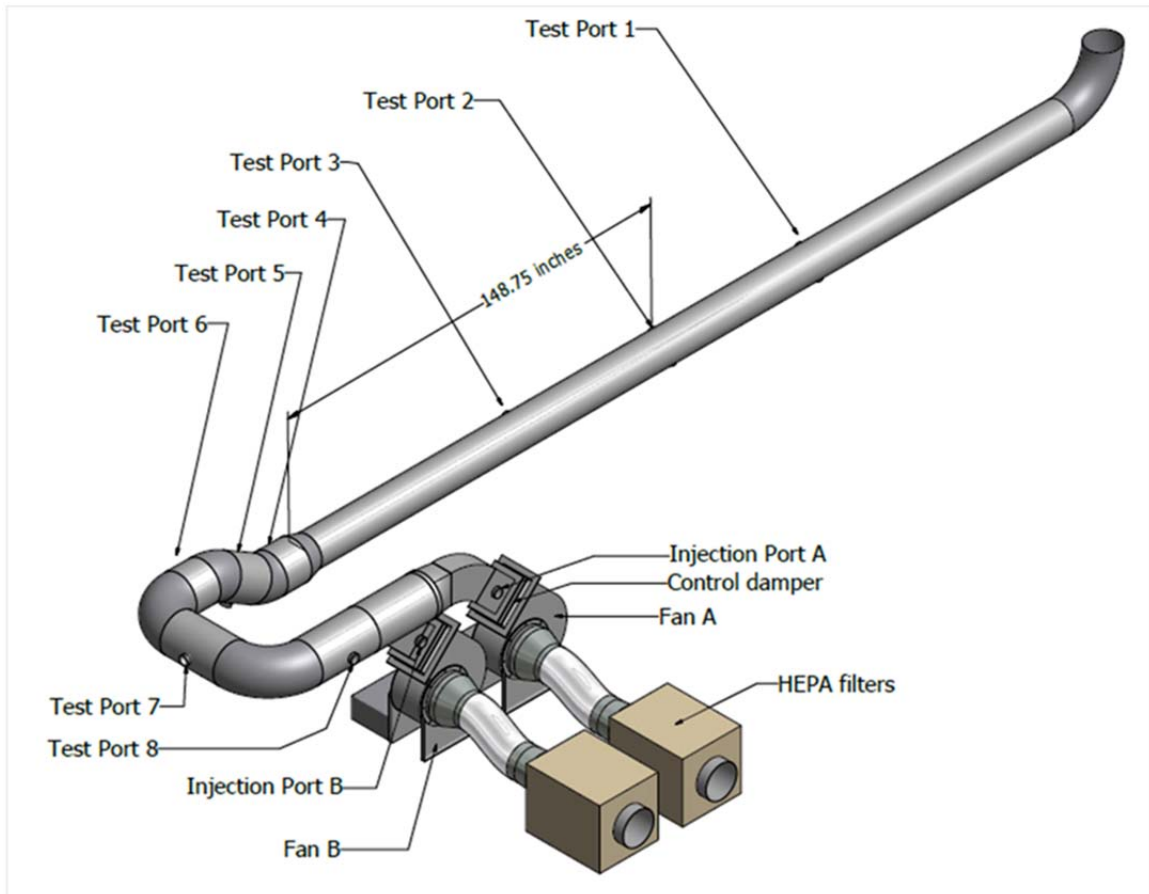

LV-S1 Scale Model

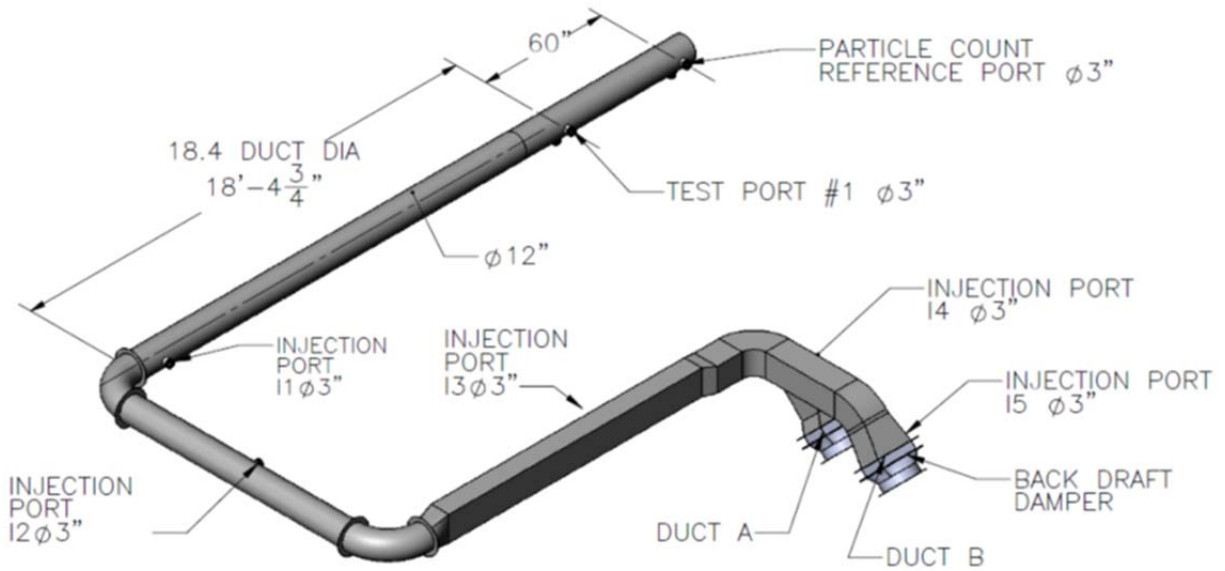

LV-S2 Scale Model

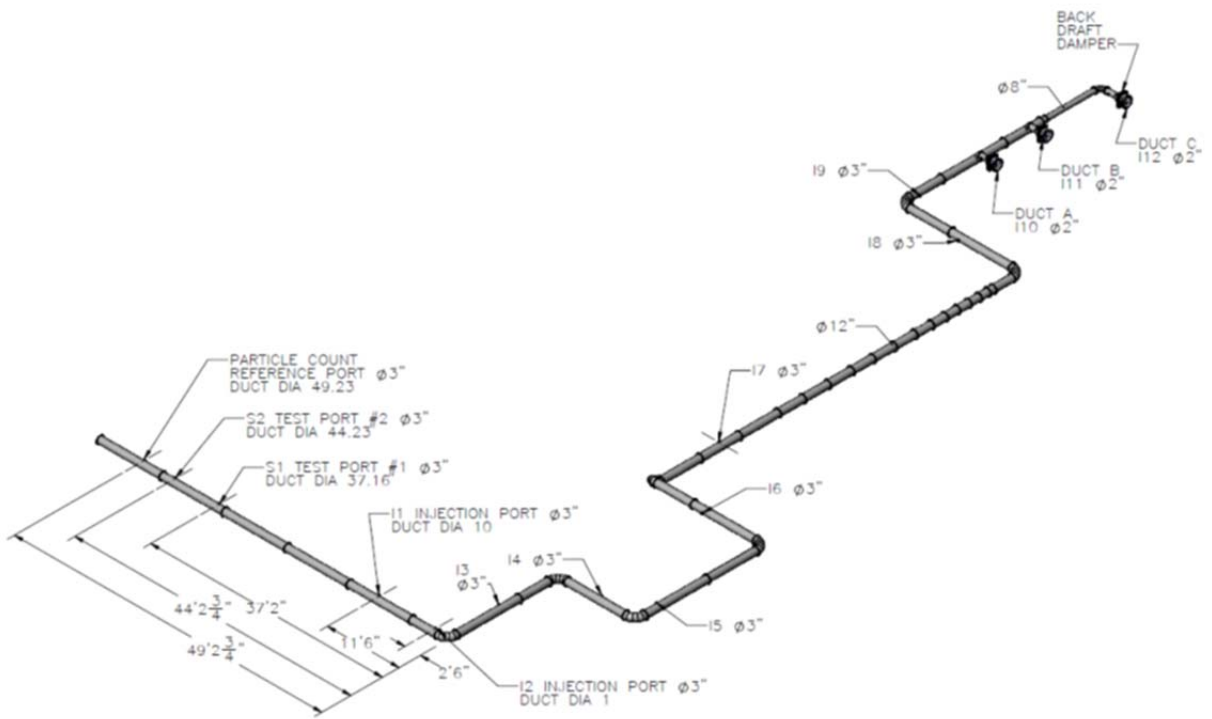

LV-S3 Scale Model

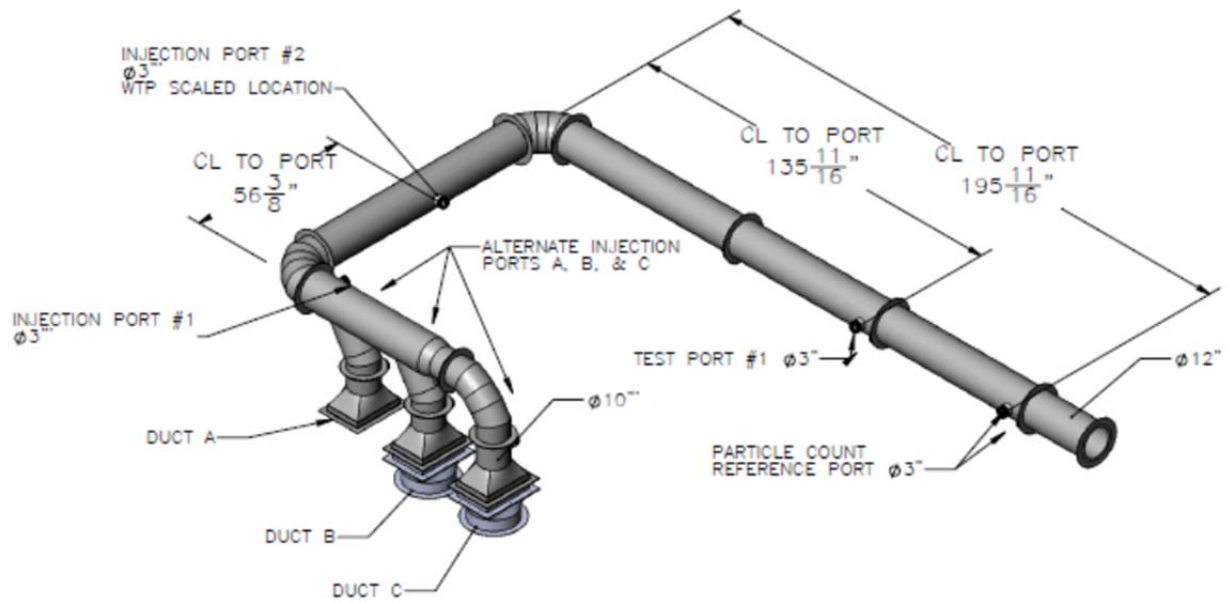

LB-S1 Scale Model

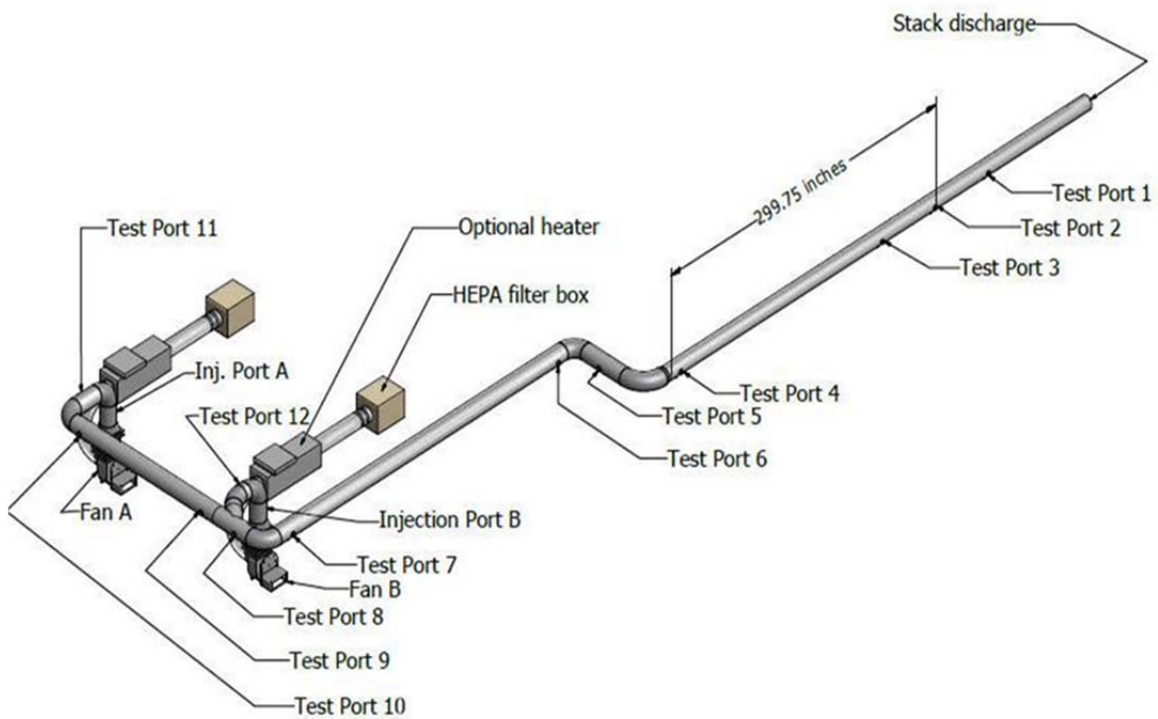

LB-S2 Scale Model

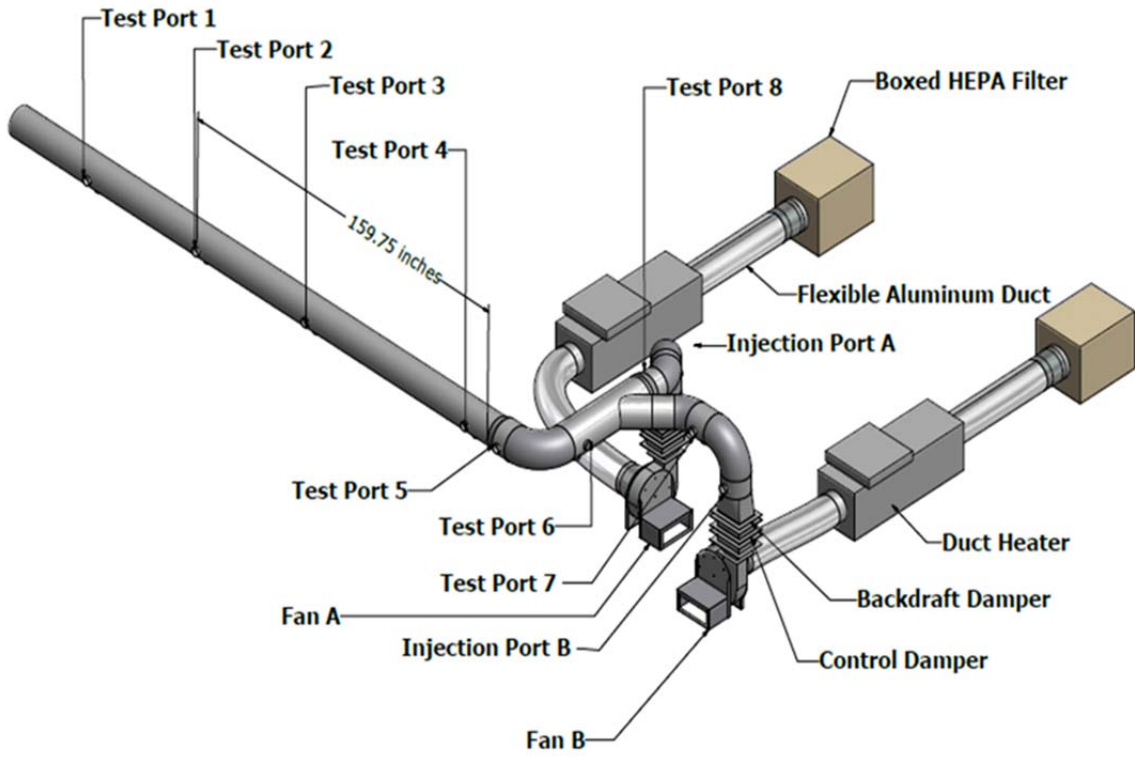

LB-C2 Scale Model

Appendix C

Test Results of More Complex Stacks

Appendix C

Test Results of More Complex Stacks

C.1 Velocity Uniformity Test Results

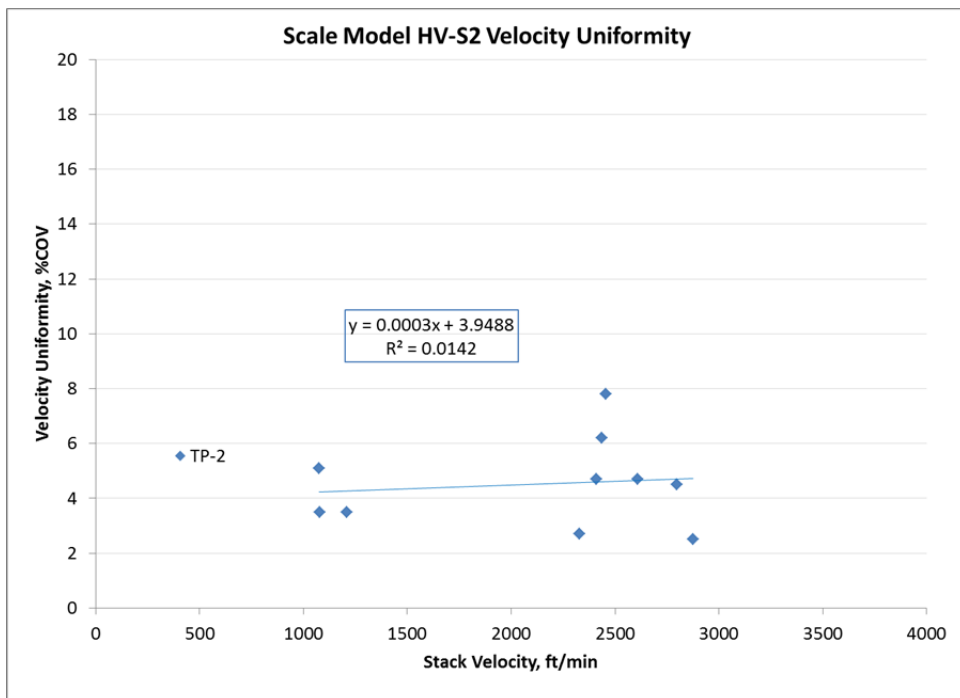
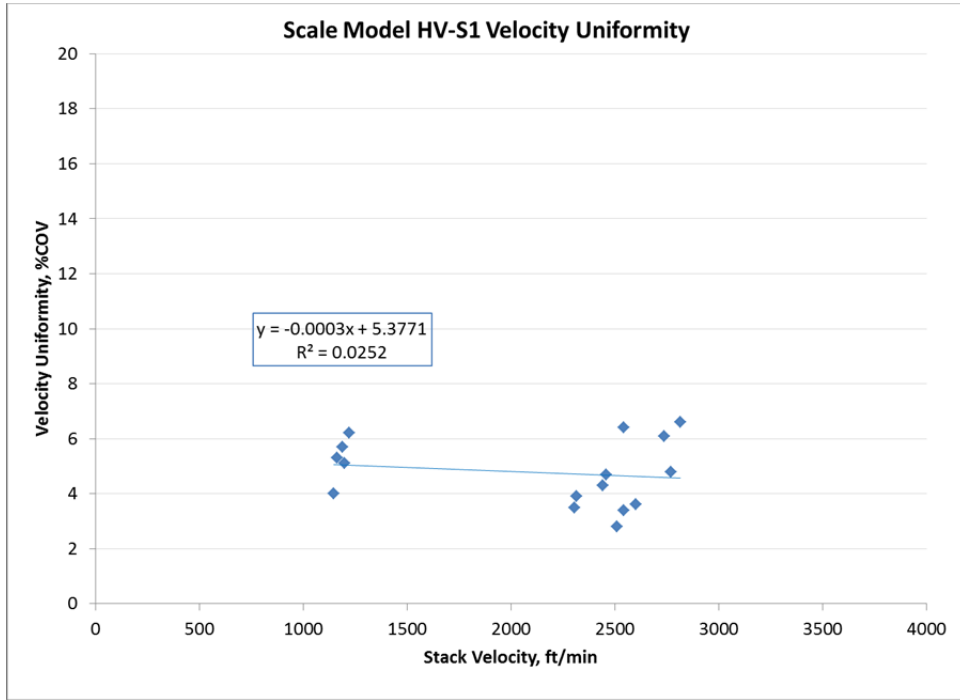

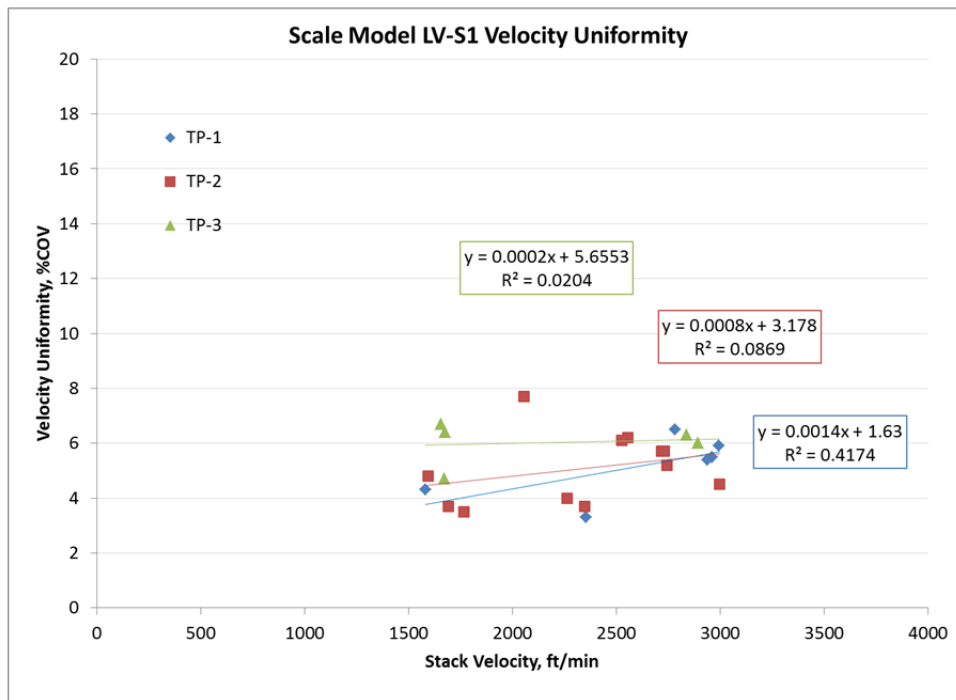
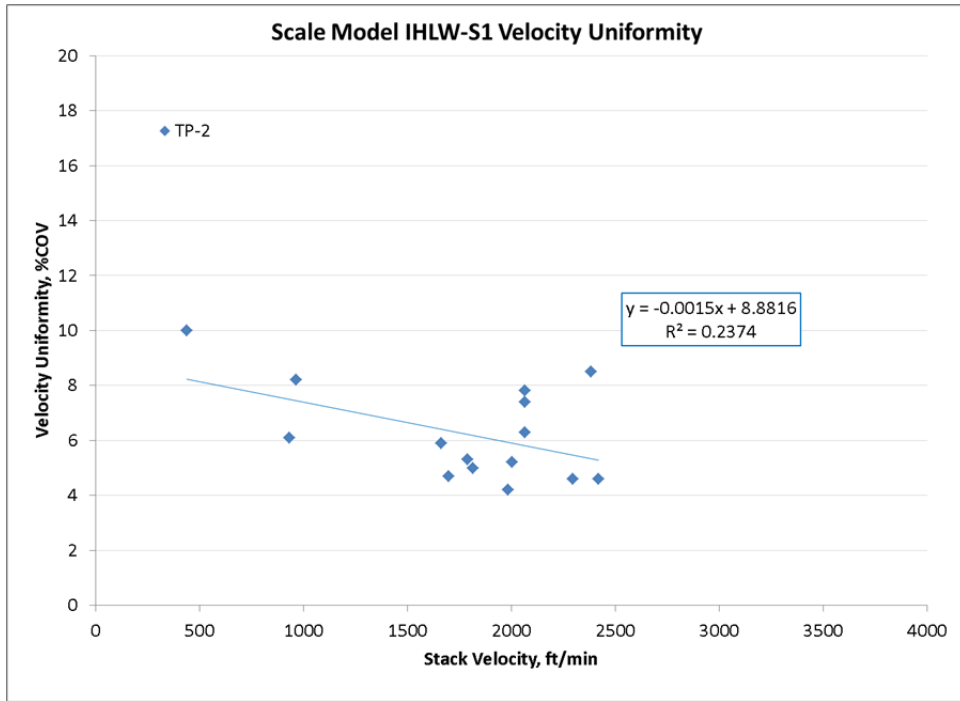

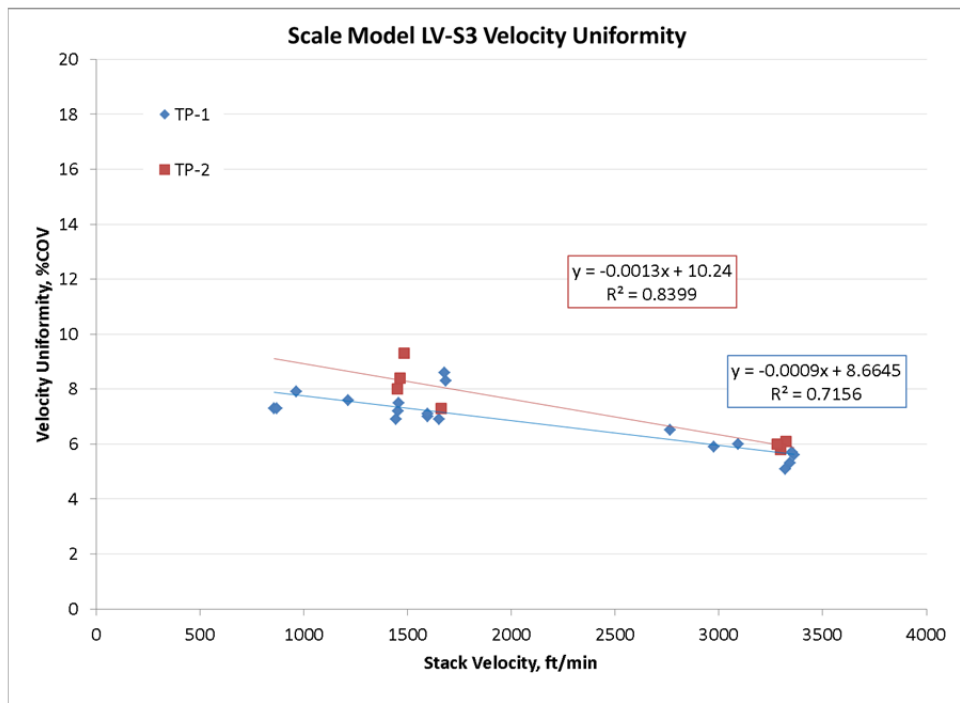
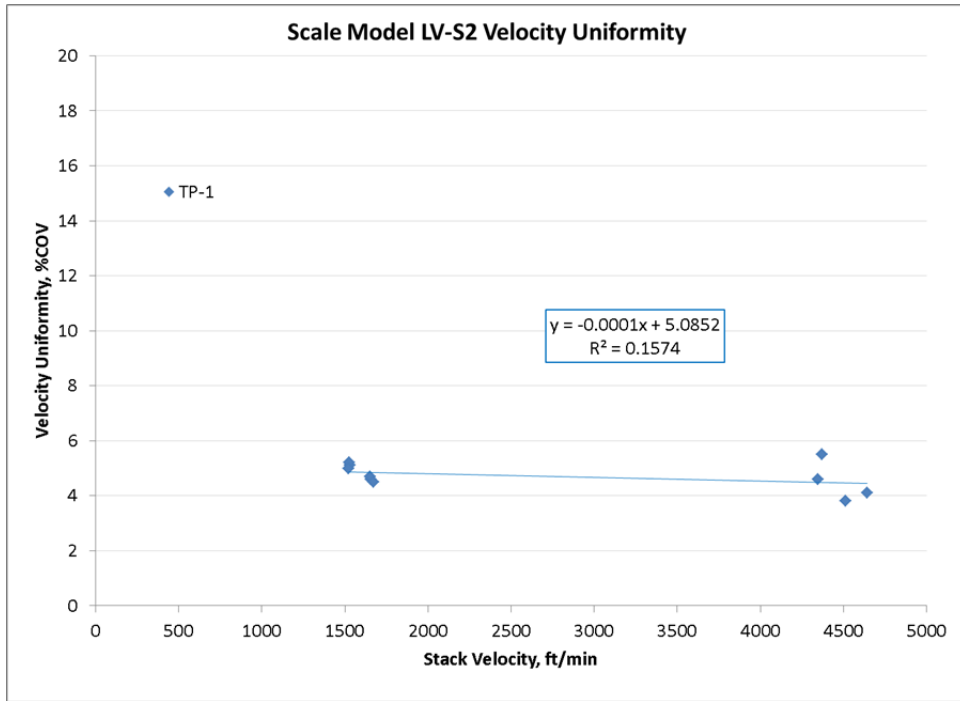

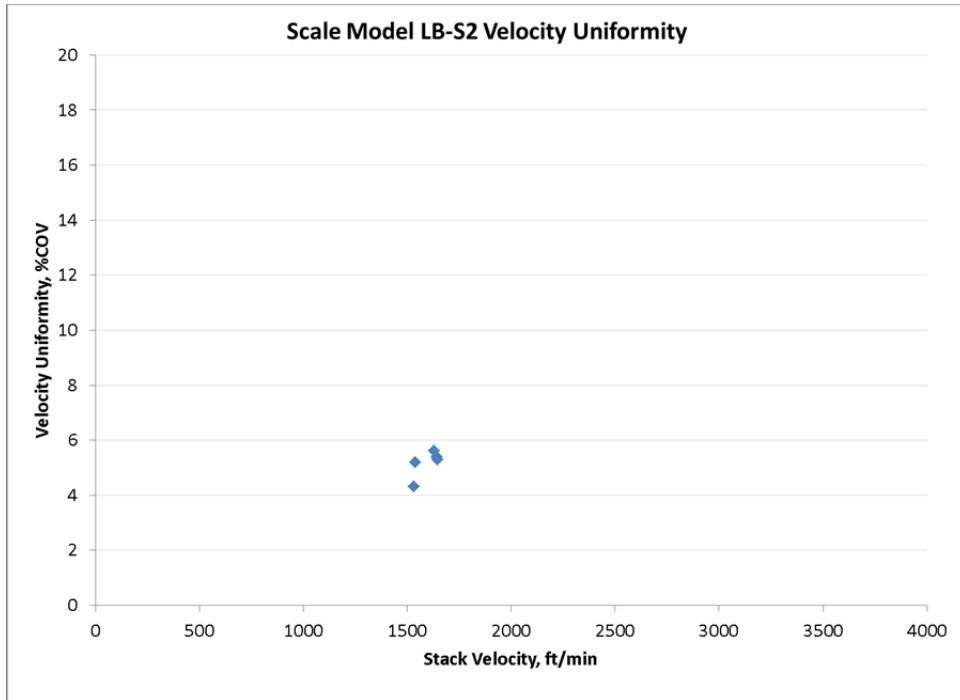
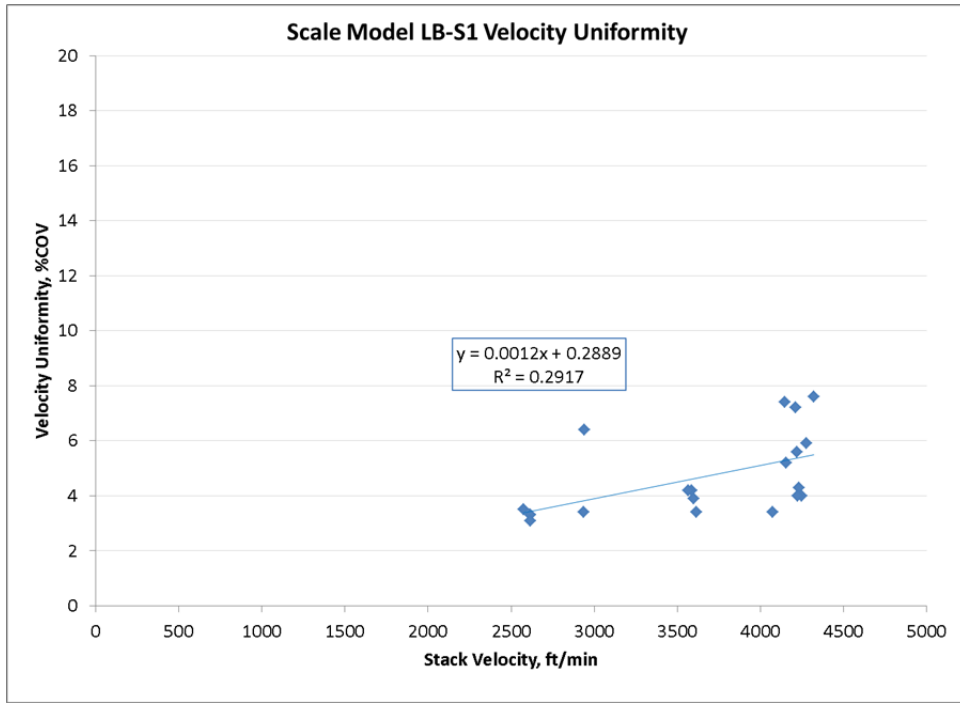

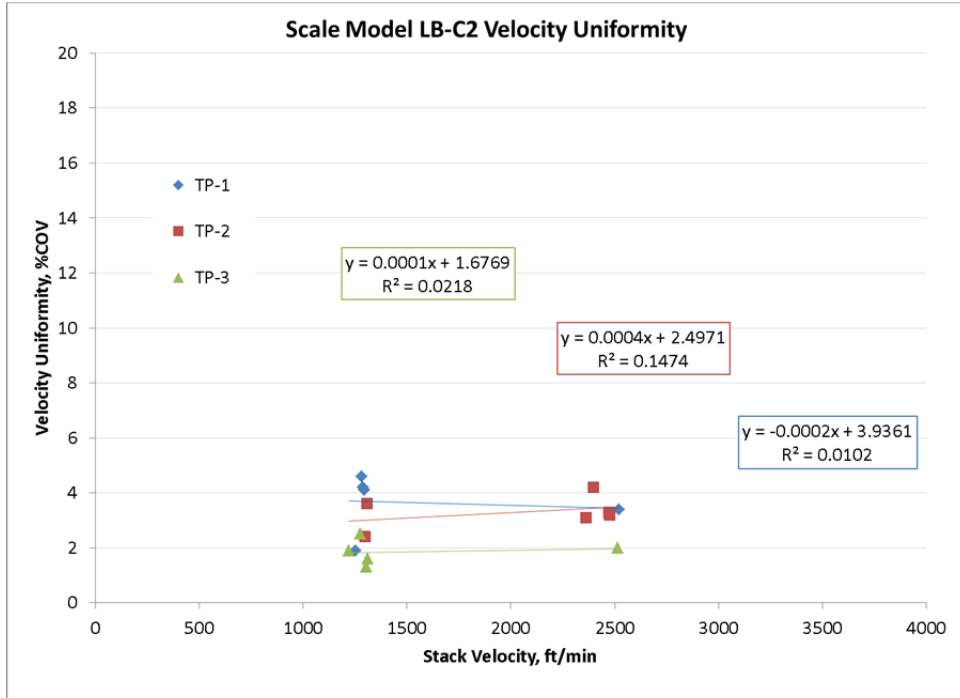

Stack	Slope Sign	Slope Value	R ²	N
HV-S1	Negative	0.3%/1000 fpm	0.03	16
HV-S2	Positive	0.3%/1000 fpm	0.01	10
IHLW-S1	Negative	1.5%/1000 fpm	0.24	15
LV-S1 (TP-2)	Positive	0.8%/1000 fpm	0.09	12
LV-S2	Negative	0.1%/1000 fpm	0.16	10
LV-S3 (TP-1)	Negative	0.9%/1000 fpm	0.72	19
LB-S1	Positive	1.2%/1000 fpm	0.29	21
LB-S2	NA	NA	NA	NA
LB-C2 (TP-2)	Positive	0.4%/1000 fpm	0.15	6

C.2 Flow Angle Test Results

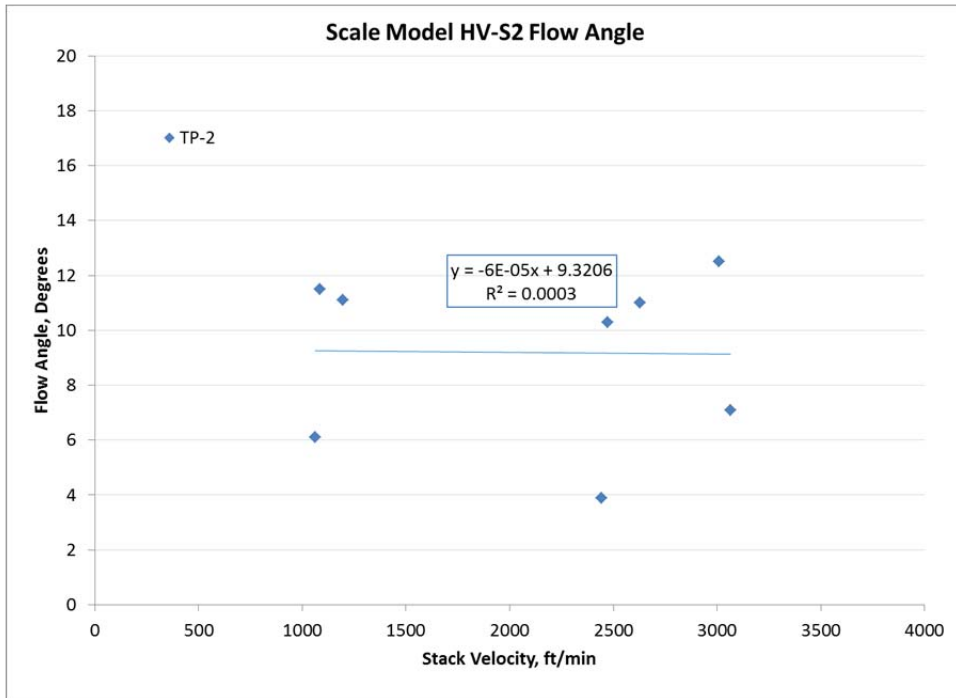
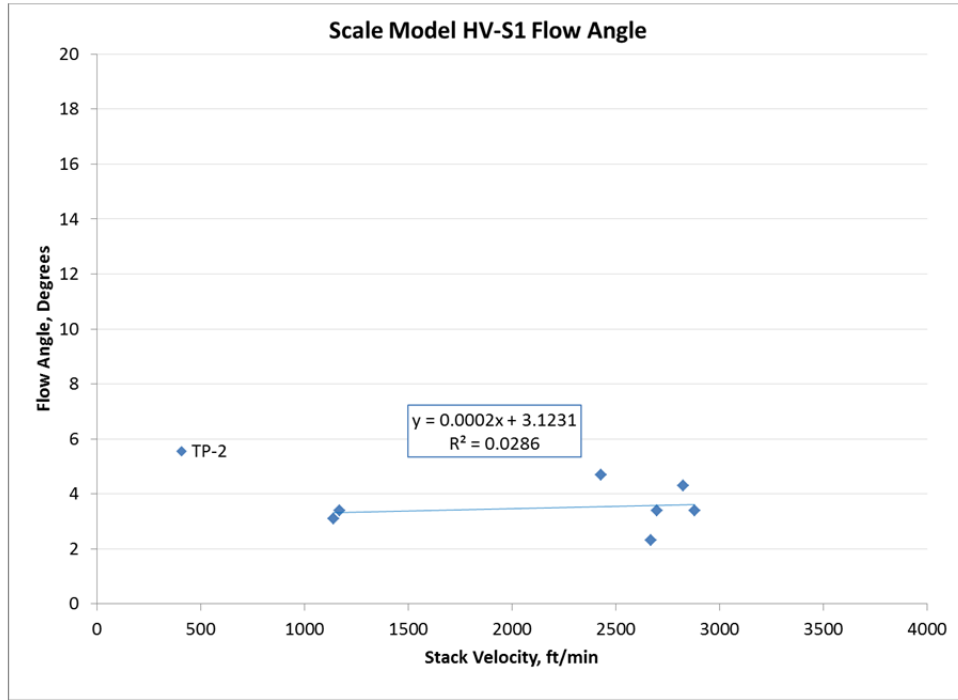

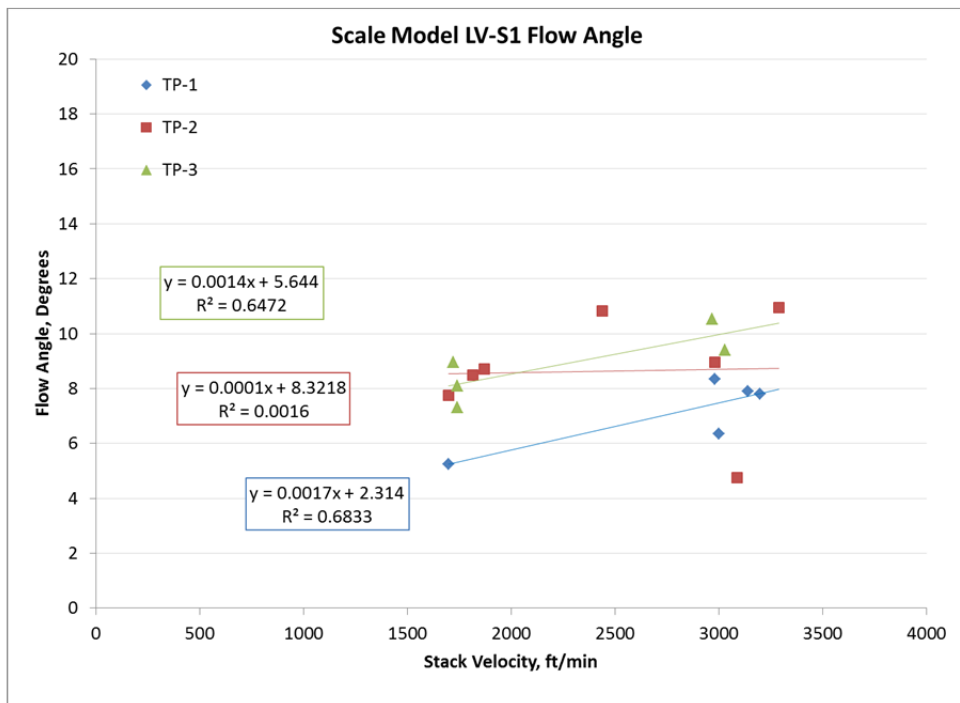
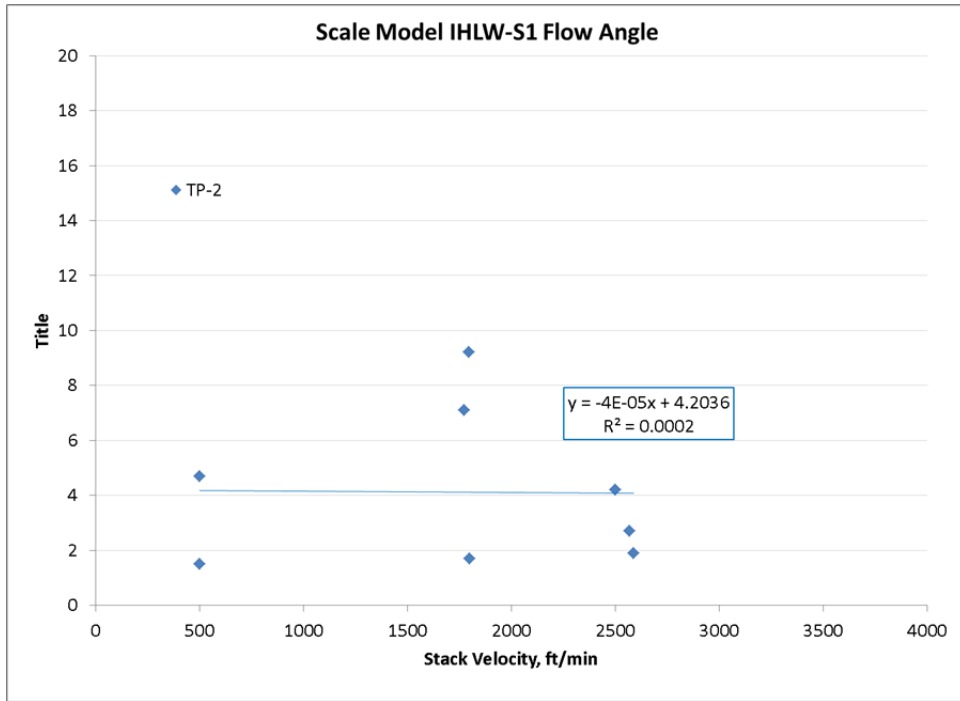

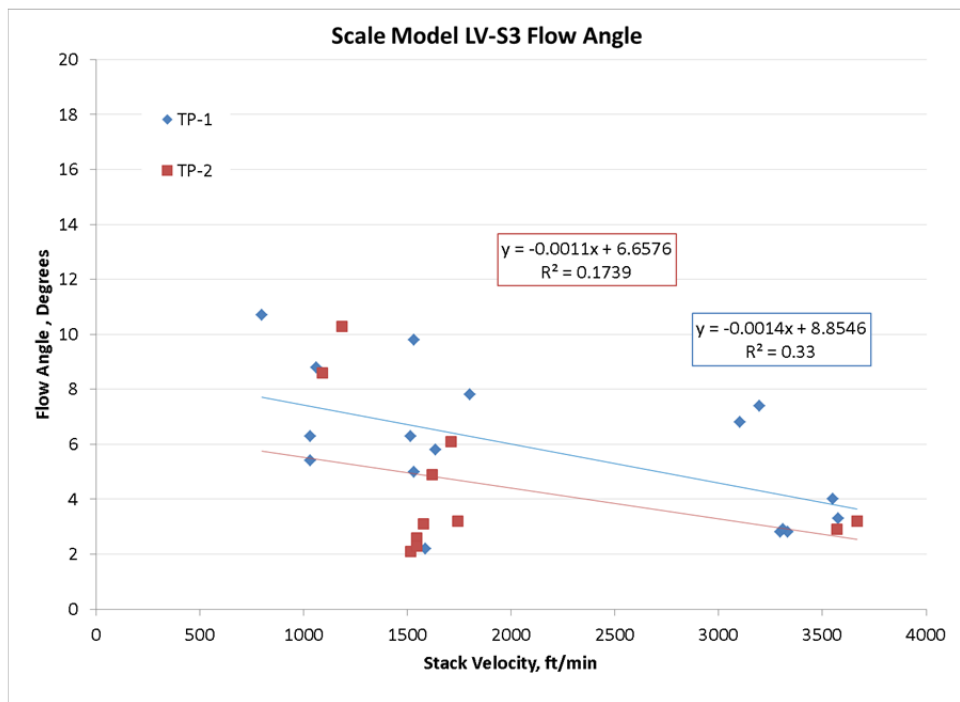
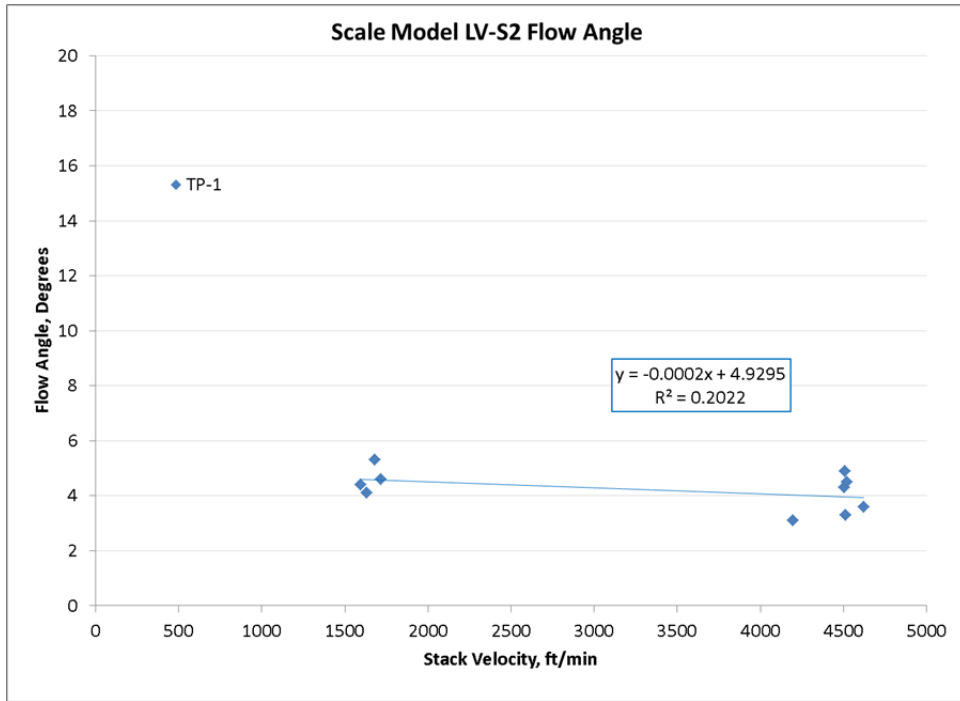

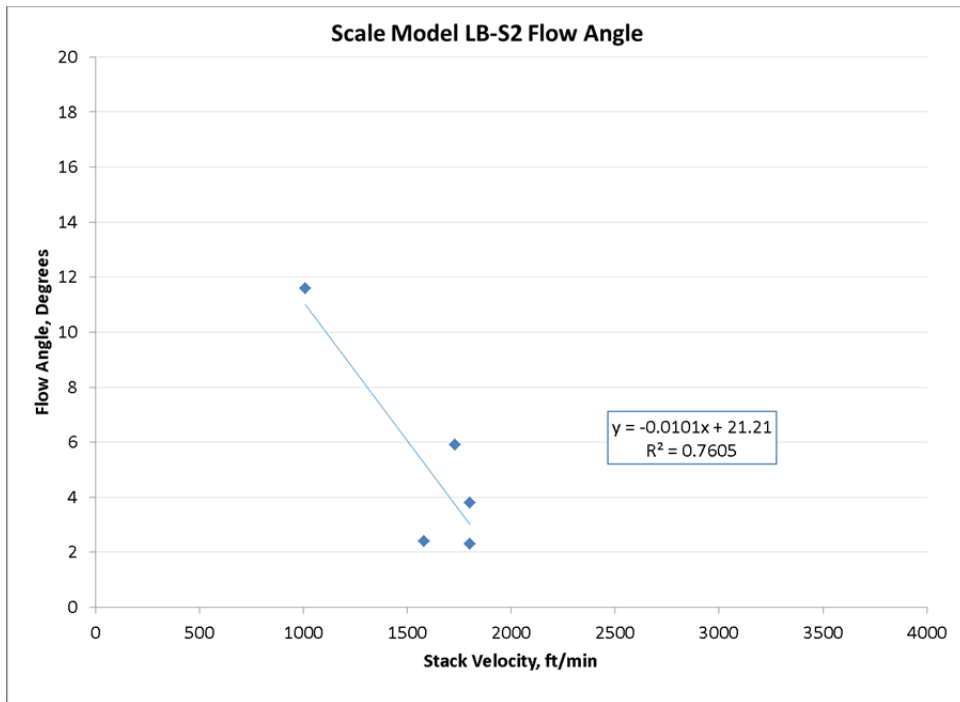
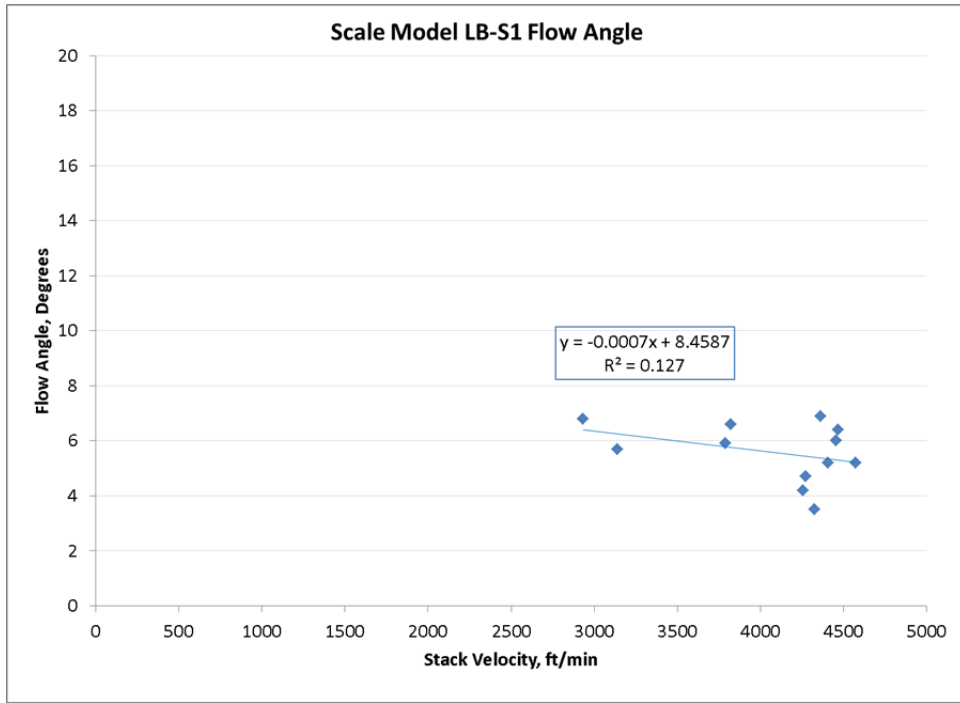

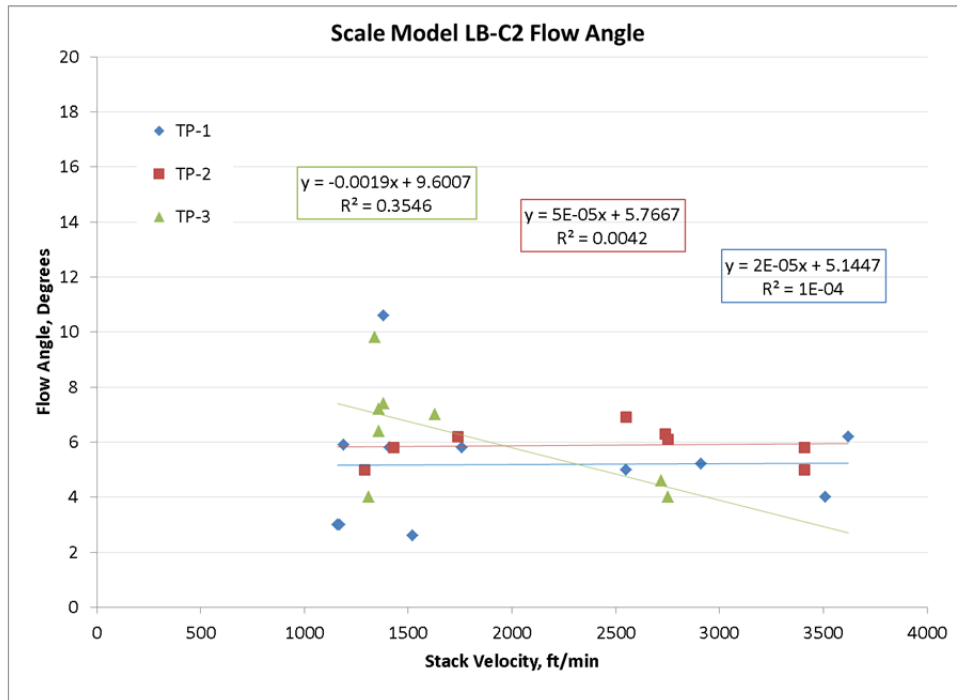

Stack	Slope Sign	Slope Value	R ²	N
HV-S1	Positive	0.02°/1000 fpm	0.03	7
HV-S2	Negative	<0.1°/1000 fpm	<0.01	8
IHLW-S1	Negative	<0.1°/1000 fpm	<0.01	8
LV-S1 (TP-3)	Positive	1.4°/1000 fpm	0.65	5
LV-S2	Negative	0.2°/1000 fpm	0.20	10
LV-S3 (TP-1)	Negative	1.1°/1000 fpm	0.17	17
LB-S1	Negative	0.7°/1000 fpm	0.13	12
LB-S2	Negative	10.1°/1000 fpm	0.76	5
LB-C2 (TP-2)	Negative	<0.1°/1000 fpm	<0.01	8

C.3 Gaseous Tracer Uniformity Test Results

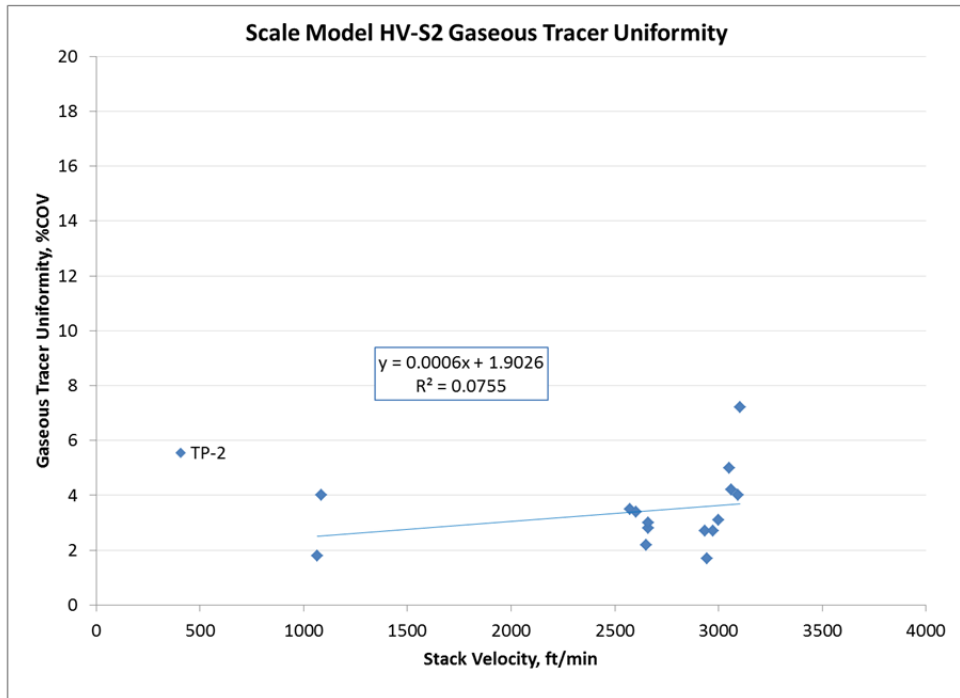
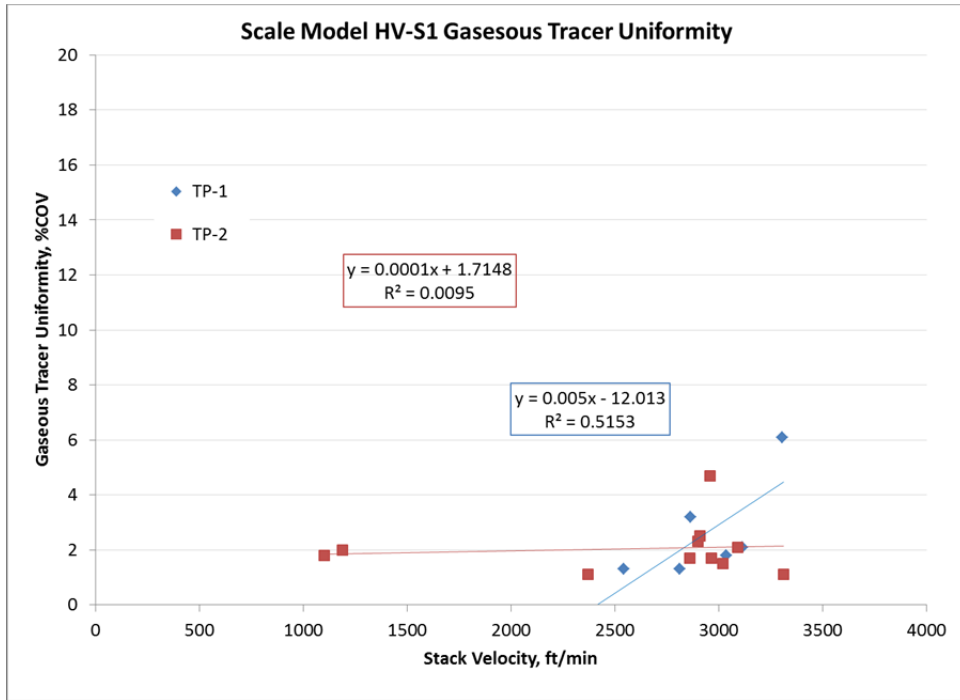

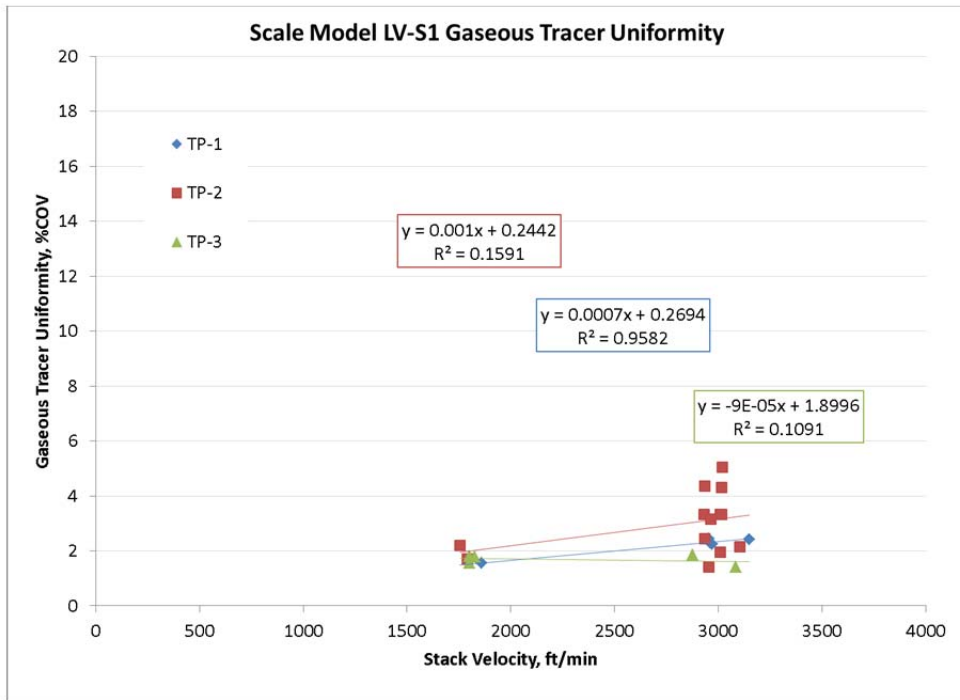
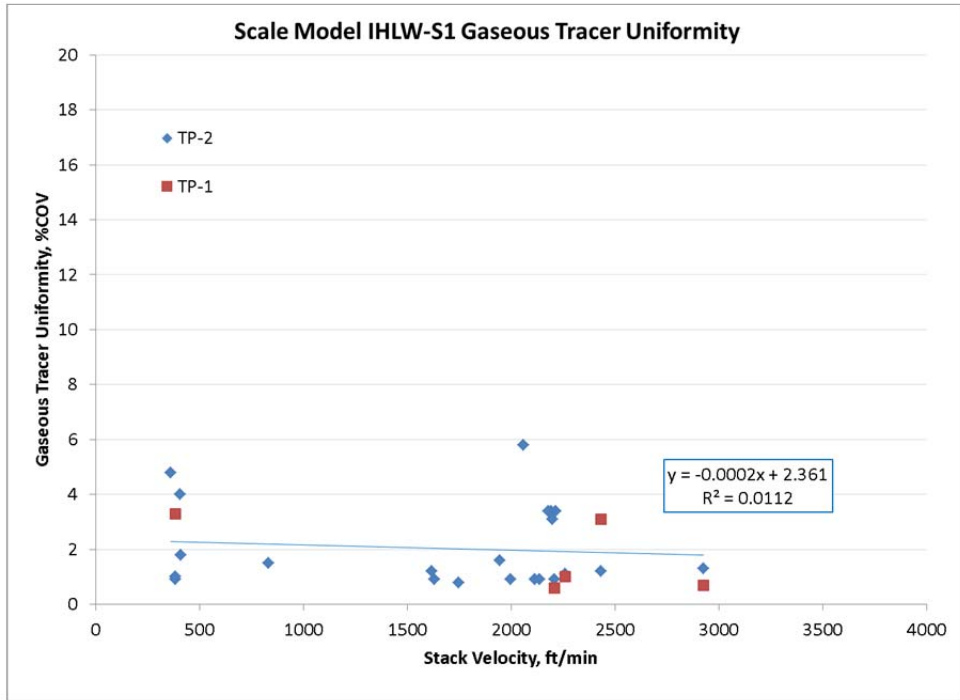

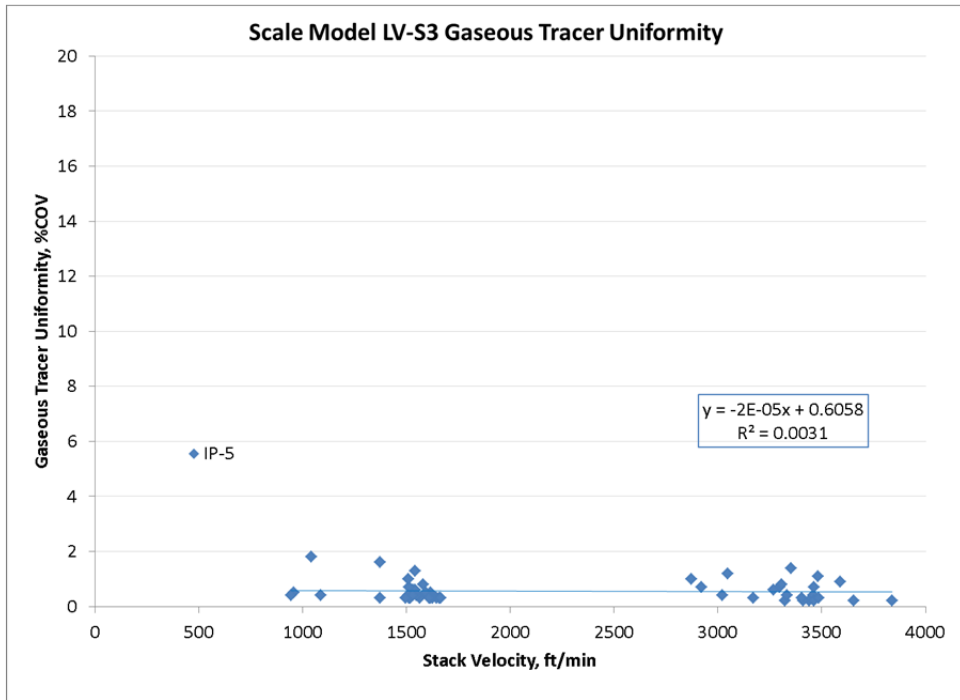
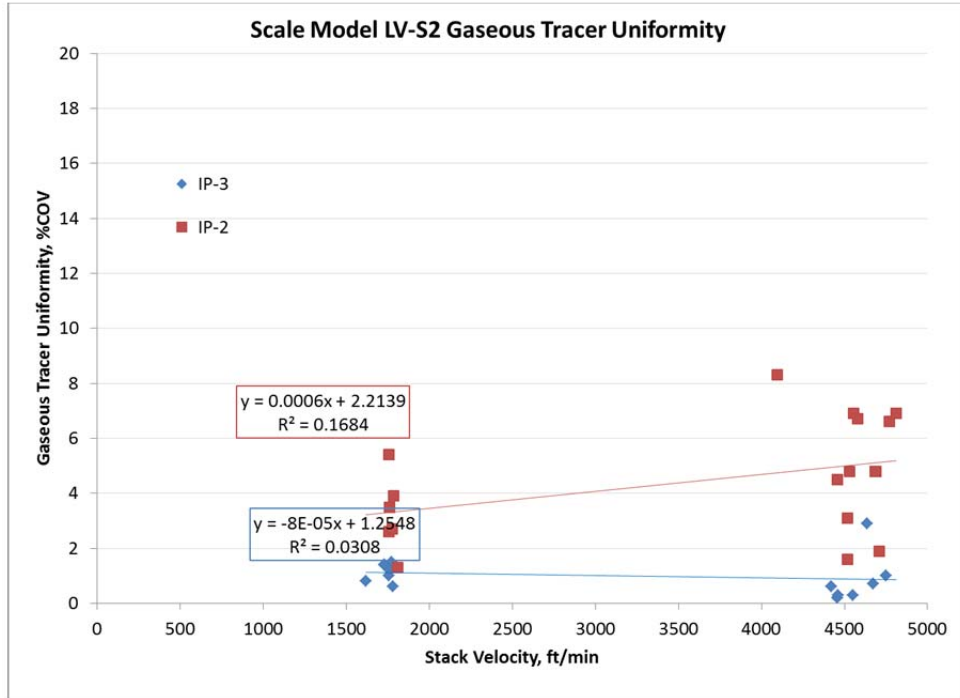

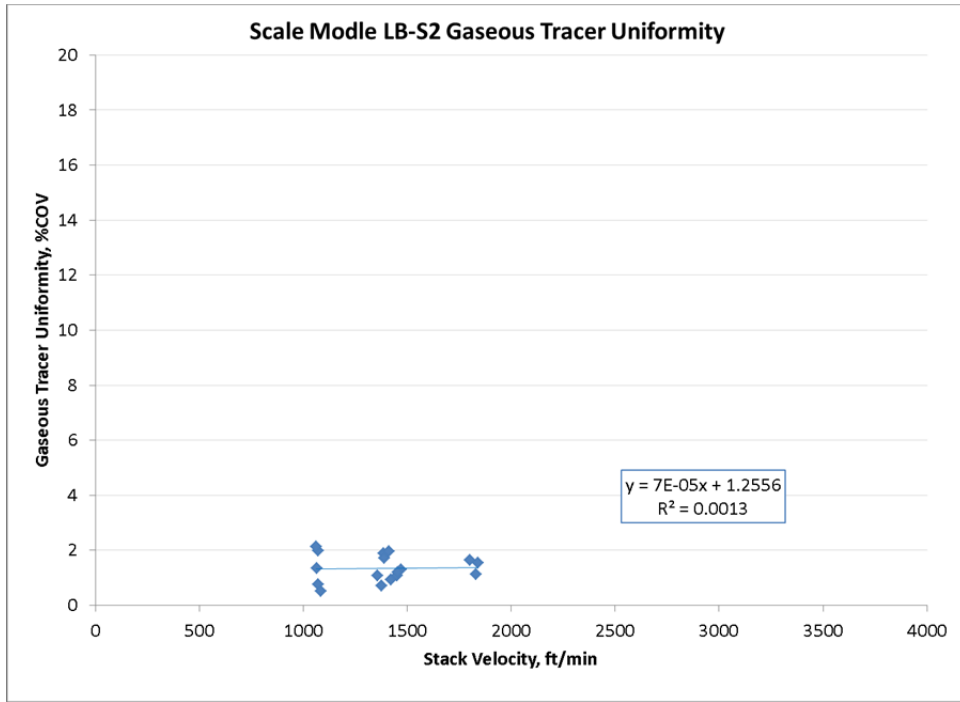
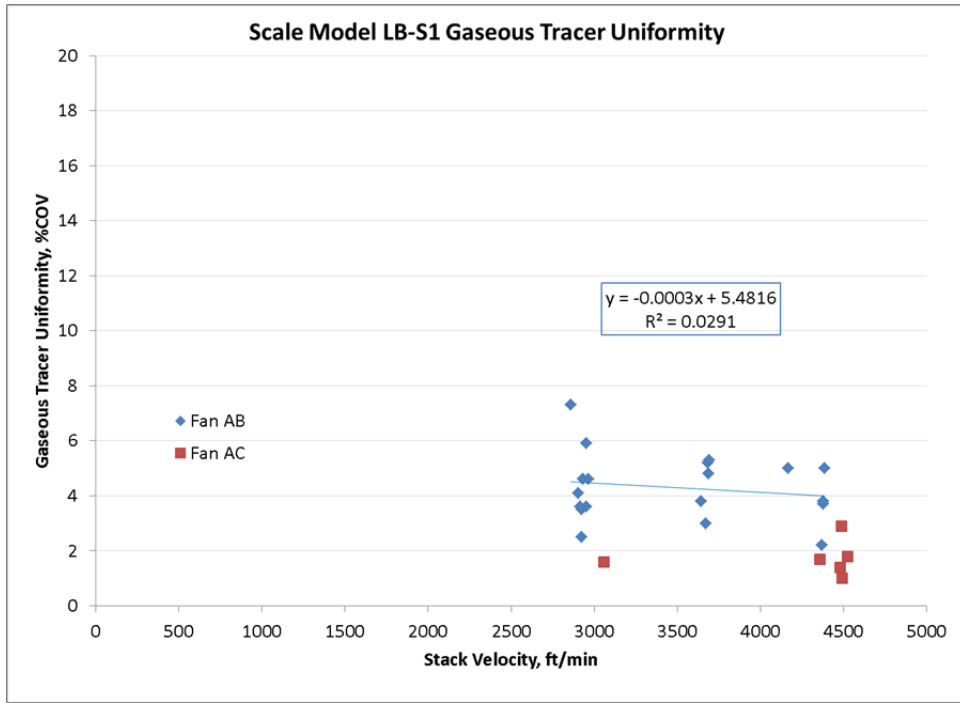

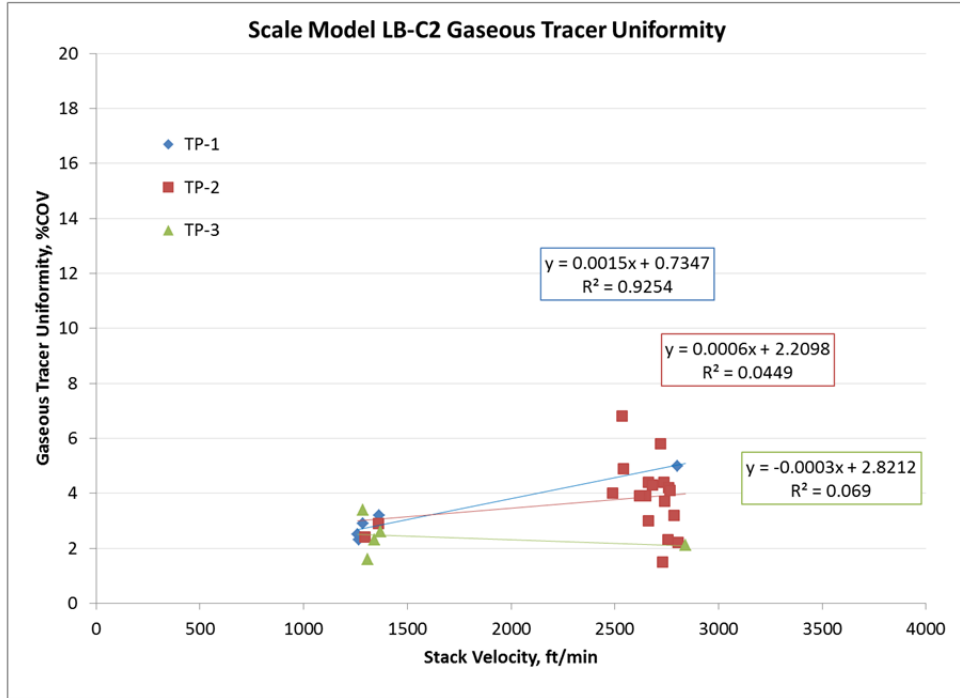

Stack	Slope Sign	Slope Value	R ²	N
HV-S1 (TP-2)	Positive	0.1%/1000 fpm	0.01	11
HV-S2	Positive	0.6%/1000 fpm	0.08	16
IHLW-S1 (TP-2)	Negative	0.2%/1000 fpm	0.01	22
LV-S1 (TP-2)	Positive	1.0%/1000 fpm	0.16	15
LV-S2 (IP-2)	Positive	0.6%/1000 fpm	0.17	18
LV-S3	Negative	<0.01%/1000 fpm	<0.01	51
LB-S1 (Fan AB)	Negative	0.3%/1000 fpm	0.03	19
LB-S2	Positive	<0.01%/1000 fpm	<0.01	17
LB-C2 (TP-2)	Positive	0.6%/1000 fpm	0.04	19

C.4 Particulate Tracer Uniformity Test Results

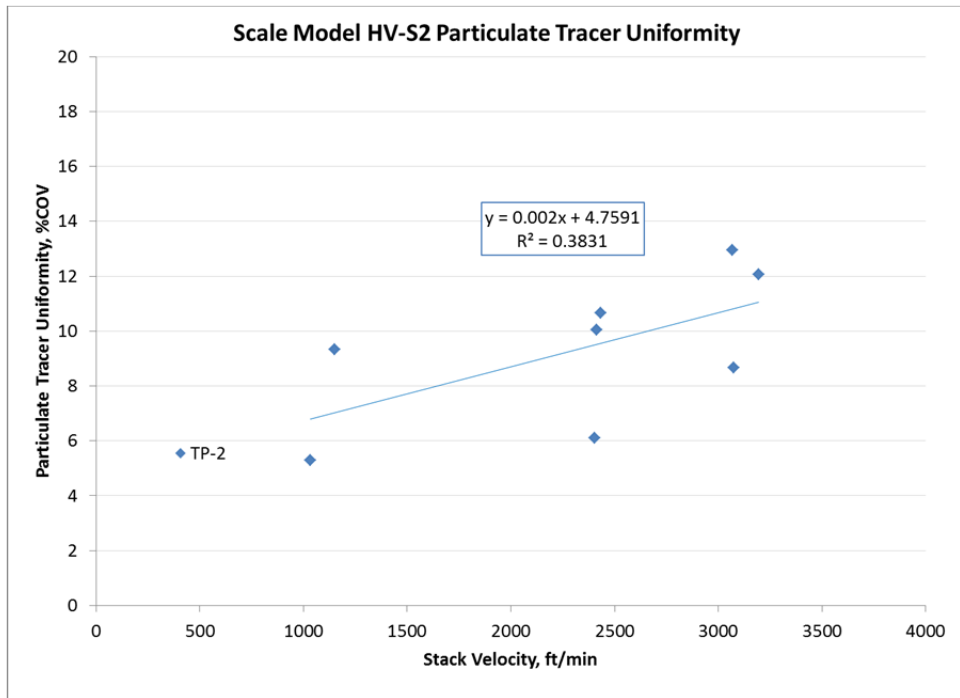
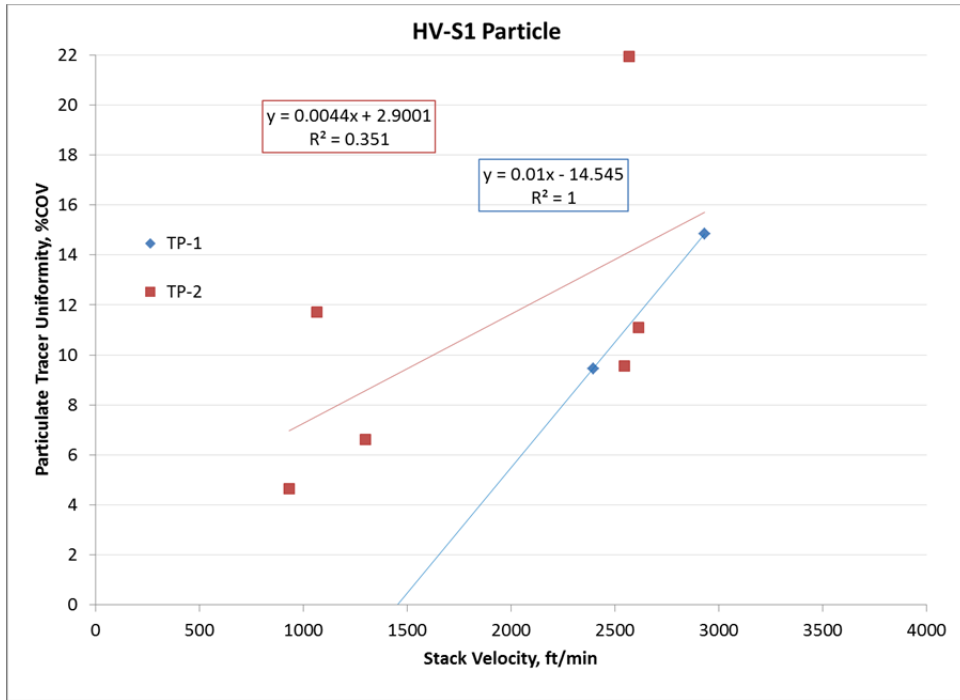

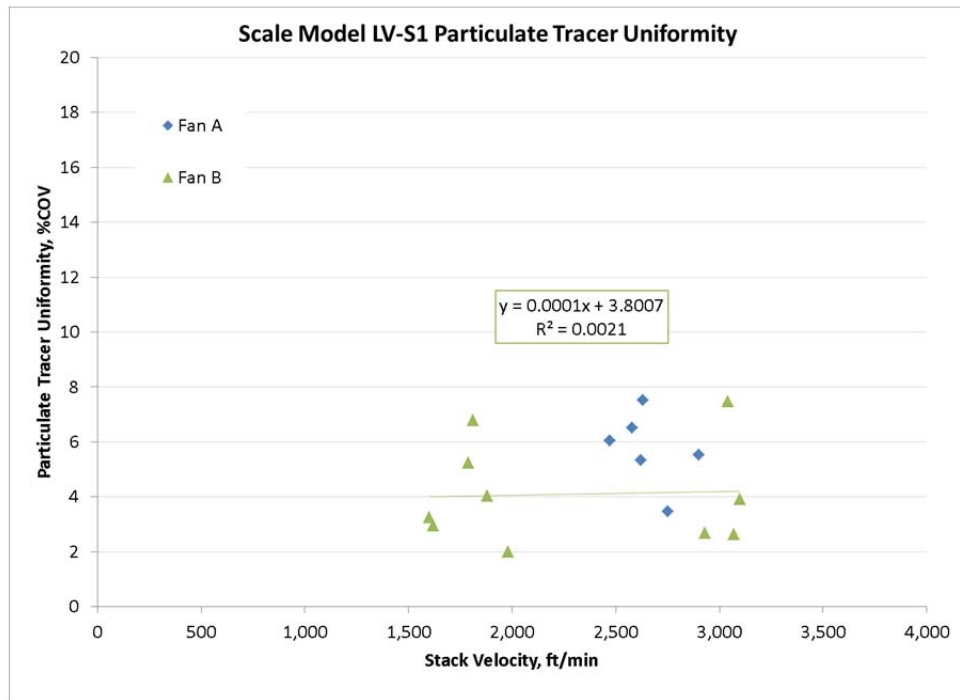
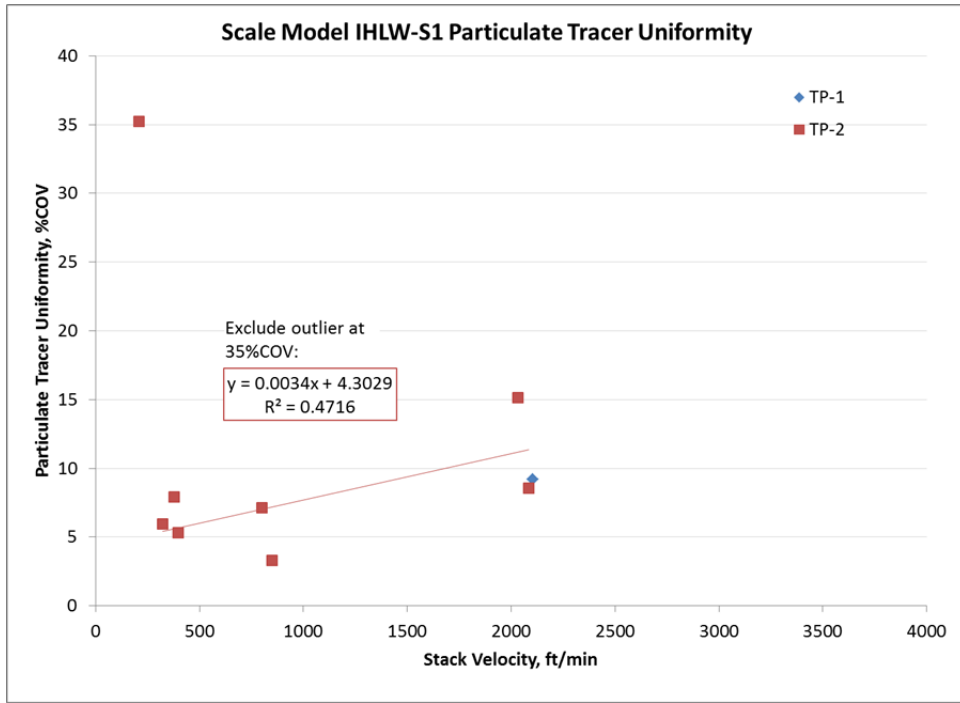

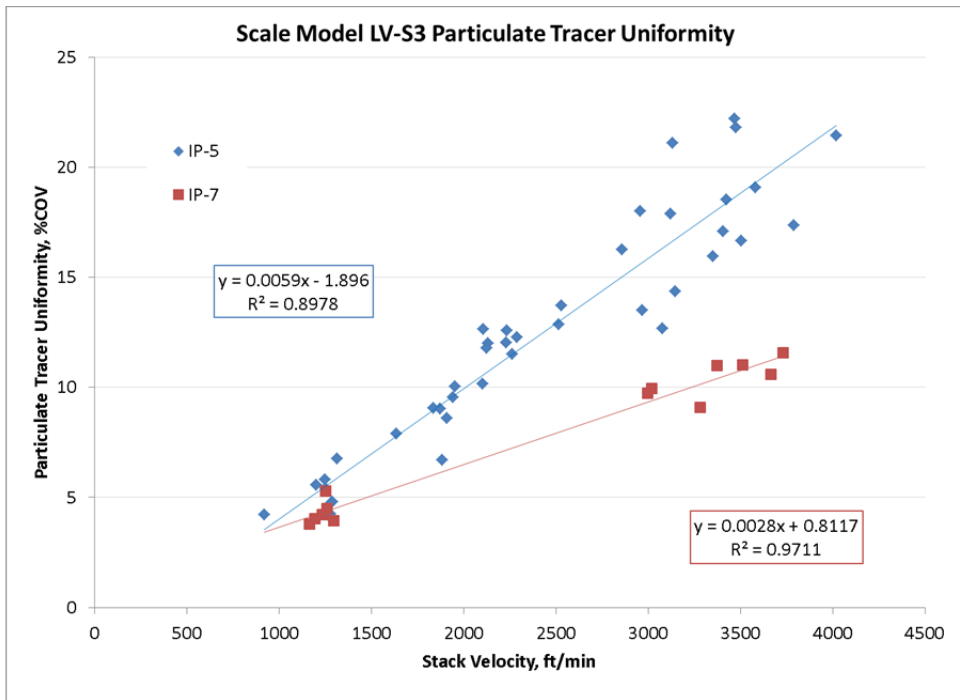
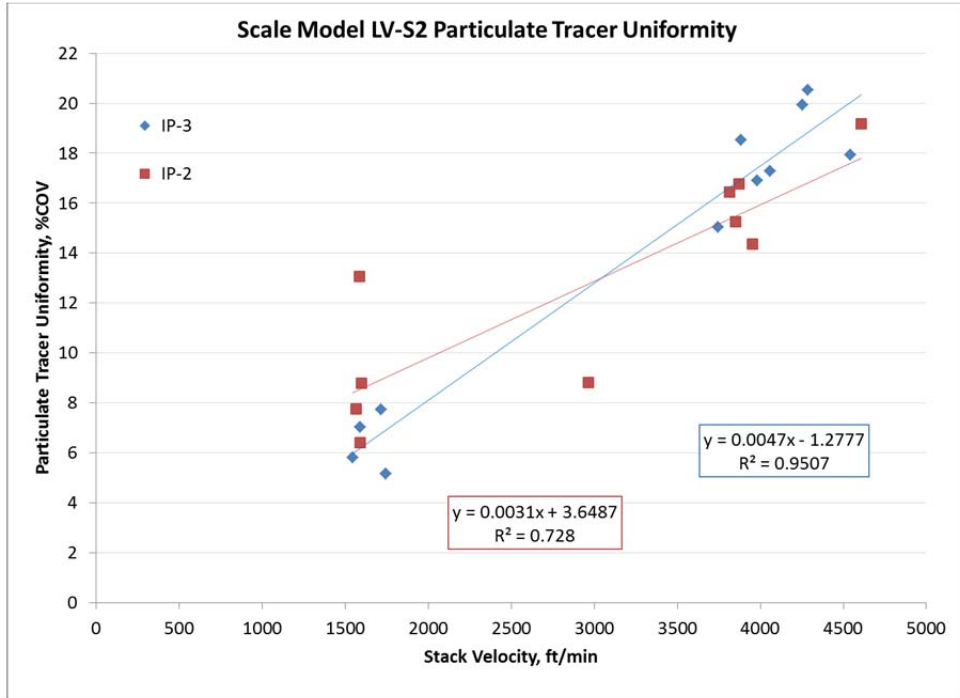

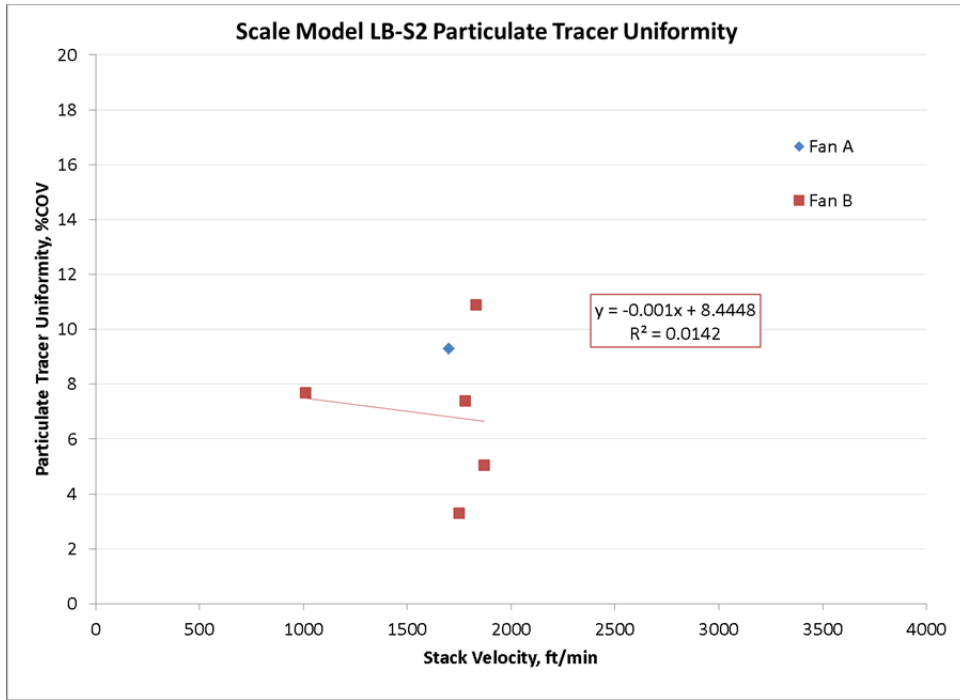
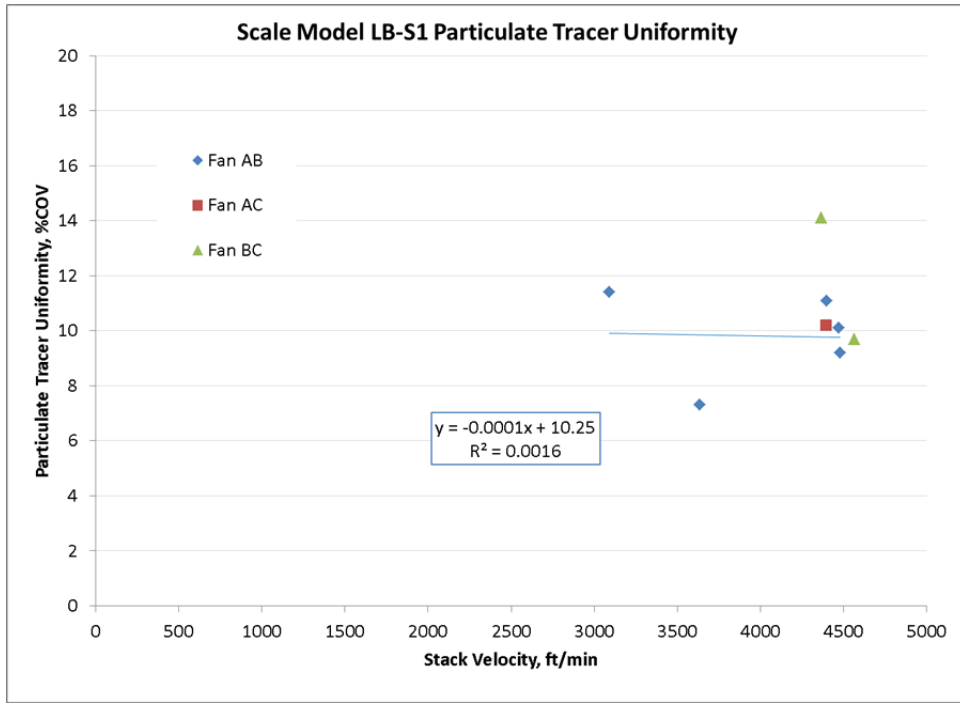

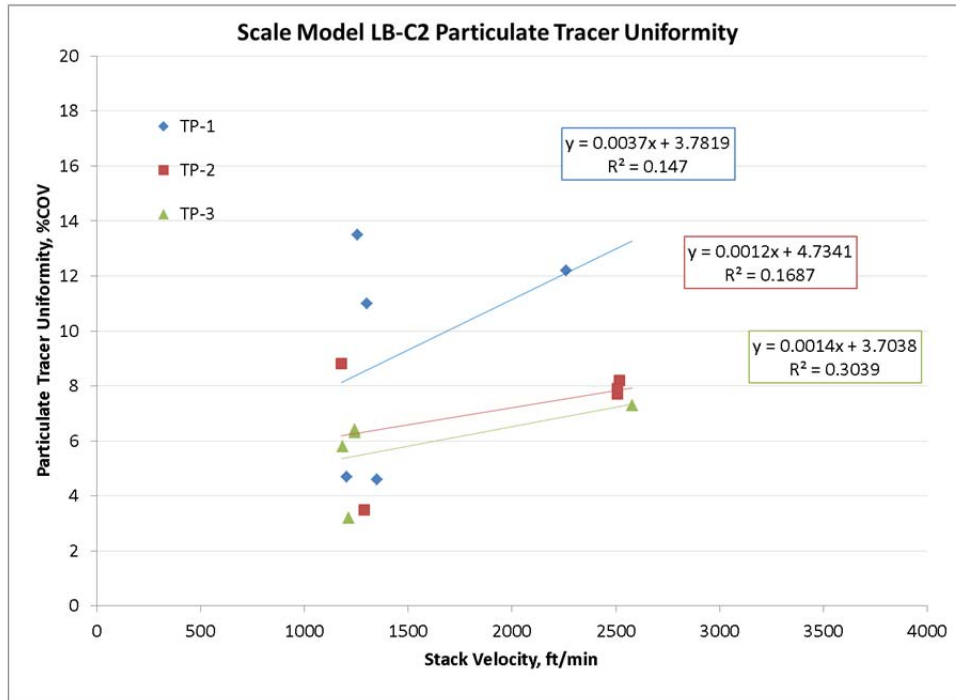

Stack	Slope Sign	Slope Value	R ²	N
HV-S1 (TP-2)	Positive	4.4%/1000 fpm	0.35	6
HV-S2	Positive	2.0%/1000 fpm	0.38	8
IHLW-S1 (TP-2)	Positive	3.4%/1000 fpm	0.47	7
LV-S1 (Fan B)	Positive	0.1%/1000 fpm	<0.01	10
LV-S2 (IP-3)	Positive	4.7%/1000 fpm	0.95	11
LV-S3 (IP-5)	Positive	5.9%/1000 fpm	0.90	42
LB-S1 (Fan AB)	Negative	0.1%/1000 fpm	<0.01	5
LB-S2 (Fan B)	Negative	1.0%/1000 fpm	0.01	5
LB-C2 (TP-2)	Positive	1.2%/1000 fpm	0.17	5

Distribution

**No. of
Copies**

**No. of
Copies**

3 CH2MHILL Plateau Remediation Company
SK Johansen (PDF)
PT Karschnia (PDF)
DJ Watson (PDF)

1 **Local Distribution**
Pacific Northwest National Laboratory
JE Flaherty (PDF) K9-24



Pacific Northwest
NATIONAL LABORATORY

*Proudly Operated by **Battelle** Since 1965*

902 Battelle Boulevard
P.O. Box 999
Richland, WA 99352
1-888-375-PNNL (7665)

U.S. DEPARTMENT OF
ENERGY

www.pnnl.gov